

## STYLE MWR WEAR RINGS

This wear ring is molded from glass reinforced nylon. This style is highly recommended because of their wear rate and non-scoring properties and their ability to ingest metal chips.

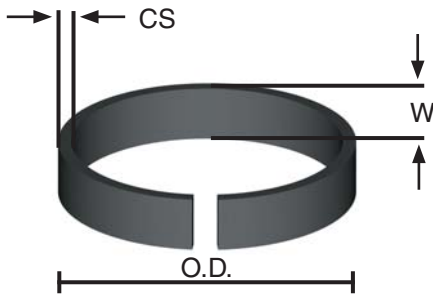

Suffix:  
SC = Scarf Cut Ring.

### SEAL INFORMATION

MATERIAL	NYLON
TEMPERATURE RANGE	-40° TO +275° F
COMPRESSIVE STRENGTH	26,000 PSI
TENSILE STRENGTH	25,000 PSI
PART NUMBER	(Prefix) - (OD) X (W) X (CS)

Part Number	List Price	Part Number	List Price	Part Number	List Price	Part Number	List Price
MWR-28X10X1.5	\$ 16.62	MWR-60X14.5X2.5	\$ 9.50	MWR-80X10X3.12	\$ 3.96	MWR-100X22.4X3-SC	\$ 24.18
MWR-32X4X1.5	13.83	MWR-60X19X3.17	16.14	MWR-80X13X2.5	8.92	MWR-100X25X3	14.45
MWR-35X8X2	6.05	MWR-60X20X2.5	9.62	MWR-80X15.5X3	10.33	MWR-100X28.3X3.24-SC	23.96
MWR-35X9.5X1.5	16.28	MWR-62X10X2	9.60	MWR-80X19.5X3	10.36	MWR-105X6X2.5-SC	31.16
MWR-35X15X1.5	20.19	MWR-63X5X3.1	13.77	MWR-80X20X2.5	21.29	MWR-105X10X4.5-SC	19.02
MWR-35X15.9X1.5	21.13	MWR-63X5.6X2.5	6.99	MWR-80X25X3	18.00	MWR-105X12.5X4.5	24.93
MWR-38X24.4X1.53-SC	18.87	MWR-63X12X2-SC	22.91	MWR-85X5.35X2.4-SC	14.38	MWR-105X15X3-SC	21.66
MWR-39X16X1.5	21.73	MWR-63X20X2.5	9.66	MWR-85X6X2.5-SC	24.76	MWR-105X24.5X3	13.30
MWR-40X12X2	13.57	MWR-65X10X2	17.14	MWR-85X9.5X2.5	30.93	MWR-105X25X3-SC	16.04
MWR-43X15.9X1.5	21.36	MWR-65X10X2.5	5.95	MWR-85X10X2-SC	12.35	MWR-105X40X3	26.25
MWR-45X14.5X3	7.47	MWR-65X15.5X3	9.30	MWR-85X14.5X3-SC	16.69	MWR-110X5.9X3-SC	17.92
MWR-45X20X2	14.29	MWR-68X25X1.5-SC	11.22	MWR-85X15X2.5-SC	14.82	MWR-110X7.9X2.5	9.85
MWR-48X22.5X1.5	22.90	MWR-69X30X3	19.78	MWR-85X25X2.5	29.40	MWR-110X7.9X3.12	10.92
MWR-50X5X3	7.58	MWR-70X9.5X2.4-SC	11.43	MWR-85X25.4X3.17	13.44	MWR-110X9.5X2.5-SC	16.10
MWR-50X9.5X2	8.33	MWR-70X10X2	3.24	MWR-85X29.9X3.25-SC	27.85	MWR-110X10X4.5-SC	20.67
MWR-50X9.5X2.5	8.57	MWR-70X10X3.12	3.94	MWR-86X25X3	8.79	MWR-110X12.5X2.75	23.36
MWR-50X10X2	6.99	MWR-70X14.5X3-SC	14.27	MWR-86X50X3	17.62	MWR-110X12.5X4.5	35.70
MWR-50X14.5X2	7.60	MWR-70X15.5X3	9.79	MWR-90X9.35X3.17-SC	9.03	MWR-110X15X3.1	23.76
MWR-50X14.8X2.5	15.21	MWR-70X19.5X3	12.51	MWR-90X10X4.5-SC	8.55	MWR-110X22.4X3-SC	24.75
MWR-50X19X3.17	14.79	MWR-70X20X2.5	8.64	MWR-90X12.5X3	9.99	MWR-110X25X3	18.45
MWR-50X20X2.5	8.35	MWR-71X9.7X2.5	8.15	MWR-90X12.5X4.5	24.23	MWR-110X30X3-SC	21.53
MWR-51X9.6X3	7.60	MWR-75X5.4X2.5-SC	10.04	MWR-90X15X3.15	4.79	MWR-115X5.8X4-SC	32.03
MWR-53X24.5X1.5	13.01	MWR-75X9.5X3.15	17.58	MWR-90X25X3	14.45	MWR-115X7.9X2.5	9.85
MWR-55X7.9X2.5	16.32	MWR-75X10X2	14.37	MWR-91X39.5X3	33.36	MWR-115X8X3.1-SC	21.37
MWR-55X10.5X3	7.65	MWR-75X12.7X3	8.94	MWR-95X9.85X4.5-SC	23.18	MWR-115X9.5X2.5	10.30
MWR-55X15.5X3	8.76	MWR-75X15X2	15.74	MWR-95X12.5X4.5	24.55	MWR-115X10X4.5-SC	12.23
MWR-55X20X2.5	12.20	MWR-75X25X3.15	14.73	MWR-95X15X2.5-SC	11.48	MWR-115X15X3	12.27
MWR-56X5X3.12	9.41	MWR-75X29.8X3.2-SC	17.64	MWR-99X13.9X3.6-SL	52.60	MWR-115X15X4.5	42.08
MWR-56X12.7X3	16.89	MWR-80X6X3.12	18.02	MWR-100X5.9X3-SC	16.82	MWR-120X5.9X3-SC	18.56
MWR-58X24.7X1.53-SC	13.52	MWR-80X9.35X3.17-SC	7.94	MWR-100X10X4.5-SC	8.73	MWR-120X7.9X2.5	10.60
MWR-60X12.7X3.17	15.68	MWR-80X10X2	20.82	MWR-100X15X3.15	13.30	MWR-120X10X4.5-SC	21.80

## STYLE MWR WEAR RINGS

WEAR RINGS

Part Number	List Price	Part Number	List Price	Part Number	List Price	Part Number	List Price
MWR-120X15.45X3	\$ 18.57	MWR-130X30X3.5	\$ 33.89	MWR-150X12.2X6-SC	\$ 58.41	MWR-185X22.5X6	\$ 69.66
MWR-120X15X3-SC	28.84	MWR-130X40X3.5-SC	52.99	MWR-150X14.8X3.5	16.27	WWR-190X9.2X4-SC	11.92
MWR-120X15X4.5	44.57	MWR-135X7.75X4-SC	32.16	MWR-150X17.5X6	38.10	MWR-190X28.5X4-SC	47.66
MWR-120X20X3.12-SC	13.62	MWR-135X7.9X2.5	12.40	MWR-150X20.9X3.5-SC	20.33	MWR-190X45X4	72.51
MWR-120X22.4X3-SC	27.13	MWR-135X9.85X3.85	28.88	MWR-150X35X3.5	50.19	MWR-190X55X4-SC	75.80
MWR-120X30X3	22.36	MWR-135X10X5	41.81	MWR-150X45X3.5-SC	57.64	MWR-200X20X3.12	27.79
MWR-120X35X3-SC	42.83	MWR-135X14.8X3.5	14.61	MWR-160X15X6-SC	22.68	MWR-200X22X4	19.67
MWR-120X40X3	28.44	MWR-135X15X5	48.88	MWR-160X20X3.12	16.50	MWR-200X22.5X4	35.70
MWR-125X7.9X2.5	10.94	MWR-135X18.3X3.5-SC	7.38	MWR-160X20X3.5	42.47	MWR-200X22.5X6	64.60
MWR-125X10X3.1-SC	19.10	MWR-140X7.9X2.5	12.88	MWR-160X20X6	61.56	MWR-200X45X4	26.62
MWR-125X10X5-SC	20.16	MWR-140X9.5X2.5	20.24	MWR-160X20.3X3.5-SC	33.42	MWR-200X60X3.25-SC	153.55
MWR-125X15X3	28.96	MWR-140X10X3.12	11.64	MWR-160X40X3.5	52.33	MWR-220X60X3.25-SC	161.64
MWR-125X15X5-SC	23.99	MWR-140X12.5X6-SC	20.22	MWR-160X45X3.5-SC	60.52	MWR-224X45X4	73.98
MWR-125X20X3	17.40	MWR-140X17.5X6-SC	55.23	MWR-170X9.35X4-SC	56.15	MWR-225X25X4	72.41
MWR-125X20X3.12	17.40	MWR-140X20X3.12	18.15	MWR-170X20X6-SC	75.46	MWR-225X25X6	81.88
MWR-130X7.9X2.5	11.80	MWR-140X20.35X3.5	44.35	MWR-170X25X3.8-SC	38.28	MWR-225X50X4	72.63
MWR-130X9.4X3.17-SC	10.51	MWR-140X35X3.5	10.67	MWR-170X50X4-SC	84.12	MWR-250X27.5X6	89.08
MWR-130X10X5-SC	18.13	MWR-140X45X3.5-SC	54.43	MWR-180X20X3	17.85	MWR-250X55X4	93.30
MWR-130X12X3	25.95	MWR-145X9.5X2.5	20.85	MWR-180X22.5X4	62.04	MWR-260X27.5X6	139.20
MWR-130X15X3.5-SC	26.54	MWR-145X9.7X3.85-SC	39.87	MWR-180X28.2X4-SC	45.82	MWR-280X60X4	128.87
MWR-130X15X5	45.03	MWR-145X12.2X6-SC	41.45	MWR-180X45X4	19.13	MWR-300X30X6	176.52
MWR-130X18.1X3.5	32.80	MWR-145X14.8X3.5	15.12	MWR-180X55X4-SC	95.19		

# STYLE MWRB WEAR RINGS

Fabricated from fine woven fabric and phenolic resins, this wear ring is strong yet light weight with an excellent wear rate.

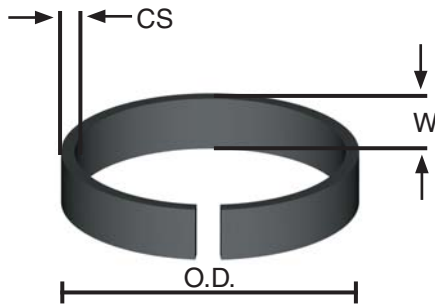

Suffix:  
SC = Scarf Cut Ring.

## SEAL INFORMATION

MATERIAL	PHENOLIC
TEMPERATURE RANGE	-40° TO +250° F
COMPRESSIVE STRENGTH	34,000 PSI
TENSILE STRENGTH	10,600 PSI
PART NUMBER	(Prefix) - (OD) X (W) X (CS)

Part Number	List Price	Part Number	List Price	Part Number	List Price
MWRB-30X10X2.5-SC	\$ 4.75	MWRB-50X14.5X2	\$ 7.13	MWRB-62X25X3	\$ 10.61
MWRB-35X10X2	3.82	MWRB-50X15X2.5	7.24	MWRB-63X5.6X2.5-SC	3.46
MWRB-35X16X1.5-SC	4.17	MWRB-50X20X2.5	8.92	MWRB-63X9.7X2.5	6.85
MWRB-36X9.5X2-SC	4.18	MWRB-50X30X2.5-SC	7.57	MWRB-63X15X2.5	9.64
MWRB-36X20X2	7.86	MWRB-51X22.5X3	12.67	MWRB-65X15X2.5-SC	5.64
MWRB-37X10X2.5-SC	5.32	MWRB-55X7.9X2.5	4.45	MWRB-65X15.5X3	10.92
MWRB-39X25X2	12.51	MWRB-55X9.7X2.5	5.17	MWRB-65X19.7X2.5	10.02
MWRB-40X5.5X2.5-SC	2.24	MWRB-55X10X2-SC	4.23	MWRB-65X25X2.5	12.69
MWRB-40X9.5X2.5	5.68	MWRB-55X14.7X2.5-SC	8.55	MWRB-68X9.7X2.5	8.21
MWRB-40X9.7X2-SC	4.97	MWRB-55X15X2.5	8.92	MWRB-68X25X2.5-SC	8.19
MWRB-41X9.7X2.5-SC	3.34	MWRB-55X15.5X3	12.67	MWRB-69X31.5X3-SC	9.08
MWRB-44X9.7X2	7.61	MWRB-55X20X2.5	10.12	MWRB-70X5.3X2.5-SC	3.59
MWRB-44X40X2	15.27	MWRB-55X29.5X2.5-SC	7.31	MWRB-70X6.8X2.5-SC	3.68
MWRB-45X14.5X3	8.78	MWRB-55X30X2.5-SC	8.33	MWRB-70X9.5X2.5-SC	4.81
MWRB-45X15X2.5-SC	4.01	MWRB-55X35X2.5-SC	11.32	MWRB-70X10X2-SC	5.58
MWRB-45X20X2.5	8.25	MWRB-55X5.4X2.5-SC	3.40	MWRB-70X10X2.5	4.23
MWRB-46X20X3	8.78	MWRB-55X9.5X2.5-SC	6.33	MWRB-70X12X2.5	5.78
MWRB-49X8X2-SC	3.85	MWRB-56X25X3	10.23	MWRB-70X12.4X3	5.78
MWRB-49X25X2	6.59	MWRB-58X30X4-SC	11.46	MWRB-70X14.5X2.5	10.15
MWRB-50X5X2.5	3.14	MWRB-60X7X2.5-SC	3.85	MWRB-70X15X2.5	10.15
MWRB-50X6X2.5-SC	3.10	MWRB-60X9.5X2.5	5.90	MWRB-70X15X3-SC	9.15
MWRB-50X6X5-SC	3.85	MWRB-60X9.7X2.5-SC	4.62	MWRB-70X15.5X3	9.15
MWRB-50X6.8X2.5	5.52	MWRB-60X10X2-SC	4.23	MWRB-70X19.5X3	13.72
MWRB-50X9X2.5	4.16	MWRB-60X10X2.5	7.24	MWRB-70X20X2.5	10.74
MWRB-50X9.7X2-SC	3.85	MWRB-60X12.7X3	8.63	MWRB-70X30X2.5	13.72
MWRB-50X9.7X2.5	7.61	MWRB-60X14.5X2.5-SC	8.05	MWRB-70X35X2.5-SC	8.98
MWRB-50X10X1.9-SC	6.46	MWRB-60X15X2.5-SC	5.39	MWRB-75X9.5X2.5-SC	4.77
MWRB-50X10X2.5	6.52	MWRB-60X18X2.5-SC	4.64	MWRB-75X10X2.5	8.69
MWRB-50X12.6X3.3	6.66	MWRB-60X20X2.5	8.43	MWRB-75X14.5X2.5	10.66

# STYLE MWRB WEAR RINGS

WEAR RINGS

Part Number	List Price	Part Number	List Price	Part Number	List Price
MWRB-75X15X2.5	\$ 10.66	MWRB-90X24.6X3-SC	\$ 22.78	MWRB-105X24.5X4	\$ 15.22
MWRB-75X19.6X3-SC	11.32	MWRB-90X25X3	16.87	MWRB-110X5.9X4-SC	12.61
MWRB-75X20X2.5-SC	10.86	MWRB-95X6X2.5	8.32	MWRB-110X6X2.5	10.86
MWRB-75X30X2.5	15.07	MWRB-95X7.9X2.5	9.04	MWRB-110X7.9X2.5	9.88
MWRB-75X45X2.5-SC	14.24	MWRB-95X9.5X2.5	9.76	MWRB-110X9.5X2.5	10.61
MWRB-75X50X2.5-SC	15.40	MWRB-95X9.7X2.5	8.63	MWRB-110X12.5X3	10.94
MWRB-76X31.5X3.12-SC	14.14	MWRB-95X9.7X4-SC	8.72	MWRB-110X14.8X2.5	13.00
MWRB-76X35X3-SC	10.50	MWRB-95X10X2-SC	5.78	MWRB-110X15X2.5-SC	8.72
MWRB-80X9.7X2.5-SC	4.74	MWRB-95X12.4X3-SC	6.00	MWRB-110X15X3-SC	14.54
MWRB-80X10X2-SC	4.62	MWRB-95X12.5X3-SC	4.57	MWRB-110X15X4	18.10
MWRB-80X10X2.5	4.81	MWRB-95X14.8X2.5	12.67	MWRB-110X15X5-SC	9.23
MWRB-80X10X3-SC	2.76	MWRB-95X14.8X4-SC	15.66	MWRB-110X25X3	19.53
MWRB-80X14.5X2.5	10.66	MWRB-95X15X2.5	12.69	MWRB-110X30X3	21.69
MWRB-80X15X2.5-SC	6.28	MWRB-96X29X3-SC	16.07	MWRB-113X20X4-SC	18.08
MWRB-80X15X3-SC	6.80	MWRB-100X5.9X4-SC	12.61	MWRB-115X7.9X2.5	10.02
MWRB-80X15.5X3	10.61	MWRB-100X6X2.5-SC	9.27	MWRB-115X9.5X2.5	10.86
MWRB-80X15.7X3-SC	4.17	MWRB-100X7.9X2.5	9.30	MWRB-115X9.7X3-SC	9.36
MWRB-80X19.5X3	12.30	MWRB-100X9.5X2.5	10.13	MWRB-115X10X4.5-SC	14.75
MWRB-80X20X2.5	11.67	MWRB-100X9.6X2.5	9.14	MWRB-115X14.8X2.5	13.49
MWRB-80X20X2.5-SC	16.63	MWRB-100X10X3-SC	4.25	MWRB-115X15X3-SC	14.29
MWRB-80X24.6X3-SC	16.63	MWRB-100X12.5X3	10.86	MWRB-115X15X4-SC	10.14
MWRB-85X5.5X2.5	3.00	MWRB-100X12.5X4.5-SC	9.88	MWRB-115X15X4.5	15.91
MWRB-85X9.7X2.5-SC	3.63	MWRB-100X12.8X2.5	9.34	MWRB-115X24.7X4	15.73
MWRB-85X9.7X2.5	8.63	MWRB-100X14.7x2.5-SC	12.47	MWRB-118X30X4-SC	21.36
MWRB-85X12.5X3-SC	6.15	MWRB-100X14.8X2.5	12.40	MWRB-120X5.9X4-SC	13.49
MWRB-85X15X4-SC	3.79	MWRB-100X14.8X3	12.91	MWRB-120X7.9X2.5	10.36
MWRB-85X19.7X2.5	12.69	MWRB-100X20X3-SC	10.26	MWRB-120X9.5X2.5	11.57
MWRB-85X20X3-SC	7.48	MWRB-100X25X2.5-SC	14.07	MWRB-120X9.7X3-SC	7.57
MWRB-85X25X2.5-SC	16.63	MWRB-100X25X3	18.08	MWRB-120X12.4X3	8.90
MWRB-85X25X3-SC	16.63	MWRB-100X25X3-SC	18.08	MWRB-120X14.8X2.5	13.85
MWRB-85X35X2.5	20.24	MWRB-100X30X3	20.24	MWRB-120X14.8X3	13.99
MWRB-86X40X3	24.57	MWRB-100X30X3-SC	8.35	MWRB-120X14.8X3.5	13.99
MWRB-90X5X2.5	4.83	MWRB-100X40X3.12	32.98	MWRB-120X15X4.5	28.67
MWRB-90X6X4-SC	6.03	MWRB-101X39.5X3	10.36	MWRB-120X15X2.5	12.69
MWRB-90X9.7X2.5-SC	3.40	MWRB-104X25X4	15.22	MWRB-120X15X5-SC	11.67
MWRB-90X8X2.5-SC	8.72	MWRB-105X6X2.5	8.78	MWRB-120X25X2.5-SC	13.47
MWRB-90X10X3	10.50	MWRB-105X7.9X2.5	9.88	MWRB-120X25X3	18.80
MWRB-90X12.5X3	11.57	MWRB-105X9.5X2.5	10.61	MWRB-120X30X3	23.02
MWRB-90X12.5X4.5	21.45	MWRB-105X9.7X3-SC	7.18	MWRB-120X30X3.5	40.43
MWRB-90X15X2-SC	9.74	MWRB-105X14.8X2.5	12.76	MWRB-125X7.9X2.5	10.86
MWRB-90X15X2.5-SC	7.57	MWRB-105X15X3-SC	14.09	MWRB-125X9.5X2.5	11.57
MWRB-90X15X4-SC	8.60	MWRB-105X24.5X3	18.90	MWRB-125X9.7X3-SC	7.96

# STYLE MWRB WEAR RINGS

Part Number	List Price	Part Number	List Price	Part Number	List Price
MWRB-125X9.9X3-SC	\$ 11.57	MWRB-145X9.5X3.5	\$ 14.82	MWRB-165X15X4	\$ 21.69
MWRB-125X14.8X2.5	13.49	MWRB-145X14.8X2.5	17.10	MWRB-165X20X4	26.51
MWRB-125X14.8X3	17.73	MWRB-145X14.8X3.5	18.44	MWRB-165X30X3-SC	32.11
MWRB-125X14.8X3.5	17.73	MWRB-145X20X3.5-SC	19.64	MWRB-170X9.2X4-SC	7.57
MWRB-125X15X5-SC	11.67	MWRB-145X25X2.5-SC	16.03	MWRB-170X9.5X2.5	15.67
MWRB-125X16.8X3.5	7.17	MWRB-150X7.8X4-SC	13.89	MWRB-170X9.5X3-SC	16.87
MWRB-125X25X2.5-SC	13.47	MWRB-150X7.9X2.5	13.00	MWRB-170X14.8X2.5	19.53
MWRB-127X9.5X3	10.66	MWRB-150X9.5X2.5	14.11	MWRB-170X14.8X3.5	26.85
MWRB-128X30X4-SC	10.03	MWRB-150X14.8X2.5	17.59	MWRB-170X14.8X4-SC	28.20
MWRB-130X7.9X2.5	12.76	MWRB-150X14.8X3.5	19.05	MWRB-170X20X3.5-SC	28.89
MWRB-130X9.5X2.5	14.35	MWRB-150X20X2.5-SC	13.72	MWRB-170X25X4-SC	31.45
MWRB-130X10X3.5-SC	20.52	MWRB-150X20X3-SC	21.69	MWRB-170X40X3.5	45.79
MWRB-130X14.8X2.5	16.01	MWRB-150X20X3.5-SC	23.43	MWRB-175X25X2.5-SC	18.99
MWRB-130X14.8X3.5	17.35	MWRB-150X30X3.5-SC	20.14	MWRB-175X25X4-SC	29.00
MWRB-130X15X2.5-SC	10.52	MWRB-150X35X3.5	36.86	MWRB-175X40X4	46.01
MWRB-130X15X5	18.08	MWRB-150X40X3.5	36.99	MWRB-180X7.9X2.5	17.73
MWRB-130X25X2.5-SC	15.00	MWRB-150X42X3-SC	36.99	MWRB-180X9.5X2.5	17.73
MWRB-130X30X3	27.11	MWRB-155X7.9X2.5	15.67	MWRB-180X14.8X2.5	21.69
MWRB-130X30X3.5	27.84	MWRB-155X9.5X2.5	14.22	MWRB-180X14.8X3.5	28.14
MWRB-130X30X5-SC	20.39	MWRB-150X12.5X2.5-SC	14.21	MWRB-180X22X4	32.64
MWRB-135X7.9X2.5	12.19	MWRB-155X14.8X2.5	17.83	MWRB-180X22.5X6	38.33
MWRB-135X9.5X2.5	15.72	MWRB-158X23X5	20.30	MWRB-180X25X2.5	30.85
MWRB-135X9.8X3.5-SC	15.91	MWRB-160X7.9X2.5	50.36	MWRB-180X40X4	51.94
MWRB-135X14.8X2.5	16.38	MWRB-160X9.1X4	8.87	MWRB-180X45X4	56.77
MWRB-135X14.8X3.5	21.88	MWRB-160X9.5X2.5	15.29	MWRB-180X55X4	72.41
MWRB-135X15X5	25.63	MWRB-160X12.5X2.5-SC	11.03	MWRB-185X20X6-SC	25.01
MWRB-140X7.9X2.5	23.73	MWRB-160X14.8X2.5	21.76	MWRB-185X22.5X6	39.86
MWRB-140X9.5X2.5	13.99	MWRB-160X14.8X3.5	24.57	MWRB-185X32X3	19.79
MWRB-140X9.5X2.5-SC	13.99	MWRB-160X20X3-SC	24.43	MWRB-186X32X3	19.79
MWRB-140X10X3.5-SC	14.74	MWRB-160X20X3.5	24.83	MWRB-190X14.8X3-SC	30.38
MWRB-140X12X3-SC	15.18	MWRB-160X20X6	29.65	MWRB-190X15X2.5	22.52
MWRB-140X14.8X2.5	16.63	MWRB-160X24.5X2.5	17.26	MWRB-190X22.5X4-SC	22.57
MWRB-140X14.8X3.5	16.63	MWRB-160X25X2.5	26.87	MWRB-190X25X4-SC	34.65
MWRB-140X17.5X6	24.11	MWRB-160X35X2.5	26.76	MWRB-190X25X5-SC	21.93
MWRB-140X20X3.5	21.93	MWRB-160X35X3-SC	30.38	MWRB-200X9X4-SC	17.05
MWRB-140X20X4	34.81	MWRB-160X40X3.5	44.82	MWRB-200X9.7X2.5-SC	12.44
MWRB-140X30X3-SC	22.13	MWRB-160X50X3-SC	44.82	MWRB-200X15X4-SC	17.45
MWRB-140X35X3.5	35.07	MWRB-160X24.5X2.5	17.26	MWRB-200X22X4	35.67
MWRB-140X40X3.5	38.06	MWRB-165X9.5X2.5	15.44	MWRB-200X25X2.5	38.68
MWRB-140X50X3-SC	39.04	MWRB-165X9.7X3-SC	11.67	MWRB-200X25X3.5-SC	42.94
MWRB-145X7.9X2.5	15.09	MWRB-165X14.8X2.5	19.28	MWRB-200X45X4	66.40
MWRB-145X9.5X2.5	13.99	MWRB-165X14.8X3.5	21.21	MWRB-225X25X4	14.94

**STYLE MWRB WEAR RINGS**

<b>Part Number</b>	<b>List Price</b>
MWRB-225X45X4	\$122.56
MWRB-225X50X4	61.05
MWRB-230X28X4.5-SC	79.20

<b>Part Number</b>	<b>List Price</b>
MWRB-250X9.7X4-SC	\$ 50.79
MWRB-250X25X2.5	38.43
MWRB-250X27.5X6	66.52

<b>Part Number</b>	<b>List Price</b>
MWRB-280X30X6	\$ 99.54
MWRB-300X25X2.5	48.10
MWRB-400X25X2.5	76.18

## STYLE MWRT WEAR RINGS

Made from filled PTFE, these rings are suitable for light duty bearing service but are more often installed on the out-board ends of a piston to catch metal particles to protect the seal area.

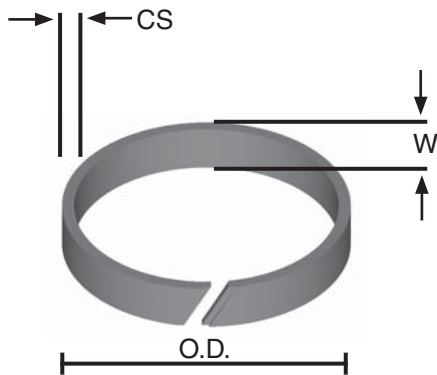

### SEAL INFORMATION

MATERIAL	FILLED PTFE
TEMPERATURE RANGE	-100° TO +550° F
COMPRESSIVE STRENGTH	1,700 PSI
TENSILE STRENGTH	2,200 PSI
PART NUMBER	(Prefix) - (OD) X (W) X (CS)

Part Number	List Price	Part Number	List Price	Part Number	List Price	Part Number	List Price
MWRT-55X11.8X4	\$ 46.26	MWRT-90X14.8X4	\$ 64.85	MWRT-130X8X4	\$ 25.21	MWRT-160X6X4-B4	\$ 56.05
MWRT-65X9.5X2.5	22.90	MWRT-95X6X4	19.09	MWRT-130X11.6X2.5	51.00	MWRT-160X9.7X4	35.30
MWRT-70X5.5X2.5-B4	34.49	MWRT-100X5.9X4-B4	36.65	MWRT-135X6X4	26.91	MWRT-165X6X4	60.16
MWRT-70X9.6X2.5	49.94	MWRT-100X14.8X4	71.08	MWRT-135X8X4	25.68	MWRT-165X9.7X4	69.73
MWRT-70X19.5X2.5	68.69	MWRT-105X6X4	48.35	MWRT-135X9.7X4	30.09	MWRT-170X6X4-SC	40.31
MWRT-75X11.8X4	49.71	MWRT-110X5.9X4	40.02	MWRT-140X8X4	26.01	MWRT-170X8X4-B4	67.81
MWRT-75X19.5X2.5	67.39	MWRT-110X5.9X4-B4	37.12	MWRT-140X9.7X4	31.08	MWRT-170X9.7X4	43.23
MWRT-80X4X4-SC	16.32	MWRT-110X14.8X4	71.66	MWRT-145X6X4	48.42	MWRT-175X6X4	62.18
MWRT-80X6X4-SC	31.96	MWRT-115X6X4	20.47	MWRT-145X7.9X4	40.91	MWRT-190X8X4	38.65
MWRT-80X11.8X4	57.35	MWRT-115X8X4	23.47	MWRT-145X7.9X4.5	52.02	MWRT-190X8.9X4-B4	44.96
MWRT-85X4X4-SC	16.32	MWRT-120X8X4	23.77	MWRT-145X9.7X4	32.91	MWRT-190X9.7X4	44.96
MWRT-85X19.5X2.5	62.38	MWRT-125X6X4	28.73	MWRT-150X6X4	7.25	MWRT-200X8.9X4-B4	93.91
MWRT-90X4.4X3.8	27.23	MWRT-125X8X4	24.77	MWRT-150X6X4-B4	47.80	MWRT-220X8.9X4-B4	99.35
MWRT-90X6X4	18.33	MWRT-125X9.7X4	53.87	MWRT-150X8X4	28.72		
MWRT-90X10X2.5	28.46	MWRT-130X4.75X4	42.03	MWRT-150X9.7X4	34.49		

## STYLE MWRA SC WEAR RINGS

The style MWRA wear ring is molded from acetal and has excellent wear characteristics.

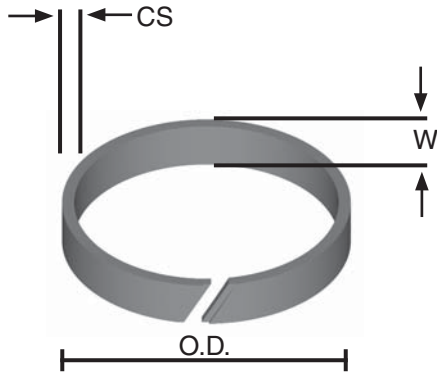

### SEAL INFORMATION

MATERIAL	ACETAL
TEMPERATURE RANGE	- 40° TO +230° F
PART NUMBER	(Prefix) - (OD) X (H) X (CS)

Part Number	O.D.	W	C/S	List Price
MWRA-29X9.5X2-SC	45	9.5	2	\$ 2.39
MWRA-45X9.5X2-SC	50	9.7	2.5	3.44
MWRA-50X9.7X2.5-SC	61	9.5	3	4.01
MWRA-61X9.5X3-SC	65	6.2	2.5	7.92
MWRA-65X6.2X2.5-SC	65	9.7	2.5	8.12
MWRA-65X9.7X2.5-SC	70	6.2	2.5	8.31

Part Number	O.D.	W	C/S	List Price
MWRA-70X6.2X2.5-SC	80	6.2	2.5	\$ 8.80
MWRA-80X6.2X2.5-SC	80	9.7	2.5	10.15
MWRA-80X9.7X2.5-SC	95	6.2	2.5	11.41
MWRA-95X6.2X2.5-SC	97	9.7	2.5	12.63
MWRA-97X9.7X2.5-SC	100	6.2	2.5	12.67
MWRA-100X6.2X2.5-SC	29	9.5	2	13.08

## STYLE MGF FLEXIBLE GUIDE BEARINGS



Fabricated from woven fabric and polyester resins, this material can be cut to length to fit rod or piston grooves.

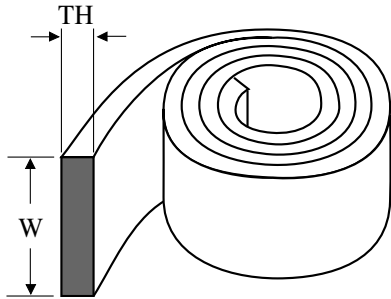

### SEAL INFORMATION

MATERIAL	FABRIC REINFORCED POLYESTER
TEMPERATURE RANGE	-30° TO +265° F
COMPRESSIVE STRENGTH	24,000 PSI
PART NUMBER	(Prefix) - (W) X (TH)

Part Number	List Price
MGF-5.6X2.5	\$ 14.37
MGF-9.7X2.5	15.01

Part Number	List Price
MGF-13X2.5	\$ 17.81
MGF-15X2.5	18.80

Part Number	List Price
MGF-20X2.5	\$ 24.97
MGF-25X2.5	25.76

## STYLE MGB FLEXIBLE GUIDE BEARINGS

Manufactured to a large variety of widths and thicknesses, this material affords low friction capabilities but with low compressive strength. The material also has the capability of ingesting metal particles and keeping them from the seal area.

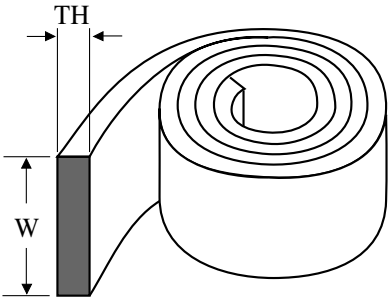

### SEAL INFORMATION

MATERIAL	60% BRONZE FILLED PTFE
TEMPERATURE RANGE	-50° TO +390° F
COMPRESSIVE STRENGTH	1,700 PSI
PART NUMBER	(Prefix) - (W) X (TH)

Part Number	List Price
MGB-4X2.5	\$ 9.79
MGB-5.5X2.5	12.17
MGB-6X4	13.25
MGB-6.1X2.5	12.06
MGB-7.9X2.5	12.06

Part Number	List Price
MGB-7.9X4	\$ 25.19
MGB-8X2	19.19
MGB-8.9X4*	30.25
MGB-9.5X2.5	15.17
MGB-9.5X4	24.94

Part Number	List Price
MGB-10X2	\$ 16.52
MGB-12X4	33.29
MGB-14X3.5	23.28
MGB-14.5X4	37.74
MGB-15X2	13.40

Part Number	List Price
MGB-15X2.5	\$ 19.64
MGB-20X2	14.65
MGB-20X2.5	22.81
MGB-30X2.5	24.94
MGB-50X2	30.48

\* 40% Bronze Filled PTFE.

# STYLE MDU ROD BUSHINGS

With a steel body, bronze liner, and PTFE / lead overlay, these bushings possess excellent wearability and tremendous compressive strength.

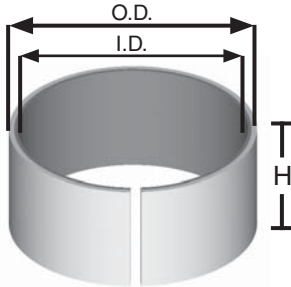

Suffix:  
C - Copper O.D.  
finish, electroplated

## SEAL INFORMATION

MATERIAL	BRONZE LINING PTFE/LEAD OVERLAY STEEL BACKING
TEMPERATURE RANGE	-325° TO +536° F
COMPRESSIVE STRENGTH	44,000 PSI
PART NUMBER	(Prefix) - (ID) X (OD) X (H)

WEAR RINGS

Part Number	List Price	Part Number	List Price	Part Number	List Price	Part Number	List Price
MDU-6X8X6	\$ 1.35	MDU-55X60X30-C	\$ 15.04	MDU-80X85X60	\$ 35.96	MDU-110X115X50-C	\$ 36.50
MDU-16X18X15	2.18	MDU-55X60X35-C	17.26	MDU-85X90X30	28.26	MDU-110X115X50	68.78
MDU-20X23X15	2.98	MDU-55X60X40	15.86	MDU-85X90X40	30.17	MDU-110X115X55	71.58
MDU-20X23X25	4.00	MDU-55X60X50	19.00	MDU-85X90X50	32.81	MDU-110X115X60	73.48
MDU-20X23X40	5.60	MDU-55X60X60	22.09	MDU-85X90X70	42.41	MDU-115X120X35	40.86
MDU-22X25X20	3.38	MDU-60X65X15	7.25	MDU-90X95X20	25.92	MDU-115X120X45	50.04
MDU-25X28X15	3.27	MDU-60X65X30	15.18	MDU-90X95X30	27.25	MDU-115X120X50	54.03
MDU-25X28X20	3.38	MDU-60X65X35	16.77	MDU-90X95X30-C	29.87	MDU-120X125X20	39.98
MDU-25X28X25	4.45	MDU-60X65X35-C	18.57	MDU-90X95X35	32.02	MDU-120X125X35	39.58
MDU-25X28X30	4.92	MDU-60X65X40	19.70	MDU-90X95X40	34.79	MDU-120X125X40	52.91
MDU-25X28X40	6.03	MDU-60X65X50	21.87	MDU-90X95X40-C	31.30	MDU-120X125X50	60.96
MDU-30X34X12	5.17	MDU-60X65X70	28.58	MDU-90X95X45	36.23	MDU-120X125X60	67.45
MDU-30X34X25	6.03	MDU-65X70X15	10.30	MDU-90X95X60	43.56	MDU-125X130X35	45.89
MDU-30X34X40	8.24	MDU-65X70X30	17.67	MDU-95X100X30	30.69	MDU-125X130X50	62.52
MDU-32X36X40	7.67	MDU-65X70X35	18.37	MDU-95X100X35	34.42	MDU-130X135X35	57.94
MDU-35X39X25	6.69	MDU-65X70X40	20.89	MDU-95X100X40	36.11	MDU-130X135X40	60.75
MDU-35X39X50	11.60	MDU-65X70X60	27.02	MDU-95X100X40-C	37.92	MDU-130X135X50	64.51
MDU-38X42X32	8.30	MDU-70X75X15	16.47	MDU-95X100X50	38.86	MDU-130X135X50-C	42.03
MDU-40X44X25	7.59	MDU-70X75X20	17.56	MDU-100X105X20	23.66	MDU-130X135X60	70.19
MDU-40X44X30	8.89	MDU-70X75X30	19.95	MDU-100X105X30	33.92	MDU-130X135X80	76.30
MDU-40X44X40	8.94	MDU-70X75X40	24.03	MDU-100X105X35	42.07	MDU-135X140X60	79.14
MDU-40X44X50	12.93	MDU-70X75X40-C	22.45	MDU-100X105X40	42.41	MDU-140X145X35	83.61
MDU-45X50X20	7.59	MDU-70X75X50	26.34	MDU-100X105X40-C	33.37	MDU-140X145X40	81.41
MDU-45X50X30	10.43	MDU-75X80X30	22.07	MDU-100X105X50	48.45	MDU-140X145X50	86.50
MDU-45X50X50	14.52	MDU-75X80X35	22.90	MDU-100X105X60	50.46	MDU-140X145X55	88.05
MDU-50X55X12	6.69	MDU-75X80X40	25.21	MDU-105X110X35	36.18	MDU-140X145X60	88.42
MDU-50X55X25	10.55	MDU-75X80X40-C	24.55	MDU-105X110X40	38.14	MDU-140X145X70	96.02
MDU-50X55X30	12.64	MDU-75X80X50	27.69	MDU-105X110X40-C	37.72	MDU-150X155X40	86.75
MDU-50X55X40	15.63	MDU-75X80X60	33.49	MDU-105X110X50	46.21	MDU-150X155X60	88.75
MDU-50X55X50	17.41	MDU-80X85X15	24.74	MDU-105X110X60	52.03	MDU-160X165X40	93.05
MDU-50X55X60	20.32	MDU-80X85X30	25.44	MDU-110X115X20	33.92	MDU-160X165X50	96.49
MDU-55X60X12	6.93	MDU-80X85X40	27.65	MDU-110X115X35	37.32	MDU-180X185X90	129.32
MDU-55X60X25	11.17	MDU-80X85X40-C	29.03	MDU-110X115X40	42.88		
MDU-55X60X30	14.93	MDU-80X85X50	31.49	MDU-110X115X45	48.21		

## STYLE MRB ROD BUSHINGS

Molded from a sturdy nylon material, these bushings are found chiefly in Ford metric cylinders.

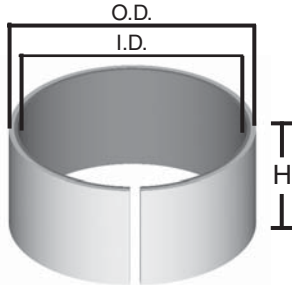

Part Number	List Price
MRB-50X56X18	\$ 8.08
MRB-50X56X28	8.08
MRB-56X62X28	8.65
MRB-63X69X28	9.22

### SEAL INFORMATION

MATERIAL	NYLON
TEMPERATURE RANGE	-40° TO +250° F
COMPRESSIVE STRENGTH	25,000 PSI
TENSILE STRENGTH	27,000 PSI
PART NUMBER	(Prefix) - (ID) X (OD) X (H)

## STYLE MWRA-L ROD BUSHINGS

Primarily a British design, this ring can be installed one or two in a groove. Excellent wear characteristics.

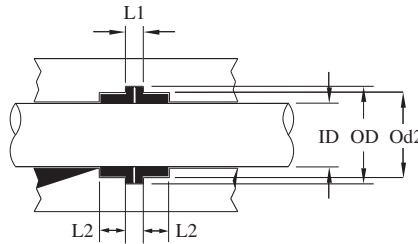

### SEAL INFORMATION

MATERIAL	ACETAL
TEMPERATURE RANGE	-40° TO +230° F
PART NUMBER	(Prefix) - (ID) X (OD) X (H)

Part Number	ID	OD	Od2	L1	L2	List Price
MWRA-45X53X18-L	45	53	18			\$ 1.62
MWRA-60X68X18-L	60	68	18			2.88
MWRA-60X71X16-L	60	71	66	10	11	3.14
MWRA-75X83X18-L	75	83	18			4.96
MWRA-78X89X16-L	78	89	84	10	11	3.68
MWRA-92X100X18-L	92	100	18			3.61

Part Number	ID	OD	Od2	L1	L2	List Price
MWRA-99X110X16-L	99	110	105	10	11	\$ 5.58
MWRA-120X131X16-L	120	131	126	10	11	6.48
MWRA-141X152X16-L	141	152	147	10	11	7.02
MWRA-162X173X16-L	162	173	168	10	11	7.69
MWRA-183X194X16-L	183	194	189	10	11	8.93
MWRA-207X218X16-L	207	218	213	10	11	11.06

## STYLE MBB PISTON BUSHINGS

Installed as 2 halves in a closed groove, these bushings are found in many Japanese lift trucks.

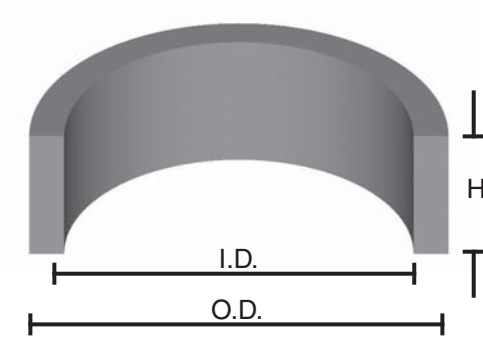

### SEAL INFORMATION

MATERIAL	660 BRONZE
PART NUMBER	(Prefix) - (ID) X (OD) X (H)

Part Number	List Price
MBB-60X80X19.6	\$ 68.50
MBB-70X90X24.6	73.71
MBB-85X105X24.6	77.78

# STYLE WRFAI WEAR RINGS

WRFAI split bearings are manufactured of an extremely abrasion-resistant and low-friction POM-PTFE Bronze compound. The excellent dry-running properties allow installation behind the primary rod seal. The WRFAI utilizes a scraper edge for integrated wiping function and contaminant removal. These are genuine Hunger® parts.

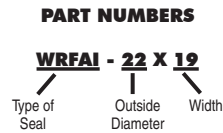
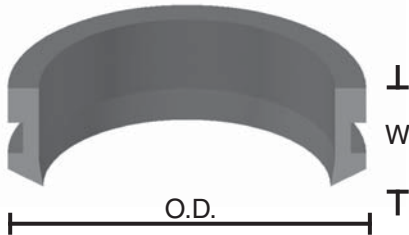

## SEAL INFORMATION

MATERIAL	POM - PTFE / BZ
TEMPERATURE RANGE	-65° TO +248° F
PART NUMBER	(Prefix) - (ID) X (W)

Part Number	OD	W	List Price
WRFAI 22X19	22	19	\$ 11.73
WRFAI 25X19	25	19	11.73
WRFAI 28X19	28	19	14.13
WRFAI 32X19	32	19	17.44
WRFAI 35X19	35	19	18.04
WRFAI 36X19	36	19	18.04
WRFAI 40X19	40	19	23.81
WRFAI 45X19	45	19	24.95
WRFAI 50X19	50	19	24.05
WRFAI 55X19	55	19	24.05
WRFAI 56X19	56	19	31.39
WRFAI 60X24	60	24	30.06
WRFAI 63X24	63	24	29.16
WRFAI 65X24	65	24	30.06
WRFAI 70X24	70	24	36.98
WRFAI 75X24	75	24	30.06
WRFAI 80X24	80	24	30.36
WRFAI 90X24	90	24	36.08
WRFAI 100X24	100	24	45.16

Part Number	OD	W	List Price
WRFAI 110X24	110	24	\$ 49.42
WRFAI 115X24	115	24	55.32
WRFAI 120X24	120	24	62.53
WRFAI 125X24	125	24	60.13
WRFAI 130X24	130	24	66.38
WRFAI 140X24	140	24	65.24
WRFAI 150X35	150	35	85.08
WRFAI 160X35	160	35	96.81
WRFAI 180X35	180	35	105.22
WRFAI 190X35	190	35	108.23
WRFAI 200X35	200	35	143.10
WRFAI 220X35	220	35	150.32
WRFAI 225X35	225	35	182.19
WRFAI 240X35	240	35	201.43
WRFAI 250X35	250	35	210.45
WRFAI 260X35	260	35	232.99
WRFAI 270X35	270	35	240.51
WRFAI 290X35	290	35	300.64

## STYLE WRFA WEAR RINGS

WRFA bearings are manufactured of an extremely abrasion-resistant and low-friction POM-PTFE Bronze compound. Rings are split for easy installation and multiple rings may be arranged adjacent to each other with joints staggered. These are genuine Hunger® parts.

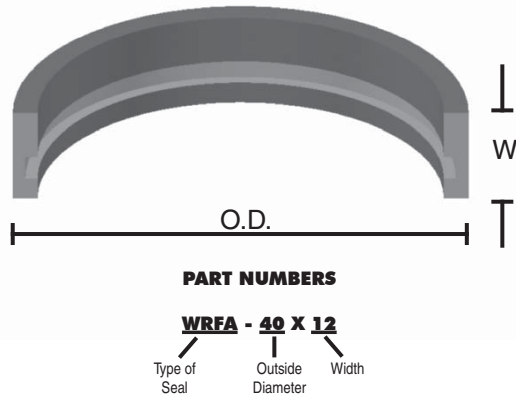

### SEAL INFORMATION

MATERIAL	POM - PTFE / BZ
TEMPERATURE RANGE	-65 TO +248° F
PART NUMBER	(Prefix) - (OD) X (W)

Part Number	OD	W	List Price
WRFA 40X12	40	12	\$ 19.24
WRFA 50X12	50	12	22.85
WRFA 60X12	60	12	27.66
WRFA 60X8.5	60	8.5	33.37
WRFA 63X12	63	12	29.46
WRFA 63X8.5	63	8.5	33.37
WRFA 70X12	70	12	30.91
WRFA 70X8.5	70	8.5	34.27
WRFA 75X12	75	12	31.27
WRFA 80X10.5	80	10.5	41.49
WRFA 80X14	80	14	32.47
WRFA 90X10.5	90	10.5	41.49
WRFA 90X14	90	14	40.89
WRFA 100X10.6	100	10.6	41.49
WRFA 100X14	100	14	49.00
WRFA 105X14	105	14	47.50
WRFA 110X10.5	110	10.5	41.49
WRFA 110X14	110	14	49.00
WRFA 115X14	115	14	3.01
WRFA 120X10.5	120	10.5	42.09
WRFA 120X14	120	14	52.31
WRFA 125X12.5	125	12.5	43.29
WRFA 125X17.5	125	17.5	51.71
WRFA 130X12.6	130	12.6	44.49
WRFA 130X17.5	130	17.5	60.13
WRFA 140X12.6	140	12.6	45.70
WRFA 140X17.5	140	17.5	63.43
WRFA 150X17.5	150	17.5	79.37
WRFA 155X17.5	155	17.5	78.17
WRFA 160X12.6	160	12.6	48.10

Part Number	OD	W	List Price
WRFA 160X17.5	160	17.5	\$ 98.48
WRFA 165X20	165	20	90.19
WRFA 170X17	170	17	111.24
WRFA 180X15.6	180	15.6	96.20
WRFA 180X20	180	20	101.37
WRFA 180X24	180	24	123.86
WRFA 190X12	190	12	132.28
WRFA 190X20	190	20	112.74
WRFA 200X12	200	12	132.28
WRFA 200X20	200	20	133.48
WRFA 220X18.5	220	18.5	150.32
WRFA 220X25	220	25	150.92
WRFA 225X18.5	225	18.5	150.32
WRFA 225X25	225	25	171.66
WRFA 230X25	230	25	171.66
WRFA 240X27.5	240	27.5	492.14
WRFA 240X33	240	33	184.59
WRFA 250X27.5	250	27.5	246.52
WRFA 250X33	250	33	197.82
WRFA 275X33	275	33	210.45
WRFA 280X27.5	280	27.5	248.93
WRFA 280X33	280	33	270.87
WRFA 300X33	300	33	247.24
WRFA 310X35	310	35	270.63
WRFA 320X35	320	35	297.63
WRFA 340X35	340	35	370.38
WRFA 380X35	380	35	387.52
WRFA 400X35	400	35	451.44
WRFA 480X35	480	35	511.08

# STYLE WRFI WEAR RINGS

WRFI bearings are manufactured of an extremely abrasion-resistant and low-friction POM-PTFE Bronze compound. The excellent dry-running properties allow installation behind the primary rod-seal. These are genuine Hunger® parts.

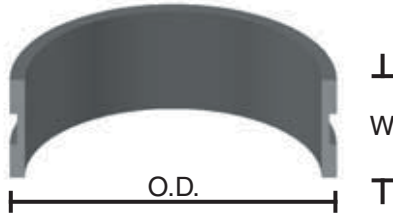

### PART NUMBERS

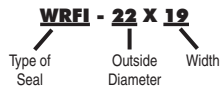

### SEAL INFORMATION

MATERIAL	POM - PTFE / BZ
TEMPERATURE RANGE	-65° TO +248° F
PART NUMBER	(Prefix) - (OD) X (W)

Part Number	OD	W	List Price
WRFI 22X19	22	19	\$ 10.52
WRFI 25X19	25	19	12.03
WRFI 28X19	28	19	12.03
WRFI 30X19	30	19	12.03
WRFI 35X19	35	19	18.04
WRFI 36X19	36	19	18.04
WRFI 40X19	40	19	22.01
WRFI 45X19	45	19	18.34
WRFI 50X19	50	19	24.05
WRFI 55X19	55	19	24.05
WRFI 56X19	56	19	24.65
WRFI 60X24	60	24	27.06
WRFI 63X24	63	24	27.96
WRFI 70X24	70	24	33.97
WRFI 80X24	80	24	39.08
WRFI 90X24	90	24	37.88
WRFI 95X24	95	24	42.99
WRFI 100X24	100	24	42.09
WRFI 105X24	105	24	56.22
WRFI 110X24	110	24	52.25

Part Number	OD	W	List Price
WRFI 115X24	115	24	\$ 53.81
WRFI 120X24	120	24	52.91
WRFI 125X24	125	24	53.51
WRFI 130X24	130	24	53.51
WRFI 140X24	140	24	57.12
WRFI 145X24	145	24	86.16
WRFI 150X35	150	35	68.24
WRFI 160X24	160	24	99.81
WRFI 160X35	160	35	85.68
WRFI 180X24	180	24	120.25
WRFI 180X35	180	35	117.85
WRFI 185X35	185	35	114.24
WRFI 190X35	190	35	114.24
WRFI 200X35	200	35	133.48
WRFI 220X35	220	35	157.23
WRFI 225X35	225	35	169.86
WRFI 240X35	240	35	203.53
WRFI 260X35	260	35	209.24
WRFI 270X35	270	35	216.46