

## BOBCAT® (MELROE)

Kit Number	Code (Pg. xviii)	Rod X Bore Size	List Price
BCK-7137963	I-U-10	1-3/4 X 3-1/4	\$ 36.69
BCK-7137966	I-U-10	2 X 3-1/4	35.03
BCK-7156581	I-U-10	1-3/4 X 3-1/4	36.69
BCK-7162060	I-U-10	1-3/4 X 3-1/4	36.69
BCK-7162061	I-U-10	1-3/4 X 3	44.50
BCK-7162062	I-U-10	1-1/2 X 2-3/4	44.15
BCK-749049	I-OB-3	1-1/2 X 2	11.61
BCK-M610	P-O-2	1-1/8 X 1-7/8	4.56

## BREAKER TECH

Kit Number	Code (Pg. xviii)	Rod X Bore Size	List Price
BTI-815-0457-ML	I-V-9	2-3/4 X 5	\$ 196.79
BTI-815-0468-ML	I-V-9	3-1/2 X 6	351.96

## CAMECO

Kit Number	Cylinder	Code (Pg. xviii)	Rod X Bore Size	List Price
CAM-017-1344693		N-N-14	100mm Piston Kit	\$ 23.66
CAM-017-1344694		P-UB-1	50mm Rod Kit	48.15
CAM-061-0007820		P-U-3	1-1/2 X 3-1/2	15.52
CAM-061-0021481		I-U-4	2-1/2 X 5	209.72
CAM-061-0297978		P-U-10	2-1/4 X 3	47.77
CAM-061-05021	001-05007	P-U-5	1-1/4 X 3	75.93
CAM-061-05835		P-U-3	1-1/4 X 2-1/2	14.09
CAM-061-06067	001-06063	P-OB-3	1-1/16 X 2-1/2	10.83
CAM-061-07221		I-V-5	2-1/2 X 7	142.34
CAM-061-08458	001-08459	I-U-5	2-1/2 X 4	81.23
CAM-061-08913		I-U-5	2-1/2 X 5	71.69
CAM-061-09619		P-U-3	2 X 4	28.76
CAM-061-1247081		P-U-1	3 Rod Kit	35.43
CAM-061-1304751		I-U-10	1-1/4 X 2-1/2	19.02
CAM-061-1309627		P-U-10	4 X 7	262.49
CAM-061-1347081		P-U-1	3 Rod Kit	35.43
CAM-061-1362725		I-U-10	1 X 2	13.05
CAM-061-21693		I-U-9	2-1/2 X 4	70.52
CAM-061-21699	001-21359	I-U-9	1-1/4 X 3	88.75
CAM-061-50139		P-V-3	1-1/4 X 3	27.58
CAM-061-53511		P-UB-10	2-1/2 X 4	59.77
CAM-061-53967	001-37224		1-1/4 Rod Kit	31.85
CAM-061-53968		P-U-1	1-1/2 Rod Kit	26.87
CAM-061-53970	001-89599		2-1/2 Rod Kit	34.79
CAM-061-53972	001-89576		3" Piston Kit	34.90
CAM-061-53973	001-89599		4" Piston Kit	35.38
CAM-061-53974		N-N-10	5" Bore	174.20
CAM-062-05672			Valve Kit	3.62
CAM-062-22730			Motor Kit	11.33

# CASCADE

Kit Number	Code (Pg. xviii)	Rod X Bore Size	List Price
CAS-552715	I-U-1	2-1/4 X 2-3/4	\$ 44.06
CAS-554289	MULTI STAGE	4, 5	150.77
CAS-560349	I-U-4	2" X 75 mm	95.17
CAS-562591	I-U-4	2" X 60 mm	76.07
CAS-615939	O-RING KIT		6.57
CAS-615940	O-RING KIT		8.66
CAS-628080	I-V-8	1-1/4 X 3	57.95
CAS-630033	I-U-3	1-1/2 X 4-3/4	29.58
CAS-630038	I-U-3	1-1/2 X 4-3/4	27.40
CAS-630445	I-V-8	1-1/4 X 2-1/2	50.86
CAS-631277	P-V-9	2 X 4-3/4	183.89
CAS-638884	MULTI STAGE	2-3/4, 3-3/4	94.29
CAS-639695	I-U-4	3/4 X 1-3/4	46.72
CAS-640371	I-O-4	4 X4-1/2	78.30
CAS-641956	MULTI STAGE	4, 5	128.59
CAS-643280	I-U-4	3 X 3-1/2	49.23

Kit Number	Code (Pg. xviii)	Rod X Bore Size	List Price
CAS-644690	I-U-5	1-3/4 X 4	\$ 91.52
CAS-646305	I-U-3	3-1/2 X 4	60.38
CAS-646339	SWIVEL KIT		5.92
CAS-647626	I-U-4	1 X 2-1/4	24.07
CAS-647892	I-V-8	1-3/4 X 4.520	81.73
CAS-650018	I-U-5	3-1/2 X 7	106.26
CAS-651847	I-N-4	2 X 2-1/2	36.96
CAS-654519	P-V-1	2 X 4-3/4	55.70
CAS-656167	MULTI STAGE	4-1/4, 5-7/16	176.61
CAS-658717	MULTI STAGE	2-3/4, 3-3/4	88.85
CAS-660954	I-U-4	1-5/8 X 3-1/2	52.58
CAS-660955	I-U-4	3 X 4	61.98
CAS-664814	N-U-4	3/4 X 1-3/4	25.06
CAS-667622	MULTI STAGE	2-1/2, 3-1/4, 4-1/2	169.00

## 45C VIEWMAST II

CAS-T555286	P-U-10	2-1/8 X 3	\$ 73.79
-------------	--------	-----------	----------

# REPLACEMENT PARTS FOR CASCADE

**NOTE:** Cascade part numbers are used as a reference only. We do not imply that these kits are original REPLACEMENT PARTS.

## FACE SEALS

Part Number	List Price
CAS-601468	\$ 2.14
CAS-607287	3.62

## RETAINER RINGS

Part Number	List Price
CAS-7197	\$ 2.49

## WEAR RINGS

Part Number	O.D. X Width	List Price
CAS-660761	2-1/4 X 1/2	\$ 4.01
CAS-660769	4 X 1/2	4.49
CAS-660784	4-3/4 X 3/4	5.27
CAS-660786	5-1/4 X 3/4	5.37
CAS-636959	5-3/4 X 3/4	6.91

## U-SEALS

Part Number	Rod Dia.	List Price
CAS-646540	3/4	\$ 4.72
CAS-641835	7/8	4.90
CAS-560502	1	5.10
CAS-662447	1	5.43
CAS-662450	1-3/8	6.19
CAS-662452	1-5/8	6.69
CAS-662454	1-7/8	7.50
CAS-553521	2-1/2	18.51
CAS-662462	3-1/2	14.56
CAS-553954	4-1/2	33.43
CAS-662457	2-1/4	9.72
CAS-553523	3	21.85
CAS-553524	3-1/4	22.89
CAS-662465	4-1/4	19.10
CAS-662467	4-3/4	21.81

## WIPERS

Part Number	Rod Dia.	List Price
CAS-559961	3/4	\$ 3.14
CAS-636851	7/8	1.16
CAS-636852	1	1.16
CAS-626468	1-1/4	1.26
CAS-636854	1-5/8	1.95
CAS-1916335	2-1/2	5.64
CAS-629608	2-1/2	2.39
CAS-636859	3	2.94
CAS-636860	3-1/4	3.46
CAS-563682	3-1/4	8.17
CAS-636862	4	3.95
CAS-563683	4-1/2	10.53
CAS-626456	4-1/2	4.28
CAS-636864	4-3/4	4.44
CAS-561256	42 mm	19.61



# REPLACEMENT PARTS FOR CASCADE EQUIPMENT

**NOTE:** Cascade part numbers are used as a reference only. We do not imply that these kits are original REPLACEMENT PARTS.

## O-RINGS

Part Number	Min. Pkgs.	List Price
CAS-1596	50	\$ 0.09
CAS-1912210	20	0.28
CAS-207300	50	0.06
CAS-208761	50	0.09
CAS-208762	50	0.21
CAS-208763	50	0.25
CAS-209063	15	0.77
CAS-209064	15	0.77
CAS-209065	15	0.79
CAS-209066	15	0.85
CAS-212359	50	0.11
CAS-2696	50	0.03
CAS-2697	50	0.03
CAS-2698	50	0.03
CAS-2699	50	0.03
CAS-2700	50	0.06
CAS-2701	50	0.07
CAS-2702	50	0.06
CAS-2703	50	0.07
CAS-2704	50	0.07
CAS-2705	50	0.07
CAS-2706	50	0.07
CAS-2707	50	0.09
CAS-2709	50	0.09
CAS-2712	50	0.12
CAS-2722	20	0.25
CAS-2753	5	2.03
CAS-2785	20	0.52
CAS-2787	20	0.38
CAS-2789	20	0.41
CAS-2792	20	0.51
CAS-2793	20	0.51
CAS-2797	20	0.63
CAS-2799	20	0.67
CAS-2801	20	0.69
CAS-2803	10	0.76
CAS-2804	10	0.82
CAS-2807	10	1.08
CAS-2808	10	1.11
CAS-2809	10	1.14

## O-RINGS

Part Number	Min. Pkgs.	List Price
CAS-2811	10	\$ 1.21
CAS-2840	50	0.21
CAS-524737	50	0.07
CAS-543372	10	1.39
CAS-557226	50	0.14
CAS-562127	20	0.61
CAS-564363	20	0.40
CAS-581565	50	0.28
CAS-613376	50	0.10
CAS-617724	50	0.12
CAS-622406	20	0.25
CAS-624737	50	0.07
CAS-624738	50	0.10
CAS-626186	50	0.10
CAS-626189	20	0.21
CAS-628033	20	0.18
CAS-630386	20	0.22
CAS-643330	50	0.06
CAS-643331	50	0.06
CAS-643332	50	0.06
CAS-643333	50	0.06
CAS-643334	50	0.06
CAS-643335	50	0.06
CAS-643336	50	0.06
CAS-643337	50	0.07
CAS-643338	50	0.07
CAS-643339	50	0.09
CAS-643340	50	0.09
CAS-643341	50	0.10
CAS-643342	50	0.10
CAS-643343	50	0.10
CAS-643344	50	0.10
CAS-643345	50	0.12
CAS-643346	50	0.12
CAS-643347	50	0.16
CAS-643348	50	0.18
CAS-643349	50	0.18
CAS-643350	20	0.18
CAS-643351	20	0.19
CAS-643352	20	0.22

## O-RINGS

Part Number	Min. Pkgs.	List Price
CAS-643353	20	\$ 0.25
CAS-643354	20	0.28
CAS-643355	20	0.35
CAS-643356	20	0.38
CAS-643357	20	0.38
CAS-643358	20	0.41
CAS-643359	20	0.41
CAS-643360	20	0.45
CAS-643361	20	0.46
CAS-643362	20	0.48
CAS-643363	20	0.55
CAS-643364	20	0.60
CAS-643365	20	0.63
CAS-643366	10	0.74
CAS-643367	10	0.76
CAS-643368	10	0.82
CAS-643369	10	0.91
CAS-643370	10	1.08
CAS-643371	10	1.39
CAS-643373	50	0.09
CAS-643374	50	0.10
CAS-643375	50	0.10
CAS-643376	50	0.10
CAS-643377	50	0.12
CAS-643378	50	0.12
CAS-643379	50	0.12
CAS-643380	50	0.18
CAS-643381	50	0.18
CAS-643382	20	0.19
CAS-643383	20	0.21
CAS-643384	20	0.22
CAS-643385	20	0.22
CAS-643386	20	0.25
CAS-643387	20	0.26
CAS-643388	20	0.26
CAS-643389	20	0.28
CAS-643390	20	0.28
CAS-643391	20	0.28
CAS-643392	20	0.29
CAS-643393	20	0.29

CASCADE

# REPLACEMENT PARTS FOR CASCADE EQUIPMENT

**NOTE:** Cascade part numbers are used as a reference only. We do not imply that these kits are original REPLACEMENT PARTS.

## O-RINGS

Part Number	Min. Pkgs.	List Price
CAS-643394	20	\$ 0.35
CAS-643395	20	0.35
CAS-643396	20	0.35
CAS-643397	20	0.41
CAS-643398	20	0.41
CAS-643399	20	0.41
CAS-643400	20	0.45
CAS-643401	20	0.45
CAS-645592	20	0.52
CAS-654926	50	0.18
CAS-655799	50	0.12
CAS-666015	50	0.21
CAS-666183	50	0.21
CAS-666184	50	0.14
CAS-666891	15	0.77
CAS-666892	10	0.85
CAS-666893	15	0.77
CAS-676959	15	0.75
CAS-682862	50	0.07
CAS-684587	50	0.11
CAS-684615	50	0.11
CAS-689937	50	0.11
CAS-689938	50	0.14
CAS-797089	20	0.53

## BACK-UP RINGS

Part Number	Min. Pkgs.	List Price
CAS-559870	1	\$ 10.76
CAS-563388	10	0.99
CAS-563907	1	2.75
CAS-563977	5	1.77
CAS-615009	25	0.37
CAS-615012	25	0.38
CAS-615126	10	0.56
CAS-615128	10	0.65
CAS-615130	10	0.78
CAS-615132	10	0.88
CAS-615135	10	1.01
CAS-615140	10	1.39
CAS-615146	5	2.14
CAS-615147	5	1.86
CAS-615150	5	2.15
CAS-615152	5	2.40
CAS-615217	1	4.10
CAS-637565	1	5.30
CAS-638223	1	7.15
CAS-638224	1	7.15
CAS-638225	1	7.45
CAS-638244	10	0.64
CAS-638245	1	5.24
CAS-638247	1	5.50
CAS-638249	1	5.74
CAS-638250	1	5.10
CAS-638252	1	6.32
CAS-638253	1	6.55
CAS-638256	1	7.33
CAS-638257	1	7.45
CAS-638293	1	6.13
CAS-638295	1	6.55
CAS-638298	1	7.45
CAS-648569	4	2.96
CAS-660952	1	6.55
CAS-669247	5	2.12
CAS-671754	10	0.86

## VEE SETS

Part Number	Bore	List Price
CAS-1469	3-1/2	\$ 40.34
CAS-1471	4-1/2	43.69
CAS-1809	1-3/4	17.52
CAS-1861	2-3/4	37.13
CAS-7501	1-3/8	20.17
CAS-7502	2	19.47
CAS-7514	3-3/4	36.63
CAS-7538	4	24.73
CAS-7542	3	20.97
CAS-7554	4-3/4	63.16
CAS-7561	4-1/4	68.72
CAS-7606	2-1/4	15.84
CAS-7608	3-1/2	20.86
CAS-7609	2-1/2	18.82
CAS-7636	4-1/4	38.98
CAS-827	4-1/2	49.81

CASCADE





# REPLACEMENT SEAL KITS FOR CASE EQUIPMENT\*

Replacement Seal Kits By Machine Type

## Table of Contents

<b>Machine Type</b>		<b>Page</b>
<b>Backhoe Loaders</b>	310LL, 430 with Backhoe Models 21, 22, 23, 480, 480B with Backhoe Models 23, 26, 26B, 26S, 480C, 480D, 480D LL, 480E, 480E LL, 480F, 480F LL, 530 with Backhoe Models 31, 32, 32S, 580 Super E, 580 Super K, 580 Super L, 580 Super L Construction King, 580 Super M, 580 Super M SERIES 3, 580 Super M+SERIES 3, 580 with Backhoe Models 33, 33S, 580B with Backhoe Model 35, 580C, 580C Construction King, 580D, 580 Super D, 580F, 580K, 580L, 580M, 590, 590 Super L, 590 Super M, 590 Super M SERIES 3, 590SR Super R, 590SR Super R Tier 2, 590SR Super R Tier 3, 680, 680B, 680C, 680CK, 680E, 680G, 680H, 680K, 680L, 780, 780B	<b>160 - 173</b>
<b>Crawler Dozers/Loaders</b>	310E, 310F with Backhoe Model 31, 310G with Backhoe Models 26, 26B, 26S, 32, 33, 350 with Backhoe Models 26, 26B, 26C, 26S, 350B with Backhoe Models 26C, 26D, 420C, 450 with Backhoe Models 26, 26B, 26C, 26S, 32, 33, 35, 450B, 450C, 455B, 455C with Backhoe Models 26D, 35, 475 Cable Layer, 550E, 550G, 550H, 650G, 650K, 750 with Backhoe Models 32, 33S, 34, 750H, 850 with Backhoe Models 34, 35, 36, 850B with Backhoe Model 35, 850C, 855C with Backhoe Models 35A, 35C, 35C WL, 35 WL, 850D with Backhoe Models 35C, 35C WL, 850E, 855E, 850G, 850H, 850K, 1150 with Backhoe Models 32, 34, 36, 1150B, 1150C, 1150D, 1155D, 1150G, 1150H, 1450, 1450B, 1455B	<b>173 - 185</b>
<b>Excavators</b>	880, 880B, 880C, 880D, 880R, 9010B, 9020B, 9030B, 9040B, CX130, CX135SR, CX160, CX210, CX240, CX330	<b>185 - 187</b>
<b>Loaders - Skid Steer</b>	40XT, 60XT, 70XT, 95XT, 1818, 1825, 1835, 1835B, 1835C, 1838, 1840, 1845, 1845S, 1845B, 1845C	<b>187 - 189</b>
<b>Loaders - Wheel</b>	521D, 621, 621B, 621C, 621D, 721, 721B, 721C, 721D, 821, 821B, 821C, 821E, 921, 921C, W3, W7, W7C, W7E, W8E, W9, W9A, W9B, W9C, W9E, W10, W10B, W10C, W10E, W11, W11B, W14, W14L, W14H, W14B, W18, W20, W20B, W18B, W20C, W24, W24B, W24C, W26B, W26FL, W30, W36	<b>189 - 195</b>
<b>Uni-Loaders</b>	1530B, 1700, 1816B, 1816C, 1818, 1825, 1830, 1835, 1835B, 1840, 1845, 1845B, 1845C, 1845S	<b>195</b>
<b>Unimogs</b>	MB4/94 with Model 26C Backhoe, P80 Cable Plow, T70	<b>195 - 196</b>
<b>Alpha-Numeric Kit Listing</b>		<b>197 - 200</b>
<b>Case Individual Parts</b>		<b>201 - 204</b>

CASE

\*All manufacturer's names, part numbers and descriptions are used for reference purposes only. We do not imply that any part shown is the product of these manufacturers. We also do not imply that the list price shown is exactly that of the manufacturer.



# CASE

Replacement Kits For

Backhoe Loaders								
APPLICATION	CYL #	Piston	SERIAL #	CODE	ROD	BORE	KIT #	List \$
<b>MODEL 380LL</b>								
LIFT		2pc		P-U-9	1-1/2	2-1/2	JIC-G32294	35.93
TILT		2pc		P-U-9	1-1/2	2-1/2	JIC-G32294	35.93
<b>MODEL 430 with Backhoe Models 21, 22, 23</b>								
BACKHOE BOOM				P-U-1	1-3/4		JIC-D42873	21.01
				P-U-1	1-3/4		JIC-D42872	15.33
		2pc		N-N-9		3-1/2	JIC-G33237	23.09
		2pc		N-N-9		3	JIC-G33151	20.85
BACKHOE BUCKET				I-U-1	2		JIC-D42874	16.35
		2pc		N-N-9		3	JIC-G33151	20.85
BACKHOE DIPPER				I-U-1	2		JIC-D42874	16.35
		2pc		N-N-9		3-1/2	JIC-G33237	23.09
		2pc		N-N-9		3	JIC-G33151	20.85
BACKHOE STABILIZER				P-U-1	1-1/4		JIC-D42867	19.12
		2pc		N-N-9		2-1/2	JIC-G33193	20.35
BACKHOE SWING				P-U-1	1-1/4		JIC-D42867	19.12
		2pc		N-N-9		2-1/2	JIC-G33193	20.35
LOADER LIFT				P-U-1	1-1/2		JIC-D42869	20.62
		2pc		N-N-9		2-1/2	JIC-G33193	20.35
LOADER TILT				P-U-1	1-1/2		JIC-D42870	20.47
		2pc		N-N-9		3	JIC-G33151	20.85
<b>MODEL 480, 480B with Backhoe Models 23, 26, 26B, 26S</b>								
3-PT HITCH LIFT		2pc		P-UB-9	1-1/2	3	JIC-G105512	52.15
3-PT HITCH PITCH		2pc		P-U-9	1-1/4	2-1/2	JIC-G32295	45.16
		1pc		P-U-10	1-1/4	2-1/2	JIC-G105507	26.36
3-PT HITCH TILT		2pc		P-U-9	1-1/4	2-1/2	JIC-G32295	45.16
BACKHOE BOOM		2pc		P-UB-9	1-3/4	3-1/2	JIC-G105529	41.78
		2pc		P-UB-9	2-1/4	4	JIC-G34636	59.90
				P-U-1	1-3/4		JIC-D42873	21.01
		2pc		N-N-9		3-1/2	JIC-G33237	23.09
BACKHOE BUCKET		2pc		P-UB-9	1-3/4	3	JIC-G105524	57.47
				P-U-1	1-1/2		JIC-D42870	20.47
				P-U-1	1-3/4		JIC-D42872	15.33
		2pc		N-N-9		3	JIC-G33151	20.85
BACKHOE DIPPER		2pc		P-U-9	2	3-1/2	JIC-G32293	40.26
		2pc		P-UB-9	2	3-1/2	JIC-G105527	52.45
				I-U-1	2		JIC-D42874	16.35
		2pc		N-N-9		3-1/2	JIC-G33237	23.09
BACKHOE DIPPER EXT		2pc		P-UB-9	1-1/2	3	JIC-G105512	52.15
BACKHOE STABILIZER		2pc		P-UB-9	1-3/4	3-1/2	JIC-G105529	41.78
		2pc		P-UB-9	1-3/4	3	JIC-G105524	57.47
		2pc		P-U-9	1-3/4	3-1/2	JIC-G105518	44.55
				P-U-1	1-1/2		JIC-D42870	20.47
				P-U-1	1-3/4		JIC-D42872	15.33
				P-U-1	1-1/4		JIC-D42867	19.12
		2pc		N-N-9		2-1/2	JIC-G33193	20.35
		2pc		N-N-9		3	JIC-G33151	20.85
BACKHOE SWING		2pc		P-UB-9	1-3/4	4	JIC-G105519	49.76
		2pc		P-U-9	1-1/2	3-1/2	JIC-G34652	39.20
				P-U-1	1-1/2		JIC-D47896	16.51
				P-U-1	1-1/4		JIC-D42867	19.12
		2pc		N-N-9		3-1/2	JIC-G33237	23.09
		2pc		N-N-9		2-1/2	JIC-G33193	20.35
LOADER LIFT		2pc		P-U-9	1-1/2	2-1/2	JIC-G32294	35.93
				P-U-1	1-1/2		JIC-D42869	20.62
		2pc		N-N-9		2-1/2	JIC-G33193	20.35



# CASE

Replacement Kits For

Backhoe Loaders								
APPLICATION	CYL #	Piston	SERIAL #	CODE	ROD	BORE	KIT #	List \$
<b>MODEL 480, 480B with Backhoe Models 23, 26, 26B, 26S</b>								
LOADER TILT		2pc		P-UB-9	1-1/2	3	JIC-G105512	52.15
		2pc		P-U-9	1-1/2	2-1/2	JIC-G32294	35.93
				P-U-1	1-1/2		JIC-D42870	20.47
		2pc		N-N-9		3	JIC-G33151	20.85
STEERING		1pc	87357171-	I-O-3	3/4	1-1/2	JIC-A44644	10.38
<b>MODEL 480C</b>								
3-PT HITCH LIFT		1pc		P-UB-10	1-1/2	3	JIC-G109452	29.65
		2pc		P-UB-9	1-1/2	3	JIC-G105512	52.15
3-PT HITCH PITCH		1pc		P-UB-10	1-1/4	2-1/2	JIC-G109476	31.93
3-PT HITCH TILT		1pc		P-UB-10	1-1/4	2-1/2	JIC-G109475	33.21
		2pc		P-U-9	1-1/4	2-1/2	JIC-G32295	45.16
BACKHOE BOOM		1pc		P-UB-10	2-1/4	4	JIC-G109505	46.61
		2pc		P-UB-9	2-1/4	4	JIC-G34636	59.90
BACKHOE BUCKET		1pc		P-UB-10	1-3/4	3	JIC-1543262C1	40.59
		2pc		P-UB-9	1-3/4	3	JIC-G109462	36.31
BACKHOE DIPPER		2pc		P-UB-9	2	3-1/2	JIC-G109454	34.85
		1pc		P-UB-10	2	3-1/2	JIC-G109453	43.95
BACKHOE DIPPER EXT		2pc		P-UB-9	1-1/2	3	JIC-G105512	52.15
		1pc		P-UB-10	1-1/2	3	JIC-G109452	29.65
BACKHOE STABILIZER		1pc		P-UB-10	1-3/4	3	JIC-1543262C1	40.59
		1pc		P-UB-10	1-3/4	3-1/2	JIC-G109471	42.84
		2pc		P-UB-9	1-3/4	3-1/2	JIC-G109470	38.50
		2pc		P-UB-9	1-3/4	3	JIC-G109462	36.31
BACKHOE SWING				P-U-9	1-1/2	3-1/2	JIC-G34652	39.20
		1pc		P-UB-10	1-1/2	3-1/2	JIC-G109472	40.50
LOADER LIFT		2pc		P-UB-9	1-1/2	2-1/2	JIC-G109484	41.75
		1pc		P-UB-10	1-1/2	2-1/2	JIC-1543253C1	43.06
LOADER TILT		2pc		P-UB-9	1-1/2	2-1/2	JIC-G109484	41.75
		1pc		P-UB-10	1-1/2	2-1/2	JIC-1543253C1	43.06
STEERING		1pc	-8980833	I-O-3	3/4	1-1/2	JIC-A44644	10.38
		1pc	8980834-	I-U-10	3/4	1-1/2	JIC-D148100	22.76
<b>MODEL 480D, 480D LL</b>								
3-PT HITCH LIFT		1pc		P-UB-10	1-1/2	3	JIC-G109452	29.65
3-PT HITCH PITCH		1pc		P-UB-10	1-1/4	2-1/2	JIC-G109476	31.93
3-PT HITCH TILT		1pc		P-UB-10	1-1/4	2-1/2	JIC-G109475	33.21
BACKHOE BUCKET		1pc		P-UB-10	2	3-1/4	JIC-G109465	51.98
		1pc		P-UB-10	2-1/2	3-1/2	JIC-G109504	43.39
BACKHOE DIPPER		1pc		P-UB-10	2	3-1/2	JIC-G109453	43.95
BACKHOE DIPPER EXT		1pc		P-UB-10	1-1/2	3	JIC-G109452	29.65
BACKHOE STABILIZER		1pc		P-UB-10	1-3/4	3-1/2	JIC-G109471	42.84
		1pc		P-UB-10	1-3/4	3	JIC-1543262C1	40.59
BACKHOE SWING		1pc		P-UB-10	1-1/2	3-1/2	JIC-G109472	40.50
LOADER LIFT		1pc		P-UB-10	1-1/2	2-1/2	JIC-1543253C1	43.06
LOADER TILT		1pc		P-UB-10	1-1/2	2-1/2	JIC-1543253C1	43.06
STEERING		1pc	ALL	I-U-10	3/4	1-1/2	JIC-D148100	22.76
<b>MODEL 480E, 480E LL</b>								
3-PT HITCH LIFT		1pc		P-UB-10	1-1/2	3	JIC-G109452	29.65
3-PT HITCH PITCH		1pc		P-UB-10	1-1/4	2-1/2	JIC-G109476	31.93
3-PT HITCH TILT		1pc		P-UB-10	1-1/4	2-1/2	JIC-G109475	33.21
BACKHOE BUCKET		1pc		P-UB-10	2	3-1/4	JIC-G109465	51.98
BACKHOE DIPPER		1pc		P-UB-10	2	3-1/2	JIC-G109453	43.95
BACKHOE DIPPER EXT		1pc		P-UB-10	1-1/2	3	JIC-G109452	29.65
BACKHOE STABILIZER		1pc		P-UB-10	1-3/4	3-1/2	JIC-G109471	42.84
BACKHOE SWING				P-UB-10	1-1/2	3-1/2	JIC-G109472	40.50
LOADER LIFT		1pc		P-UB-10	1-1/2	2-1/2	JIC-1543253C1	43.06

CASE



# CASE

Replacement Kits For

<b>Backhoe Loaders</b>								
APPLICATION	CYL #	Piston	SERIAL #	CODE	ROD	BORE	KIT #	List \$
<b>MODEL 480E, 480E LL</b>								
LOADER TILT		1pc		P-UB-10	1-1/2	2-1/2	JIC-1543253C1	43.06
STEERING		1pc	ALL	I-U-10	3/4	1-1/2	JIC-D148100	22.76
<b>MODEL 480F, 480F LL</b>								
3-PT HITCH LIFT	G101188	1pc		P-UB-10	1-1/4	2-1/2	JIC-1543250C1	36.71
	G101189	1pc		P-UB-10	1-1/2	3	JIC-1543252C1	42.22
3-PT HITCH PITCH	1976884C1	1pc		P-UB-10	1-1/4	2-1/2	JIC-1543249C1	46.16
BACKHOE BOOM	G102835	1pc		P-UB-10	1-3/4	4	JIC-1543264C1	51.14
BACKHOE BUCKET	G109342	1pc		P-UB-10	2-1/2	3-1/2	JIC-1543294C1	46.24
BACKHOE STAB. 480F	1340827C1	1pc		P-UB-10	1-3/4	3-1/2	JIC-1543266C1	50.06
BACKHOE SWING	G110395	1pc		P-UB-10	1-1/2	3-1/2	JIC-1543254C1	46.23
BUCKET 480F ONLY	G103503	1pc		P-UB-10	2	3-1/4	JIC-1543268C1	54.82
DIPPER (12ft)	G104844	1pc		P-UB-10	2	3-1/2	JIC-1543274C1	65.64
DIPPER (14ft)	1980159C1	1pc		P-UB-10	2	3-3/4	JIC-1980181C2	66.95
DIPPER EXT. 480F only	G101203	1pc		P-UB-10	1-1/2	3	JIC-1543252C1	42.22
LOADER BUCKET	G101186	1pc		P-UB-10	1-1/2	2-1/2	JIC-1543253C1	43.06
LOADER CLAM	1346189C1	1pc		P-UB-10	1-3/4	3	JIC-1543267C1	49.14
	G101190	1pc		P-UB-10	1-3/4	3	JIC-1543262C1	40.59
LOADER LIFT	1340792C1	1pc		P-UB-10	1-3/4	3	JIC-1543267C1	49.14
<b>MODEL 530 with Backhoe Models 31, 32, 32S</b>								
BACKHOE BOOM		2pc		P-U-9	2	4	JIC-G32616	49.91
				I-U-1	2		JIC-D42876	19.32
				N-N-9		4	JIC-G33239	25.19
BACKHOE BUCKET		2pc		P-U-9	1-3/4	3-1/2	JIC-G105518	44.55
				P-U-1	1-3/4		JIC-D42873	21.01
				N-N-9		3-1/2	JIC-G33237	23.09
BACKHOE DIPPER		2pc		P-UB-9	2	4	JIC-G105526	54.90
				I-U-1	2		JIC-D42876	19.32
				N-N-9		4	JIC-G33239	25.19
BACKHOE STABILIZER		2pc		P-U-9	1-3/4	3-1/2	JIC-G105518	44.55
				P-UB-9	1-3/4	3-1/2	JIC-G105529	41.78
				P-U-1	1-3/4		JIC-D42873	21.01
				N-N-9		3-1/2	JIC-G33237	23.09
BACKHOE SWING		2pc		P-U-9	1-3/4	4	JIC-G32617	51.99
				P-U-1	1-3/4		JIC-D42875	16.26
				N-N-9		4	JIC-G33239	25.19
LOADER HYDRA-LEVELING		2pc		P-U-1	1-3/4		JIC-D42872	15.33
				N-N-9		3	JIC-G33151	20.85
LOADER LIFT		2pc		P-U-1	1-1/2		JIC-D42869	20.62
				P-U-1	1-1/2		JIC-D42870	20.47
				N-N-9		2-1/2	JIC-G33193	20.35
				N-N-9		3	JIC-G33151	20.85
LOADER TILT		2pc		P-U-1	1-1/2		JIC-D42869	20.62
				P-U-1	1-1/4		JIC-D42867	19.12
				N-N-9		2-1/2	JIC-G33193	20.35
<b>MODEL 580 Super E</b>								
3-PT HITCH LIFT		1pc		P-UB-10	1-1/2	3	JIC-G109452	29.65
3-PT HITCH PITCH		1pc		P-UB-10	1-1/4	2-1/2	JIC-G109476	31.93
3-PT HITCH TILT		1pc		P-UB-10	1-1/4	2-1/2	JIC-G109475	33.21
BACKHOE BOOM		1pc		P-UB-10	1-3/4	3-1/4	JIC-1543265C1	50.29
BACKHOE BUCKET		1pc		P-UB-10	2-1/2	3-1/2	JIC-G109504	43.39
		1pc		P-UB-10	2-1/2	4	JIC-G109424	51.32
BACKHOE DIPPER		1pc		P-UB-10	2	4	JIC-1543273C1	64.28
BACKHOE DIPPER EXT		1pc		P-UB-10	1-1/2	3	JIC-G109452	29.65
BACKHOE STABILIZER		1pc		P-UB-10	2	4	JIC-1543273C1	64.28
BACKHOE SWING		1pc		P-UB-10	2	4	JIC-1543273C1	64.28



# CASE

Replacement Kits For

Backhoe Loaders								
APPLICATION	CYL #	Piston	SERIAL #	CODE	ROD	BORE	KIT #	List \$
<b>MODEL 580 Super E</b>								
LOADER CLAM		1pc		P-UB-10	1-3/4	3	JIC-1543262C1	40.59
LOADER LIFT		1pc		P-UB-10	1-3/4	3	JIC-1543262C1	40.59
LOADER TILT		1pc		P-UB-10	1-1/2	2-1/2	JIC-1543253C1	43.06
STEERING		1pc		I-U-10	3/4	1-1/2	JIC-D148100	22.76
<b>MODEL 580 Super K</b>								
BACKHOE BOOM		1pc		P-UB-10	2-1/4	5	JIC-G110583	133.55
BACKHOE BUCKET		1pc		P-UB-10	2-1/2	3-1/2	JIC-G110046	43.01
BACKHOE DIPPER		1pc		P-UB-10	2-1/2	5	JIC-G110582	52.08
BACKHOE DIPPER EXT		1pc		P-UB-10	1-3/4	3	JIC-G110049	38.47
BACKHOE STABILIZER		1pc		P-UB-10	2	4-1/4	JIC-1543275C1	64.70
BACKHOE SWING		1pc		P-UB-10	1-3/4	3-1/2	JIC-G110621	40.07
LOADER CLAM		1pc		P-UB-10	1-3/4	3	JIC-1543262C1	40.59
LOADER LIFT		1pc		P-UB-10	1-3/4	3-1/2	JIC-G110621	40.07
LOADER TILT		1pc		P-UB-10	1-1/2	3	JIC-G110050	33.95
SIDE SHIFT SWING		1pc		P-UB-10	2-1/4	4-1/2	JIC-1543279C1	56.53
<b>MODEL 580 Super L</b>								
BACKHOE BOOM	144200A1	1pc		P-UB-10	2-1/4	5	JIC-1542919C2	135.72
BACKHOE BUCKET	110290A1	1pc		P-UB-10	2-1/2	3-1/2	JIC-1542923C2	63.46
	235916A1	1pc		P-UB-10	2-1/2	3-1/2	JIC-1542923C2	63.46
BACKHOE DIPPER	126151A1	1pc		P-UB-10	2-1/2	5	JIC-1542915C2	59.99
	183795A1	1pc		P-UB-10	2-1/2	5	JIC-1542915C2	59.99
	183795A2	1pc		P-UB-10	2-1/2	5	JIC-1542915C2	59.99
BACKHOE DIPPER EXT	1340969C2	1pc		P-UB-10	1-3/4	3	JIC-1543267C1	49.14
BACKHOE STABILIZER	143695A1	1pc		P-UB-10	2	4-1/4	JIC-1543275C1	64.70
	143697A1	1pc		P-UB-10	2	4-1/4	JIC-1543275C1	64.70
	199720A1	1pc		P-UB-10	2	4-1/4	JIC-1543275C1	64.70
	199721A1	1pc		P-UB-10	2	4-1/4	JIC-1543275C1	64.70
BACKHOE SWING	139808A1	1pc		P-UB-10	2	4	JIC-122535A1	99.07
LOADER BUCKET	113133A2	1pc		P-UB-10	1-1/2	3	JIC-1543256C1	39.76
LOADER CLAM	1346189C1	1pc		P-UB-10	1-3/4	3	JIC-1543267C1	49.14
	1346190C1	1pc		P-UB-10	1-3/4	3	JIC-1543267C1	49.14
LOADER LIFT	112366A2	1pc		P-UB-10	1-3/4	3-1/4	JIC-1543260C1	50.29
<b>MODEL 580 Super L Construction King</b>								
BACKHOE BOOM	144200A1			P-UB-10	2-1/4	5	JIC-1542919C2	135.72
BACKHOE BUCKET	110290A1			P-UB-10	2-1/2	3-1/2	JIC-1542923C2	63.46
	235916A1			P-UB-10	2-1/2	3-1/2	JIC-1542923C2	63.46
BACKHOE DIPPER	126151A1			P-UB-10	2-1/2	5	JIC-1542915C2	59.99
	183795A1			P-UB-10	2-1/2	5	JIC-1542915C2	59.99
BACKHOE DIPPER EXT	1340969C2			P-UB-10	1-3/4	3	JIC-1543267C1	49.14
BACKHOE SWING	139808A1			P-UB-10	2	4	JIC-122535A1	99.07
	139808A2			P-UB-10	2	4	JIC-122535A1	99.07
LOADER BUCKET	113133A2			P-UB-10	1-1/2	3	JIC-1543256C1	39.76
LOADER CLAM - LH	1346189C1			P-UB-10	1-3/4	3	JIC-1543267C1	49.14
LOADER CLAM - RH	1346190C1			P-UB-10	1-3/4	3	JIC-1543267C1	49.14
LOADER LIFT	112366A2			P-UB-10	1-3/4	3-1/4	JIC-1543260C1	50.29
STABILIZER - LH	143697A1			P-UB-10	2	4-1/4	JIC-1543275C1	64.70
	199721A1			P-UB-10	2	4-1/4	JIC-1543275C1	64.70
STABILIZER - RH	143695A1			P-UB-10	2	4-1/4	JIC-1543275C1	64.70
	199720A1			P-UB-10	2	4-1/4	JIC-1543275C1	64.70
<b>MODEL 580 Super M</b>								
BACKHOE BOOM				P-UB-10	2-1/4	5	JIC-1542919C4	148.11
	310844A1			P-UB-10	2-1/4	5	JIC-1542919C4	148.11
	378031A1			P-UB-10	2-1/4	5	JIC-1542919C4	148.11
	87408036			P-UB-10	2-1/4	5	JIC-1542919C4	148.11
BACKHOE BUCKET	235916A1			P-UB-10	2-1/2	3-1/2	JIC-1542923C2	63.46

CASE



# CASE

Replacement Kits For

<b>Backhoe Loaders</b>								
APPLICATION	CYL #	Piston	SERIAL #	CODE	ROD	BORE	KIT #	List \$
<b>MODEL 580 Super M</b>								
BACKHOE DIPPER	183795A3			P-UB-10	2-1/2	5	JIC-1542915C2	59.99
BACKHOE EXTENDABLE DIPPER	1340969C2			P-UB-10	1-3/4	3	JIC-1543267C1	49.14
BACKHOE STABILIZER LH	199721A1			P-UB-10	2	4-1/4	JIC-1543275C1	64.70
BACKHOE STABILIZER RH	199720A1			P-UB-10	2	4-1/4	JIC-1543275C1	64.70
BACKHOE SWING	139808A2			P-UB-10	2	4	JIC-122535A1	99.07
LOADER BUCKET	113133A2			P-UB-10	1-1/2	3	JIC-1543256C1	39.76
LOADER CLAM LH	1346190C1			P-UB-10	1-3/4	3	JIC-1543267C1	49.14
LOADER CLAM RH	1346189C1			N-UB-1	1-3/4		JIC-1542875C1	17.66
LOADER LIFT	384240A1			P-UB-10	1-3/4	3-1/4	JIC-1543260C1	50.29
<b>MODEL 580 Super M SERIES 3</b>								
BACKHOE BOOM	87711763		02/08-	P-UB-10,12	2-1/2	5-1/4	JIC-87418297	180.19
BACKHOE BUCKET	235916A1		02/08-	P-UB-10	2-1/2	3-1/2	JIC-1542923C2	63.46
BACKHOE DIPPER	183795A4		02/08-	P-UB-10	2-1/2	5	JIC-1542915C2	59.99
BACKHOE STABILIZER LH	199721A1		02/08-	P-UB-10	2	4-1/4	JIC-84155085	63.76
BACKHOE STABILIZER RH	199720A1		02/08-	P-UB-10	2	4-1/4	JIC-84155085	63.76
BACKHOE SWING	139808A2		02/08-	P-UB-10	2	4	JIC-122535A1	99.07
	188027A2		02/08-	P-UB-10	2	3-3/4	JIC-191747A1	95.09
LOADER BUCKET	87609669		02/08-	P-UB-10	1-1/2	3	JIC-1543256C1	39.76
LOADER CLAM LH	87454016		02/08-	P-UB-10	1-3/4	3	JIC-1543267C1	49.14
LOADER CLAM RH	87454017		02/08-	P-UB-10	1-3/4	3	JIC-1543267C1	49.14
LOADER LIFT	384240A1		02/08-	P-UB-10	1-3/4	3-1/4	JIC-1543260C1	50.29
<b>MODEL 580 Super M+ SERIES 3</b>								
BACKHOE BOOM	87711763		02/08-	P-UB-10,12	2-1/2	5-1/4	JIC-87418297	180.19
BACKHOE BUCKET	235916A1		02/08-	P-UB-10	2-1/2	3-1/2	JIC-1542923C2	63.46
BACKHOE DIPPER	183795A4		02/08-	P-UB-10	2-1/2	5	JIC-1542915C2	59.99
BACKHOE EXTENDABLE DIPPER	1340969C2		02/08-	P-UB-10	1-3/4	3	JIC-1543267C1	49.14
BACKHOE STABILIZER LH	177257A1		02/08-	P-UB-10	2-1/4	5	JIC-84154317	64.79
BACKHOE STABILIZER RH	177256A1		02/08-	P-UB-10	2-1/4	5	JIC-84154317	64.79
BACKHOE SWING	139808A2		02/08-	P-UB-10	2	4	JIC-122535A1	99.07
LOADER BUCKET	87609669		02/08-	P-UB-10	1-1/2	3	JIC-1543256C1	39.76
LOADER CLAM LH	87454016		02/08-	P-UB-10	1-3/4	3	JIC-1543267C1	49.14
LOADER CLAM RH	87454017		02/08-	P-UB-10	1-3/4	3	JIC-1543267C1	49.14
LOADER LIFT	384240A1		02/08-	P-UB-10	1-3/4	3-1/4	JIC-1543260C1	50.29
<b>MODEL 580 with Backhoe Models 33, 33S</b>								
3-PT HITCH LIFT		2pc		P-U-9	1-1/2	2-1/2	JIC-G32294	35.93
3-PT HITCH PITCH		2pc		P-U-9	1-1/4	2-1/2	JIC-G32295	45.16
		1pc		P-U-10	1-1/4	2-1/2	JIC-G105507	26.36
3-PT HITCH TILT		2pc		P-UB-9	1-1/2	3	JIC-G105512	52.15
BACKHOE BOOM		1pc		P-UB-9	2-1/4	4-1/2	JIC-G105520	88.28
		2pc		P-U-9	2	4	JIC-G32299	51.90
		2pc		P-UB-9	2	4	JIC-G105517	54.98
				I-U-1	2		JIC-D42876	19.32
				P-U-1	2-1/4		JIC-D42878	18.66
		2pc		N-N-9		4	JIC-G33239	25.19
		2pc		N-N-9		4-1/2	JIC-DTVS4.5P	51.78
		2pc		P-UB-9	2	3-1/2	JIC-G105527	52.45
BACKHOE BUCKET		2pc		P-U-9	2	3-1/2	JIC-G32293	40.26
				I-U-1	2		JIC-D42874	16.35
		2pc		P-U-1	1-3/4		JIC-D42873	21.01
				P-U-1	2-1/4		JIC-D42878	18.66
		2pc		N-N-9		3-1/2	JIC-G33237	23.09
BACKHOE DIPPER		2pc		P-U-9	2	4	JIC-G32299	51.90
		2pc		P-UB-9	2	4	JIC-G105517	54.98
				I-U-1	2		JIC-D42876	19.32

CASE





# CASE

Replacement Kits For

<b>Backhoe Loaders</b>								
APPLICATION	CYL #	Piston	SERIAL #	CODE	ROD	BORE	KIT #	List \$
<b>MODEL 580 with Backhoe Models 33, 33S</b>								
BACKHOE DIPPER		2pc		N-N-9		4	JIC-G33239	25.19
BACKHOE DIPPER EXT		2pc		P-UB-9	1-1/2	3	JIC-G105512	52.15
		2pc		P-UB-9	1-3/4	3-1/2	JIC-G105529	41.78
				P-U-1	1-3/4		JIC-D42873	21.01
		2pc		N-N-9		3-1/2	JIC-G33237	23.09
BACKHOE STABILIZER		2pc		P-U-9	1-3/4	3-1/2	JIC-G105518	44.55
		2pc		P-UB-9	1-3/4	3-1/2	JIC-G105529	41.78
				P-U-1	1-3/4		JIC-D42873	21.01
		2pc		N-N-9		3-1/2	JIC-G33237	23.09
BACKHOE SWING		2pc		P-UB-9	1-3/4	4	JIC-G105519	49.76
				P-U-1	1-3/4		JIC-D42875	16.26
		2pc		N-N-9		4	JIC-G33239	25.19
LOADER CLAM		2pc		P-UB-9	1-3/4	3	JIC-G105524	57.47
LOADER GRAPPLE		2pc		P-U-9	1-1/2	2-1/2	JIC-G32294	35.93
				P-U-1	1-1/2		JIC-D42869	20.62
		2pc		N-N-9		2-1/2	JIC-G33193	20.35
LOADER HYDRA-LEVELING		2pc		P-UB-9	1-3/4	3	JIC-G105524	57.47
				P-U-1	1-3/4		JIC-D42872	15.33
		2pc		N-N-9		3	JIC-G33151	20.85
LOADER LIFT		2pc		P-UB-9	1-1/2	3	JIC-G105512	52.15
				P-U-1	1-1/2		JIC-D42870	20.47
		2pc		N-N-9		3	JIC-G33151	20.85
LOADER TILT		2pc		P-U-9	1-1/2	2-1/2	JIC-G32294	35.93
				P-U-1	1-1/2		JIC-D42869	20.62
		2pc		N-N-9		2-1/2	JIC-G33193	20.35
<b>MODEL 580B with Backhoe Model 35</b>								
3-PT HITCH LIFT		2pc		P-UB-9	1-1/2	3	JIC-G105512	52.15
		1pc		P-UB-10	1-1/2	3	JIC-G105548	39.05
3-PT HITCH PITCH		1pc		P-U-10	1-1/4	2-1/2	JIC-G105507	26.36
		2pc		P-U-9	1-1/4	2-1/2	JIC-G32295	45.16
3-PT HITCH TILT		2pc		P-U-9	1-1/4	2-1/2	JIC-G32295	45.16
		1pc		P-UB-10	1-1/4	2-1/2	JIC-G105551	33.21
BACKHOE BOOM		2pc		P-UB-9	1-3/4	3-1/4	JIC-G105528	47.83
		1pc		P-UB-10	1-3/4	3-1/4	JIC-G105547	44.90
BACKHOE BUCKET		1pc		P-UB-10	2	3-1/2	JIC-G105546	46.94
		2pc		P-UB-9	2	3-1/2	JIC-G105527	52.45
BACKHOE DIPPER		1pc		P-UB-10	2	4	JIC-1543273C1	64.28
		2pc		P-UB-9	2	4	JIC-G105517	54.98
BACKHOE DIPPER EXT		2pc		P-UB-9	1-1/2	3	JIC-G105512	52.15
		1pc		P-UB-10	1-1/2	3	JIC-G105548	39.05
BACKHOE STABILIZER		1pc		P-UB-10	2	4	JIC-1543273C1	64.28
		2pc		P-UB-9	2	3-1/2	JIC-G105527	52.45
		2pc		P-UB-9	2	4	JIC-G105517	54.98
		2pc		P-UB-9	1-3/4	3-1/2	JIC-G105529	41.78
BACKHOE SWING		2pc		P-UB-9	2	4	JIC-G105517	54.98
		1pc		P-UB-10	2	4	JIC-1543273C1	64.28
LOADER CLAM		1pc		P-UB-10	1-3/4	3	JIC-G105549	49.69
		2pc		P-UB-9	1-3/4	3	JIC-G105524	57.47
LOADER HYDRA-LEVELING		2pc		P-UB-9	1-3/4	3	JIC-G105524	57.47
		1pc		P-UB-10	1-3/4	3	JIC-G105549	49.69
LOADER LIFT		2pc		P-UB-9	1-1/2	3	JIC-G105512	52.15
		1pc		P-UB-10	1-1/2	3	JIC-G105548	39.05
LOADER TILT		1pc		P-UB-10	1-1/2	2-1/2	JIC-G105550	29.30
		2pc		P-U-9	1-1/2	2-1/2	JIC-G32294	35.93
LOGGING FORK GRAPPLE		2pc		P-U-9	1-1/2	2-1/2	JIC-G32294	35.93

CASE



# CASE

Replacement Kits For

<b>Backhoe Loaders</b>								
APPLICATION	CYL #	Piston	SERIAL #	CODE	ROD	BORE	KIT #	List \$
<b>MODEL 580B with Backhoe Model 35</b>								
LOGGING FORK GRAPPLE		1pc		P-UB-10	1-1/2	2-1/2	JIC-G105550	29.30
STEERING		1pc		I-O-3	3/4	1-1/2	JIC-A44644	10.38
<b>MODEL 580C</b>								
3-PT HITCH LIFT		1pc		P-UB-10	1-1/2	3	JIC-G109452	29.65
		2pc		P-UB-9	1-1/2	3	JIC-G105512	52.15
3-PT HITCH PITCH		1pc		P-UB-10	1-1/4	2-1/2	JIC-G109476	31.93
3-PT HITCH TILT		2pc		P-U-9	1-1/4	2-1/2	JIC-G32295	45.16
		1pc		P-UB-10	1-1/4	2-1/2	JIC-G109475	33.21
BACKHOE BOOM		2pc		P-UB-9	1-3/4	3-1/4	JIC-G105528	47.83
		1pc		P-UB-10	1-3/4	3-1/4	JIC-1543265C1	50.29
BACKHOE BUCKET		2pc		P-UB-9	2	3-1/2	JIC-G109454	34.85
		1pc		P-UB-10	2	3-1/2	JIC-G109453	43.95
BACKHOE DIPPER		1pc		P-UB-10	2	4	JIC-1543273C1	64.28
		2pc		P-UB-9	2	4	JIC-G109421	45.05
BACKHOE DIPPER EXT		2pc		P-UB-9	1-1/2	3	JIC-G105512	52.15
		1pc		P-UB-10	1-1/2	3	JIC-G109452	29.65
BACKHOE STABILIZER		1pc		P-UB-10	2	4	JIC-1543273C1	64.28
		2pc		P-UB-9	2	4	JIC-G109421	45.05
BACKHOE SWING		2pc		P-UB-9	2	4	JIC-G109421	45.05
		1pc		P-UB-10	2	4	JIC-1543273C1	64.28
LOADER CLAM		2pc		P-UB-9	1-3/4	3	JIC-G109462	36.31
		1pc		P-UB-10	1-3/4	3	JIC-1543262C1	40.59
LOADER GRAPPLE		1pc		P-UB-10	1-1/2	2-1/2	JIC-1543253C1	43.06
		2pc		P-UB-9	1-1/2	2-1/2	JIC-G109484	41.75
LOADER LIFT		1pc		P-UB-10	1-3/4	3	JIC-1543262C1	40.59
		2pc		P-UB-9	1-3/4	3	JIC-G109462	36.31
LOADER TILT		1pc		P-UB-10	1-1/2	2-1/2	JIC-1543253C1	43.06
		2pc		P-UB-9	1-1/2	2-1/2	JIC-G109484	41.75
STEERING		1pc	-8983287	I-O-3	3/4	1-1/2	JIC-A44644	10.38
		1pc	8983288-	I-U-10	3/4	1-1/2	JIC-D148100	22.76
<b>MODEL 580C Construction King</b>								
3-PT HITCH LIFT	G101189	1pc		P-UB-10	1-1/2	3	JIC-G105548	39.05
	G33456	2pc		P-UB-9	1-1/2	3	JIC-G105512	52.15
3-PT HITCH PITCH	G33128			P-U-10	1-1/4	2-1/2	JIC-G105507	26.36
3-PT HITCH TILT	G101188	1pc		P-UB-10	1-1/4	2-1/2	JIC-G105551	33.21
	G33351	2pc		P-U-9	1-1/4	2-1/2	JIC-G32295	45.16
BACKHOE BOOM	G101177	1pc		P-UB-10	1-3/4	3-1/4	JIC-G105547	44.90
	G33881	2pc		P-UB-9	1-3/4	3-1/4	JIC-G105528	47.83
BACKHOE BUCKET	G101176			P-UB-10	2	3-1/2	JIC-G105546	46.94
	G33196	2pc		P-UB-9	2	3-1/2	JIC-G105527	52.45
BACKHOE DIPPER	G101175	1pc		P-UB-10	2	4	JIC-G105545	53.06
	G32079	2pc		P-U-9	2	4	JIC-G34594	53.60
BACKHOE DIPPER EXT	G101183	1pc		P-UB-10	1-1/2	3	JIC-G105548	39.05
	G33142	2pc		P-UB-9	1-1/2	3	JIC-G105512	52.15
BACKHOE STABILIZER LH	G101181	1pc		P-UB-10	2	4	JIC-G105545	53.06
	G34471	2pc		P-U-9	2	4	JIC-G34594	53.60
BACKHOE STABILIZER RH	G101180	1pc		P-UB-10	2	4	JIC-G105545	53.06
	G34470	2pc		P-U-9	2	4	JIC-G34594	53.60
BACKHOE SWING	G101182	1pc		P-UB-10	2	4	JIC-G105545	53.06
	G102525	1pc	5411088-	P-UB-10	2	4	JIC-G105545	53.06
	G34881	2pc		P-U-9	2	4	JIC-G34594	53.60
LOADER BUCKET LH	G33421	2pc		P-U-9	1-1/2	2-1/2	JIC-G32294	35.93
LOADER BUCKET RH	G33420	2pc		P-U-9	1-1/2	2-1/2	JIC-G32294	35.93
LOADER BUCKET TILT LH	G101187	1pc		P-UB-10	1-1/2	2-1/2	JIC-G105550	29.30
LOADER BUCKET TILT RH	G101186	1pc		P-UB-10	1-1/2	2-1/2	JIC-G105550	29.30



# CASE

Replacement Kits For

<b>Backhoe Loaders</b>								
APPLICATION	CYL #	Piston	SERIAL #	CODE	ROD	BORE	KIT #	List \$
<b>MODEL 580C Construction King</b>								
LOADER CLAM LH	G101191	1pc		P-UB-10	1-3/4	3	JIC-G105549	49.69
	G33799	2pc		P-UB-9	1-3/4	3	JIC-G105524	57.47
LOADER CLAM RH	G101190	1pc		P-UB-10	1-3/4	3	JIC-G105549	49.69
	G33798	2pc		P-UB-9	1-3/4	3	JIC-G105524	57.47
LOADER GRAPPLE	G101251	1pc		P-UB-10	1-1/2	2-1/2	JIC-G105550	29.30
	G34293	2pc		P-U-9	1-1/2	2-1/2	JIC-G32294	35.93
LOADER LIFT	G101184	1pc		P-UB-10	1-3/4	3	JIC-G105549	49.69
LOADER LIFT LH	G100414	2pc		P-UB-9	1-3/4	3	JIC-G105524	57.47
LOADER LIFT RH	G100415	2pc		P-UB-9	1-3/4	3	JIC-G105524	57.47
<b>MODEL 580D, 580 Super D</b>								
3-PT HITCH LIFT		1pc		P-UB-10	1-1/2	3	JIC-G109452	29.65
3-PT HITCH PITCH		1pc		P-UB-10	1-1/4	2-1/2	JIC-G109476	31.93
3-PT HITCH TILT		1pc		P-UB-10	1-1/4	2-1/2	JIC-G109475	33.21
BACKHOE BOOM		1pc		P-UB-10	1-3/4	3-1/4	JIC-1543265C1	50.29
BACKHOE BUCKET		1pc		P-UB-10	2-1/2	3-1/2	JIC-G109504	43.39
		1pc		P-UB-10	2	3-1/2	JIC-G109453	43.95
BACKHOE DIPPER		1pc		P-UB-10	2	4	JIC-1543273C1	64.28
		1pc		P-UB-10	2-1/2	4	JIC-G109424	51.32
BACKHOE DIPPER EXT		1pc		P-UB-10	1-1/2	3	JIC-G109452	29.65
BACKHOE STABILIZER		1pc		P-UB-10	2	4	JIC-1543273C1	64.28
BACKHOE SWING		1pc		P-UB-10	2	4	JIC-1543273C1	64.28
LOADER CLAM		1pc		P-UB-10	1-3/4	3	JIC-1543262C1	40.59
LOADER LIFT		1pc		P-UB-10	1-3/4	3	JIC-1543262C1	40.59
LOADER TILT		1pc		P-UB-10	1-1/2	2-1/2	JIC-1543253C1	43.06
STEERING		1pc		I-U-10	3/4	1-1/2	JIC-D148100	22.76
<b>MODEL 580F</b>								
BACKHOE BOOM		2pc		P-UB-9	1-3/4	3-1/4	JIC-G105528	47.83
		1pc		P-UB-10	1-3/4	3-1/4	JIC-G105547	44.90
BACKHOE BUCKET		1pc		P-UB-10	2	3-1/2	JIC-G105546	46.94
		2pc		P-UB-9	2	3-1/2	JIC-G105527	52.45
BACKHOE DIPPER		1pc		P-UB-10	2	4	JIC-1543273C1	64.28
		2pc		P-UB-9	2	4	JIC-G105517	54.98
BACKHOE STABILIZER		2pc	-3.775.176	P-UB-9	2	4	JIC-G105517	54.98
		1pc	3.775.177-	P-UB-10	2	4	JIC-1543273C1	64.28
		2pc	-3.785.895	P-UB-9	1-3/4	3	JIC-G105524	57.47
		1pc	3.785.896-	P-UB-10	1-3/4	3	JIC-G105549	49.69
BACKHOE SWING		2pc	-3.775.161	P-UB-9	2	4	JIC-G105517	54.98
		1pc	3.775.162-	P-UB-10	2	4	JIC-1543273C1	64.28
		2pc	-3.785.922	P-U-9	1-3/4	4	JIC-G34626	53.90
		1pc	3.785.923-3.787.235	P-UB-10	1-3/4	4	JIC-G105552	46.78
BOOM EXTENSION		2pc		P-UB-9	1-1/2	3	JIC-G105512	52.15
		1pc		P-UB-10	1-1/2	3	JIC-G105548	39.05
LOADER CLAM		1pc		P-UB-10	1-3/4	3	JIC-G105549	49.69
		2pc		P-UB-9	1-3/4	3	JIC-G105524	57.47
LOADER LIFT		1pc		P-UB-10	2	3-1/4	JIC-G105553	49.22
LOADER TILT		2pc		P-U-9	1-1/2	2-1/2	JIC-G32294	35.93
		1pc		P-UB-10	1-1/2	2-1/2	JIC-G105550	29.30
STEERING		1pc	3.736.937-	I-U-10	3/4	1-1/2	JIC-D148100	22.76
<b>MODEL 580K</b>								
3-PT HITCH LIFT & TILT		1pc		P-UB-10	1-1/4	2-3/4	JIC-G110047	40.79
		1pc		P-UB-10	1-1/4	3	JIC-G110048	30.54
BACKHOE BOOM		1pc		P-UB-10	2-1/4	5	JIC-G110583	133.55
BACKHOE BUCKET		1pc		P-UB-10	2-1/2	3-1/2	JIC-G110046	43.01
BACKHOE DIPPER		1pc		P-UB-10	2-1/2	5	JIC-1542915C2	59.99
BACKHOE DIPPER EXT		1pc		P-UB-10	1-3/4	3	JIC-G110049	38.47

CASE



# CASE

Replacement Kits For

Backhoe Loaders								
APPLICATION	CYL #	Piston	SERIAL #	CODE	ROD	BORE	KIT #	List \$
<b>MODEL 580K</b>								
BACKHOE STABILIZER		1pc		P-UB-10	2	4-1/4	JIC-1543275C1	64.70
BACKHOE SWING		1pc		P-UB-10	1-3/4	3-1/2	JIC-G110621	40.07
		1pc		P-UB-10	1-3/4	3-1/4	JIC-G110053	35.29
LOADER CLAM		1pc		P-UB-10	1-3/4	3	JIC-1543262C1	40.59
LOADER LIFT		1pc		P-UB-10	1-3/4	3-1/4	JIC-G110053	35.29
LOADER TILT		1pc		P-UB-10	1-1/2	3	JIC-G110050	33.95
SIDE SHIFT STABILIZER		1pc		P-UB-10	1-3/4	3	JIC-1543262C1	40.59
SIDE SHIFT SWING		1pc		P-UB-10	2	4	JIC-1543269C1	61.25
STEERING		1pc		P-U-10	1-1/2	2-3/4	JIC-G110045	62.71
<b>MODEL 580L</b>								
3-PT HITCH LIFT	137512A1	1pc		P-UB-10	1-1/2	3	JIC-1543256C1	39.76
	137912A1	1pc		P-U-10	1-1/4	2-1/2	JIC-183286A1	45.79
	196832A1	1pc		P-UB-10	1-1/2	3	JIC-1543256C1	39.76
3-PT HITCH PITCH	138235A1	1pc		P-U-10	1-1/4	2-1/2	JIC-183286A1	45.79
BACKHOE BOOM	182106A1	1pc		P-UB-10	2-1/4	4-1/2	JIC-182218A1	89.50
BACKHOE BUCKET	128760A1	1pc		P-UB-10	2-1/4	3-1/4	JIC-131750A2	62.16
BACKHOE DIPPER	175774A1	1pc		P-UB-10	2-1/4	4-1/4	JIC-234844A1	92.90
	233114A1	1pc		P-UB-10	2-1/4	4-1/4	JIC-234844A1	92.90
BACKHOE DIPPER EXT	1340970C2	1pc		P-UB-10	1-3/4	3	JIC-1543267C1	49.14
BACKHOE STABILIZER	143574A1	1pc		P-UB-10	2	4	JIC-1543269C1	61.25
	143575A1	1pc		P-UB-10	2	4	JIC-1543269C1	61.25
	195503A1	1pc		P-UB-10	2	4	JIC-1543269C1	61.25
	195504A1	1pc		P-UB-10	2	4	JIC-1543269C1	61.25
BACKHOE SWING	139808A1	1pc		P-UB-10	2	4	JIC-122535A1	99.07
	139808A2	1pc		P-UB-10	2	4	JIC-122535A1	99.07
	188027A1	1pc		P-UB-10	2	3-3/4	JIC-191747A1	95.09
LOADER BUCKET	175238A1	1pc		P-UB-10	1-1/2	2-3/4	JIC-175251A1	97.17
LOADER CLAM	1346189C1	1pc		P-UB-10	1-3/4	3	JIC-1543267C1	49.14
LOADER LIFT	131417A1	1pc		P-UB-10	1-3/4	3	JIC-1543267C1	49.14
<b>MODEL 580M</b>								
BACKHOE BOOM	189653A2		02/08-	P-UB-10	2-1/4	4-1/2	JIC-182218A1	89.50
BACKHOE BUCKET	128760A1		02/08-	P-UB-10	2-1/4	3-1/4	JIC-131750A2	62.16
BACKHOE DIPPER	233114A2		02/08-	P-UB-10	2-1/4	4-1/4	JIC-234844A1	92.90
BACKHOE EXTENDABLE DIPPER	1340969C2		02/08-	P-UB-10	1-3/4	3	JIC-1543267C1	49.14
BACKHOE STABILIZER LH	195503A1		02/08-	P-UB-10	2	4	JIC-1543269C1	61.25
BACKHOE STABILIZER RH	195503A1		02/08-	P-UB-10	2	4	JIC-1543269C1	61.25
BACKHOE SWING	188027A2		02/08-	P-UB-10	2	3-3/4	JIC-191747A1	95.09
LOADER BUCKET	113133A2			P-UB-10	1-1/2	3	JIC-1543256C1	39.76
	87609669		02/08-	P-UB-10	1-1/2	3	JIC-1543256C1	39.76
LOADER CLAM	1346189C1			P-UB-10	1-3/4	3	JIC-1543267C1	49.14
LOADER CLAM LH	87454016		02/08-	P-UB-10	1-3/4	3	JIC-1543267C1	49.14
LOADER CLAM RH	87454017		02/08-	P-UB-10	1-3/4	3	JIC-1543267C1	49.14
LOADER LIFT	384240A1		02/08-	P-UB-10	1-3/4	3-1/4	JIC-1543260C1	50.29
<b>MODEL 590</b>								
BACKHOE BOOM	1980395C5	1pc		P-UB-10	2-1/2	5-1/2	JIC-1980412C2	193.37
	1980395C6	1pc		P-UB-10	2-1/2	5-1/2	JIC-1980412C2	193.37
BACKHOE BUCKET	1986902C1	1pc		P-UB-10	2-1/2	3-1/2	JIC-1542923C2	63.46
	1986902C2	1pc		P-UB-10	2-1/2	3-1/2	JIC-1542923C2	63.46
BACKHOE DIPPER	1994520C1	1pc		P-UB-10	2-3/4	5-1/2	JIC-1994527C2	176.05
	1994520C2	1pc		P-UB-10	2-3/4	5-1/2	JIC-1994527C2	176.05
BACKHOE DIPPER EXT	1340853C2	1pc		P-UB-10	1-3/4	3	JIC-1543267C1	49.14
BACKHOE STABILIZER	110885A1	1pc		P-UB-10	2-1/4	5	JIC-1543289C2	77.40
	110886A1	1pc		P-UB-10	2-1/4	5	JIC-1543289C2	77.40
	1986810C1	1pc		P-UB-10	2-1/4	5	JIC-1543289C2	77.40
	1986811C1	1pc		P-UB-10	2-1/4	5	JIC-1543289C2	77.40



# CASE

Replacement Kits For

Backhoe Loaders								
APPLICATION	CYL #	Piston	SERIAL #	CODE	ROD	BORE	KIT #	List \$
<b>MODEL 590</b>								
BACKHOE SWING	1343584C1	1pc		P-UB-10	2	3-3/4	JIC-1980181C2	66.95
	1343584C2	1pc		P-UB-10	2	3-3/4	JIC-1980181C2	66.95
LOADER BUCKET	110306A1	1pc		P-UB-10	1-1/2	3	JIC-1543256C1	39.76
	110309A1	1pc		P-UB-10	1-1/2	3	JIC-1543256C1	39.76
	G108486	1pc		P-UB-10	1-1/2	3	JIC-1543256C1	39.76
	G108487	1pc		P-UB-10	1-1/2	3	JIC-1543256C1	39.76
LOADER CLAM	1346189C1	1pc		P-UB-10	1-3/4	3	JIC-1543267C1	49.14
	1346190C1	1pc		P-UB-10	1-3/4	3	JIC-1543267C1	49.14
LOADER LIFT	110875A1	1pc		P-UB-10	1-3/4	3-1/2	JIC-1543266C1	50.06
	1542743C1	1pc		P-UB-10	1-3/4	3-1/2	JIC-1543266C1	50.06
	1980220C2	1pc		P-UB-10	1-3/4	3-1/2	JIC-1543266C1	50.06
<b>MODEL 590 Super L</b>								
BACKHOE BOOM	175785A1	1pc		P-UB-10	2-1/2	5-1/2	JIC-1980412C2	193.37
BACKHOE BUCKET	1986902C2	1pc		P-UB-10	2-1/2	3-1/2	JIC-1542923C2	63.46
	238435A1	1pc		P-UB-10	2-1/2	3-1/2	JIC-1542923C2	63.46
BACKHOE DIPPER	140965A1	1pc		P-UB-10	2-3/4	5-1/2	JIC-179011A1	139.02
BACKHOE DIPPER EXT	1340853C2	1pc		P-UB-10	1-3/4	3	JIC-1543267C1	49.14
BACKHOE STABILIZER	177256A1	1pc		P-UB-10	2-1/4	5	JIC-1543289C2	77.40
	177257A1	1pc		P-UB-10	2-1/4	5	JIC-1543289C2	77.40
BACKHOE SWING	139808A1	1pc		P-UB-10	2	4	JIC-122535A1	99.07
LOADER BUCKET	113133A2	1pc		P-UB-10	1-1/2	3	JIC-1543256C1	39.76
LOADER CLAM	1346189C1	1pc		P-UB-10	1-3/4	3	JIC-1543267C1	49.14
	1346190C1	1pc		P-UB-10	1-3/4	3	JIC-1543267C1	49.14
LOADER LIFT	133936A1	1pc		P-UB-10	1-3/4	3-1/2	JIC-1543266C1	50.06
<b>MODEL 590 Super M</b>								
BACKHOE BOOM	175785A1			P-UB-10	2-1/2	5-1/2	JIC-1980412C2	193.37
BACKHOE BUCKET	296434A1			P-UB-10	2-3/4	3-3/4	JIC-297895A1	69.54
BACKHOE DIPPER	140965A1			P-UB-10	2-3/4	5-1/2	JIC-179011A1	139.02
BACKHOE EXT. DIPPER	1340853C1			P-UB-10	1-3/4	3	JIC-1543267C1	49.14
BACKHOE SWING	139808A2			P-UB-10	2	4	JIC-122535A1	99.07
LOADER BUCKET	255756A1			P-UB-10	1-3/4	3-1/4	JIC-1543260C1	50.29
LOADER CLAM	1346189C1			P-UB-10	1-3/4	3	JIC-1543267C1	49.14
	1346190C1			P-UB-10	1-3/4	3	JIC-1543267C1	49.14
LOADER LIFT	133936A1			P-UB-10	1-3/4	3-1/2	JIC-1543266C1	50.06
STEERING	1986518C2			P-U-10	1-1/2	2-3/4	JIC-G110045	62.71
<b>MODEL 590 Super M SERIES 3</b>								
BACKHOE BOOM	175785A1		02/08-	I-UB-10	2-1/2	5-1/2	JIC-87367429	139.01
BACKHOE BUCKET	296434A1		02/08-	P-UB-10	2-3/4	3-3/4	JIC-297895A1	69.54
BACKHOE DIPPER	1340853C2		02/08-	P-UB-10	1-3/4	3	JIC-1543267C1	49.14
	140965A1		02/08-	P-UB-10,12	2-3/4	5-1/2	JIC-87367212	119.63
BACKHOE STABILIZER LH	177257A1		02/08-	P-UB-10	2-1/4	5	JIC-84154317	64.79
BACKHOE STABILIZER RH	177256A1		02/08-	P-UB-10	2-1/4	5	JIC-84154317	64.79
BACKHOE SWING	139808A2		02/08-	P-UB-10	2	4	JIC-122535A1	99.07
LOADER BUCKET	255756A1		02/08-	P-UB-10	1-3/4	3-1/4	JIC-1543260C1	50.29
LOADER CLAM LH	87454016		02/08-	P-UB-10	1-3/4	3	JIC-1543267C1	49.14
LOADER CLAM RH	87454017		02/08-	P-UB-10	1-3/4	3	JIC-1543267C1	49.14
LOADER LIFT	133936A1		02/08-	P-UB-10	1-3/4	3-1/2	JIC-1543266C1	50.06
<b>MODEL 590SR Super R</b>								
BACKHOE EXTENSION	87412686		1/04-	P-UB-10	2	2-3/4	JIC-87428866	33.79
BOOM	85820245		1/04-	P-UB-10,12	2-1/2	135 mm	JIC-87428634	188.56
	87412698		1/04-	P-UB-10	2-1/2	135 mm	JIC-87428874	154.82
BUCKET	87412691		1/04-	P-UB-10	2-1/2	90 mm	JIC-87428869	60.81
CLAMSHELL	85820005		1/04-	I-U-15	45 mm	80 mm	JIC-85824250	59.87
DIPPER	85820244		1/04-	P-UB-10	63 mm	4-1/2	JIC-85819350	155.44
	87412696		1/04-, After 13 Feb 2008	P-UB-10	2-1/2	4-1/2	JIC-87633295	102.86

CASE



# CASE

Replacement Kits For

Backhoe Loaders								
APPLICATION	CYL #	Piston	SERIAL #	CODE	ROD	BORE	KIT #	List \$
<b>MODEL 590SR Super R</b>								
LOADER LIFT	87429845		1/04-	P-UB-10	2	3-1/2	JIC-87432407	44.04
LOADER TILT	87429582		1/04-	P-UB-10	1-3/4	3-1/4	JIC-87432412	45.78
STABILIZER (SIDESHIFT)	87412685		1/04-	P-UB-10	2	2-3/4	JIC-87428866	33.79
SWING	87424832		1/04-, -N5GH02283	P-UB-10	2	110 mm	JIC-87445307-NP	62.20
	87450927		1/04-, N5GH002284-	P-UB-10	2	110 mm	JIC-87445307-NP	62.20
<b>MODEL 590SR Super R Tier 2</b>								
BACKHOE	87327257		3/05-	P-UB-10	1-3/4	3	JIC-87342131	38.63
BOOM	87412698		3/05-	P-UB-10	2-1/2	135 mm	JIC-87428874	154.82
BUCKET	235916A1		3/05-	P-UB-10	2-1/2	3-1/2	JIC-1542923C2	63.46
CLAMSHELL	87573861		3/05-	I-U-15	45 mm	80 mm	JIC-87573868	59.87
DIPPER	87412696		3/05-, After 13 Feb 2008	P-UB-10	2-1/2	4-1/2	JIC-87633295	102.86
EXTENSION	87412686		3/05-	P-UB-10	2	2-3/4	JIC-87428866	33.79
LOADER LIFT	87429845		3/05-	P-UB-10	2	3-1/2	JIC-87432407	44.04
LOADER TILT	87307299		3/05-	P-UB-10	1-3/4	3-1/4	JIC-87432412	45.78
	87429582		3/05-	P-UB-10	1-3/4	3-1/4	JIC-87432412	45.78
STABILIZER (SIDESHIFT)	87412685		3/05-	P-UB-10	2	2-3/4	JIC-87428866	33.79
	87574187		3/05-	P-UB-10	2	2-3/4	JIC-87428620	36.95
SWING	87450927		3/05-	P-UB-10	2	110 mm	JIC-87428631	70.63
<b>MODEL 590SR Super R Tier 3</b>								
BACKHOE EXTENSION	87327257		2/07-	P-UB-10	1-3/4	3	JIC-87342131	38.63
	87327257		2008-	P-UB-10	1-3/4	3	JIC-87342131	38.63
BOOM	87412698		2/07-	P-UB-10	2-1/2	135 mm	JIC-87428874	154.82
	87412698		2008-	P-UB-10	2-1/2	135 mm	JIC-87428874	154.82
BUCKET	235916A1		2/07-	P-UB-10	2-1/2	3-1/2	JIC-1542923C2	63.46
	235916A1		2008-	P-UB-10	2-1/2	3-1/2	JIC-1542923C2	63.46
CLAMSHELL	87573861		2/07-	I-U-15	45 mm	80 mm	JIC-87573868	59.87
	87573861		2008-	I-U-15	45 mm	80 mm	JIC-87573868	59.87
DIPPER	87412696		2/07-, After 13 Feb 2008	P-UB-10	2-1/2	4-1/2	JIC-87633295	102.86
	87412696		2008-, After 13 Feb 2008	P-UB-10	2-1/2	4-1/2	JIC-87633295	102.86
LOADER LIFT	87429845		2/07-	P-UB-10	2	3-1/2	JIC-87432407	44.04
	87585103		2008-	P-UB-10	2	3-3/4	JIC-87651309	51.72
LOADER TILT	87307299		2/07-	P-UB-10	1-3/4	3-1/4	JIC-87432412	45.78
	87307299		2008-	P-UB-10	1-3/4	3-1/4	JIC-87432412	45.78
STABILIZER (CENTRE PIVOT)	84209919		2008-	P-UB-14	2-1/4	4	JIC-84209920	80.87
STABILIZER (SIDESHIFT)	87574187		2/07-	P-UB-10	2	2-3/4	JIC-87608671	41.48
	87627940		2008-	P-UB-10	2	3	JIC-87653283	33.97
SWING	87450927		2/07-	P-UB-10	2	110 mm	JIC-87428631	70.63
	87450927		2008-	P-UB-10	2	110 mm	JIC-87428631	70.63
<b>MODEL 680</b>								
3-PT HITCH PITCH		1pc	ALL	P-UB-10	1-1/4	2-1/2	JIC-G110055	50.08
BACKHOE BOOM				P-U-1	2-1/4		JIC-D42878	18.66
		2pc		N-N-9		4-1/2	JIC-DTVS4.5P	51.78
BACKHOE BUCKET				I-U-1	2-1/4		JIC-D42877	15.20
		2pc		N-N-9		4	JIC-G33239	25.19
BACKHOE DIPPER				P-U-1	2-1/4		JIC-D42878	18.66
		2pc		N-N-9		4-1/2	JIC-DTVS4.5P	51.78
BACKHOE STABILIZER				P-U-1	1-3/4		JIC-D42873	21.01
		2pc		N-N-9		3-1/2	JIC-G33237	23.09
BACKHOE SWING				P-U-1	1-3/4		JIC-D42875	16.26
		2pc		N-N-9		4	JIC-G33239	25.19
LOADER TILT				P-U-1	1-3/4		JIC-D42873	21.01
		2pc		N-N-9		3-1/2	JIC-G33237	23.09





# CASE

Replacement Kits For

Backhoe Loaders								
APPLICATION	CYL #	Piston	SERIAL #	CODE	ROD	BORE	KIT #	List \$
<b>MODEL 680B</b>								
BACKHOE BOOM		2pc		P-U-9	2-1/4	5	JIC-G32696	75.24
BACKHOE BUCKET		2pc		P-UB-9	2-1/4	4	JIC-G34636	59.90
				I-U-1	2-1/4		JIC-D42877	15.20
		2pc		N-N-9		4	JIC-G33239	25.19
BACKHOE DIPPER		2pc		P-UB-9	2-1/4	4-1/2	JIC-G105520	88.28
				P-U-1	2-1/4		JIC-D42878	18.66
		2pc		N-N-9		4-1/2	JIC-DTVS4.5P	51.78
BACKHOE STABILIZER		2pc		P-U-9	2	4	JIC-G32299	51.90
				I-U-1	2		JIC-D42876	19.32
		2pc		N-N-9		4	JIC-G33239	25.19
BACKHOE SWING		2pc		P-U-9	2	4-1/2	JIC-G32695	75.71
		2pc		P-UB-9	2	4-1/2	JIC-G105525	73.53
LOADER HYDRA-LEVELING		2pc		P-UB-9	1-3/4	3	JIC-G105524	57.47
				P-U-1	1-3/4		JIC-D42872	15.33
		2pc		N-N-9		3	JIC-G33151	20.85
LOADER LIFT		2pc		P-U-9	2	3-1/2	JIC-G34648	48.50
				I-U-1	2		JIC-D42874	16.35
		2pc		N-N-9		3-1/2	JIC-G33237	23.09
LOADER TILT		2pc		P-UB-9	1-3/4	3	JIC-G105524	57.47
				P-U-1	1-3/4		JIC-D42872	15.33
		2pc		N-N-9		3	JIC-G33151	20.85
<b>MODEL 680C</b>								
3-PT HITCH PITCH		1pc		P-UB-10	1-1/2	2-1/2	JIC-G105550	29.30
		2pc		P-U-9	1-1/2	2-1/2	JIC-G32294	35.93
3-PT HITCH TILT		2pc		P-U-9	1-1/2	2-1/2	JIC-G32294	35.93
		1pc		P-UB-10	1-1/2	2-1/2	JIC-G105550	29.30
BACKHOE BOOM		2pc		P-U-9	2-1/4	5	JIC-G32696	75.24
BACKHOE BUCKET		1pc		P-UB-10	1-1/4	2-1/2	JIC-G105551	33.21
		2pc		P-UB-9	2-1/4	4	JIC-G34636	59.90
BACKHOE DIPPER		2pc		P-UB-9	2-1/4	4-1/2	JIC-G105520	88.28
		2pc		P-UB-9	1-1/2	3	JIC-G105512	52.15
				P-U-1	2-1/4		JIC-D42878	18.66
		2pc		N-N-9		4-1/2	JIC-DTVS4.5P	51.78
BACKHOE DIPPER EXT		2pc		P-UB-9	1-1/2	3	JIC-G105512	52.15
BACKHOE STABILIZER		2pc		P-U-9	2	4	JIC-G32299	51.90
		1pc		P-UB-10	2	4	JIC-1543273C1	64.28
		2pc		P-UB-9	2	4	JIC-G105517	54.98
				I-U-1	2		JIC-D42876	19.32
	2pc		N-N-9		4	JIC-G33239	25.19	
BACKHOE SWING		2pc		P-UB-9	2	4-1/2	JIC-G105525	73.53
		2pc		P-U-9	2	4-1/2	JIC-G32695	75.71
LOADER CLAM		1pc		P-UB-10	1-1/2	3	JIC-G105548	39.05
		2pc		P-UB-9	1-1/2	3	JIC-G105512	52.15
LOADER HYDRA-LEVELING		1pc		P-UB-10	1-1/2	3	JIC-G105548	39.05
		2pc		P-UB-9	1-3/4	3	JIC-G105524	57.47
LOADER LIFT		2pc		P-U-9	2	3-1/2	JIC-G34648	48.50
		1pc		P-UB-10	2	3-1/2	JIC-G105546	46.94
		2pc		P-UB-9	2	3-1/2	JIC-G105521	45.75
LOADER TILT		2pc		P-UB-9	1-3/4	3	JIC-G105524	57.47
		1pc		P-UB-10	1-3/4	3	JIC-G105549	49.69
		2pc		P-U-9	1-3/4	3	JIC-G34643	45.91
<b>MODEL 680CK</b>								
BACKHOE BOOM				P-U-1	2-1/4		JIC-D42878	18.66
		2pc		N-N-9		4-1/2	JIC-DTVS4.5P	51.78
BACKHOE BUCKET				I-U-1	2-1/4		JIC-D42877	15.20

CASE



# CASE

Replacement Kits For

Backhoe Loaders								
APPLICATION	CYL #	Piston	SERIAL #	CODE	ROD	BORE	KIT #	List \$
<b>MODEL 680CK</b>								
BACKHOE BUCKET		2pc		N-N-9		4	JIC-G33239	25.19
BACKHOE DIPPER				P-U-1	2-1/4		JIC-D42878	18.66
		2pc		N-N-9		4-1/2	JIC-DTVS4.5P	51.78
BACKHOE STABILIZER				I-U-1	2		JIC-D42876	19.32
		2pc		N-N-9		4	JIC-G33239	25.19
BACKHOE SWING				P-U-1	1-3/4		JIC-D42875	16.26
		2pc		N-N-9		4	JIC-G33239	25.19
LOADER HYDRA-LEVELING				P-U-1	1-3/4		JIC-D42872	15.33
		2pc		N-N-9		3	JIC-G33151	20.85
LOADER LIFT				I-U-1	2		JIC-D42874	16.35
		2pc		N-N-9		3-1/2	JIC-G33237	23.09
LOADER TILT				P-U-1	1-3/4		JIC-D42872	15.33
		2pc		N-N-9		3	JIC-G33151	20.85
<b>MODEL 680E</b>								
BACKHOE BOOM		1pc		P-UB-10	2-1/4	4	JIC-G105556	50.75
		2pc		P-U-9	2-1/4	4	JIC-G34827	59.90
BACKHOE BUCKET		2pc		P-UB-9	2-1/4	4	JIC-G34636	59.90
		1pc		P-UB-10	2-1/4	4	JIC-G105556	50.75
BACKHOE DIPPER		2pc		P-UB-9	2-1/2	4-1/2	JIC-G105513	91.03
BACKHOE DIPPER EXT		1pc		P-UB-10	1-1/2	3	JIC-G105548	39.05
		2pc		P-UB-9	1-1/2	3	JIC-G105512	52.15
BACKHOE STABILIZER		2pc		P-UB-9	2	4-1/2	JIC-G105525	73.53
BACKHOE SWING		1pc		P-UB-10	2	4	JIC-1543273C1	64.28
		2pc		P-UB-9	2	4	JIC-G105517	54.98
LOADER CLAM		1pc		P-UB-10	1-1/2	3	JIC-G105548	39.05
		2pc		P-UB-9	1-1/2	3	JIC-G105512	52.15
LOADER LIFT		1pc		P-UB-10	2	3-1/2	JIC-G105546	46.94
		2pc		P-UB-9	2	3-1/2	JIC-G105521	45.75
LOADER TILT		2pc		P-U-9	1-3/4	3	JIC-G34643	45.91
		1pc		P-UB-10	1-3/4	3	JIC-G105549	49.69
STEERING		1pc		P-U-10	1-1/4	2-1/8	JIC-G34819	23.65
		1pc		P-U-10	1-1/4	2-1/8	JIC-G101021	22.99
		1pc		I-U-10	1-1/4	2-1/8	JIC-A43296	21.77
<b>MODEL 680G, 680H</b>								
BACKHOE BOOM		1pc		P-UB-10	2-1/4	4	JIC-G105556	50.75
BACKHOE BUCKET		1pc		P-UB-10	2-1/4	4	JIC-G105556	50.75
BACKHOE DIPPER		2pc		P-UB-9	2-1/2	4-1/2	JIC-G105513	91.03
BACKHOE DIPPER EXT		1pc		P-UB-10	1-1/2	3	JIC-G105548	39.05
BACKHOE STABILIZER		2pc		P-UB-9	2	4-1/2	JIC-G105525	73.53
BACKHOE SWING		1pc		P-UB-10	2	4	JIC-1543273C1	64.28
LOADER CLAM		1pc		P-UB-10	1-1/2	3	JIC-G105548	39.05
LOADER LIFT		1pc		P-UB-10	2	3-1/2	JIC-G105546	46.94
LOADER TILT		1pc		P-UB-10	1-3/4	3	JIC-G105549	49.69
STEERING		1pc		P-U-10	1-1/4	2-1/8	JIC-G34819	23.65
<b>MODEL 680K</b>								
BACKHOE BOOM		1pc		P-UB-10	2-1/4	4	JIC-G109505	46.61
BACKHOE BUCKET		1pc		P-UB-10	2-1/4	4	JIC-G109505	46.61
BACKHOE DIPPER		2pc		P-UB-9	2-1/2	4-1/2	JIC-G109498	83.96
BACKHOE DIPPER EXT		1pc		P-UB-10	1-1/2	3	JIC-G109452	29.65
BACKHOE SWING		1pc		P-UB-10	2	4	JIC-1543273C1	64.28
LOADER CLAM		1pc		P-UB-10	1-1/2	3	JIC-G109452	29.65
LOADER LIFT		1pc		P-UB-10	2	3-1/2	JIC-G109453	43.95
LOADER TILT		1pc		P-UB-10	1-3/4	3	JIC-1543262C1	40.59
STEERING		1pc		P-U-10	1-1/4	2-1/8	JIC-G34819	23.65



# CASE

Replacement Kits For

<b>Backhoe Loaders</b>								
APPLICATION	CYL #	Piston	SERIAL #	CODE	ROD	BORE	KIT #	List \$
<b>MODEL 680L</b>								
BACKHOE BOOM	1343567C1	1pc		P-UB-10	2-1/4	4	JIC-1346478C2	84.36
	G101256	1pc		P-UB-10	2-1/4	4	JIC-1543277C1	56.84
BACKHOE BUCKET	1343602C1	1pc		P-UB-10	2-1/4	4	JIC-1346478C2	84.36
	G103856	1pc		P-UB-10	2-1/4	4	JIC-1543277C1	56.84
BACKHOE DIPPER	1345994C1	1pc		P-UB-10	2-1/2	4-1/2	JIC-1343707C2	67.20
	G101348	2pc		P-UB-9	2-1/2	4-1/2	JIC-1543291C1	85.37
BACKHOE DIPPER EXT	1980375C1	1pc		P-UB-10	1-1/2	3	JIC-1543256C1	39.76
BACKHOE STABILIZER	1986853C1	1pc		P-UB-10	2	4-1/2	JIC-1986856C2	84.94
	G102276	2pc		P-UB-9	2	4-1/2	JIC-1543270C1	93.22
BACKHOE SWING	1978339C1	1pc		P-UB-10	2	4	JIC-1543269C1	61.25
LOADER CLAM	D143217	1pc		P-UB-10	2	4	JIC-D143215	30.10
LOADER LIFT	G103073	1pc	-JJG007050523, 526, 540, 547 & UP	P-UB-10	2-1/4	4	JIC-1543277C1	56.84
	G103457	1pc	-JJG0070547, except 423, 526, & 540	P-UB-10	2	3-1/2	JIC-1543274C1	65.64
LOADER TILT	G101220	1pc		P-UB-10	1-3/4	3	JIC-1543262C1	40.59
<b>MODEL 780</b>								
BACKHOE BOOM		2pc		P-UB-9	2-1/2	4-1/2	JIC-G105513	91.03
BACKHOE BUCKET		2pc	-5500549	P-U-9	3	5	JIC-G32668	76.65
		2pc	5500550-	P-UB-9	3	5	JIC-G105531	88.67
BACKHOE DIPPER		2pc		P-UB-9	3	6	JIC-G105516	95.29
BACKHOE DIPPER EXT		1pc		P-UB-10	2-1/4	4	JIC-G105556	50.75
		2pc		P-UB-9	2-1/4	4	JIC-G34636	59.90
BACKHOE STABILIZER		2pc		P-UB-9	2-1/2	4-1/2	JIC-G105513	91.03
BACKHOE SWING		2pc		P-UB-9	2-1/4	4-1/2	JIC-G105520	88.28
LOADER CLAM		2pc		P-U-9	2	4	JIC-G32299	51.90
		1pc		P-UB-10	2	4	JIC-1543273C1	64.28
LOADER HYDRA-LEVELING		2pc		P-UB-9	2	4	JIC-G105517	54.98
LOADER LIFT		2pc		P-UB-9	2-1/4	4-1/2	JIC-G105520	88.28
LOADER TILT		2pc		P-U-9	1-3/4	3-1/2	JIC-G32228	39.76
		2pc		P-U-9	1-3/4	3-1/2	JIC-G105508	48.49
<b>MODEL 780B</b>								
BACKHOE BOOM		1pc	ALL	P-UB-10	2-1/2	4-1/2	JIC-G105560	48.77
BACKHOE BUCKET		1pc	ALL	P-UB-10	2-1/2	4-1/2	JIC-G105560	48.77
BACKHOE DIPPER		1pc		P-UB-10	2-3/4	5	JIC-G105562	73.20
BACKHOE DIPPER EXT		1pc		P-UB-10	1-1/2	3	JIC-G105548	39.05
BACKHOE STABILIZER		1pc		P-UB-10	2-1/4	4-1/2	JIC-G105557	65.36
BACKHOE SWING		1pc		P-UB-10	2	4	JIC-1543273C1	64.28
LOADER CLAM		1pc		P-UB-10	2	4	JIC-1543273C1	64.28
LOADER LIFT		1pc		P-UB-10	2-1/4	4	JIC-G105556	50.75
LOADER TILT		1pc		P-UB-10	2	3-1/2	JIC-G105546	46.94
STEERING		1pc		P-U-10	1-1/4	2-1/8	JIC-G34819	23.65
<b>Crawler Dozers/Loaders</b>								
APPLICATION	CYL #	Piston	SERIAL #	CODE	ROD	BORE	KIT #	List \$
<b>MODEL 310E, 310F with Backhoe Model 31</b>								
BACKHOE BOOM		2pc		P-U-9	2	4	JIC-G32616	49.91
				I-U-1	2		JIC-D42876	19.32
		2pc		N-N-9		4	JIC-G33239	25.19
BACKHOE BUCKET		2pc		P-U-9	1-3/4	3-1/2	JIC-G105518	44.55
				P-U-1	1-3/4		JIC-D42873	21.01
		2pc		N-N-9		3-1/2	JIC-G33237	23.09
BACKHOE DIPPER		2pc		P-UB-9	2	4	JIC-G105526	54.90
				I-U-1	2		JIC-D42876	19.32
		2pc		N-N-9		4	JIC-G33239	25.19
BACKHOE STABILIZER				P-U-1	1-3/4		JIC-D42873	21.01
		2pc		N-N-9		3-1/2	JIC-G33237	23.09

CASE



# CASE

Replacement Kits For

Crawler Dozers/Loaders								
APPLICATION	CYL #	Piston	SERIAL #	CODE	ROD	BORE	KIT #	List \$
<b>MODEL 310E, 310F with Backhoe Model 31</b>								
BACKHOE SWING		2pc		N-N-9		4	JIC-G33239	25.19
			2019001-3023000	P-U-1	1-3/4		JIC-D42875	16.26
DOZER ANGLING				P-U-1	1-3/4		JIC-D42873	21.01
		2pc		N-N-9		3-1/2	JIC-G33237	23.09
DOZER LIFT				P-U-1	1-1/4		JIC-D42867	19.12
		2pc		N-N-9		2-1/2	JIC-G33193	20.35
DOZER TILT				P-U-1	1-1/4		JIC-D42867	19.12
		2pc		N-N-9		2-1/2	JIC-G33193	20.35
LOADER LIFT				P-U-1	1-3/4		JIC-D42873	21.01
		2pc		N-N-9		3-1/2	JIC-G33237	23.09
LOADER TILT				P-U-1	1-1/4		JIC-D42867	19.12
		2pc		N-N-9		2-1/2	JIC-G33193	20.35
SCARIFIER				P-U-1	1-1/2		JIC-D42870	20.47
		2pc		N-N-9		3	JIC-G33151	20.85
<b>MODEL 310G with Backhoe Models 26, 26B, 26S, 32, 33</b>								
BACKHOE BOOM			3023001.3032323	P-U-1	1-3/4		JIC-D42873	21.01
		2pc	3023001.3032324	N-N-9		3-1/2	JIC-G33237	23.09
		2pc	3023001.3032325	P-UB-9	1-3/4	3-1/2	JIC-G105529	41.78
		2pc	3023001.3032326	P-UB-9	2-1/4	4	JIC-G34636	59.90
			3023001.3032327	I-U-1	2		JIC-D42876	19.32
		2pc	3023001.3032328	N-N-9		4	JIC-G33239	25.19
		2pc	3023001.3032329	P-U-9	2	4	JIC-G32299	51.90
		2pc	3023001.3032330	P-UB-9	2	4	JIC-G105517	54.98
			3023001.3032331	P-U-1	2-1/4		JIC-D42878	18.66
		2pc	3023001.3032332	N-N-9		4-1/2	JIC-DTVS4.5P	51.78
		2pc	3023001.3032333	P-UB-9	2-1/4	4-1/2	JIC-G105520	88.28
BACKHOE BUCKET			3023001.3032334	P-U-1	1-3/4		JIC-D42872	15.33
		2pc	3023001.3032335	N-N-9		3-1/2	JIC-G33237	23.09
		2pc	3023001.3032336	P-UB-9	1-3/4	3	JIC-G105524	57.47
			3023001.3032337	P-U-1	1-3/4		JIC-D42873	21.01
		2pc	3023001.3032338	N-N-9		3-1/2	JIC-G33237	23.09
			3023001.3032339	I-U-1	2		JIC-D42874	16.35
		2pc	3023001.3032340	N-N-9		3-1/2	JIC-G33237	23.09
		2pc	3023001.3032341	P-U-9	2	3-1/2	JIC-G32293	40.26
		2pc	3023001.3032342	P-UB-9	2	3-1/2	JIC-G105527	52.45
BACKHOE DIPPER			3023001.3032343	I-U-1	2		JIC-D42874	16.35
		2pc	3023001.3032344	N-N-9		3-1/2	JIC-G33237	23.09
		2pc	3023001.3032345	P-U-9	2	3-1/2	JIC-G32293	40.26
		2pc	3023001.3032346	P-UB-9	2	3-1/2	JIC-G105527	52.45
			3023001.3032347	I-U-1	2		JIC-D42876	19.32
		2pc	3023001.3032348	N-N-9		4	JIC-G33239	25.19
		2pc	3023001.3032349	P-U-9	2	4	JIC-G32299	51.90
		2pc	3023001.3032350	P-UB-9	2	4	JIC-G105517	54.98
		2pc	3023001.3032351	P-UB-9	1-1/2	3	JIC-G105512	52.15
BACKHOE STABILIZER			3023001.3032308	P-U-1	1-1/2		JIC-D42870	20.47
		2pc	3023001.3032309	N-N-9		3	JIC-G33151	20.85
			3023001.3032310	P-U-1	1-3/4		JIC-D42872	15.33
		2pc	3023001.3032311	N-N-9		3	JIC-G33151	20.85
		2pc	3023001.3032312	P-UB-9	1-3/4	3	JIC-G105524	57.47
			3023001.3032313	P-U-1	1-3/4		JIC-D42873	21.01
		2pc	3023001.3032314	N-N-9		3-1/2	JIC-G33237	23.09
		2pc	3023001.3032315	P-UB-9	1-3/4	3-1/2	JIC-G105529	41.78
		2pc	3023001.3032316	P-U-9	1-3/4	3-1/2	JIC-G105518	44.55
BACKHOE SWING			3023001.3032317	P-U-1	1-1/2		JIC-D47896	16.51
		2pc	3023001.3032318	N-N-9		3-1/2	JIC-G33237	23.09



# CASE

Replacement Kits For

Crawler Dozers/Loaders								
APPLICATION	CYL #	Piston	SERIAL #	CODE	ROD	BORE	KIT #	List \$
<b>MODEL 310G with Backhoe Models 26, 26B, 26S, 32, 33</b>								
BACKHOE SWING		2pc	3023001.3032319	P-U-9	1-1/2	3-1/2	JIC-G34652	39.20
		2pc	3023001.3032320	P-UB-9	1-3/4	4	JIC-G105519	49.76
			3023001.3032321	P-U-1	1-3/4		JIC-D42875	16.26
		2pc	3023001.3032322	N-N-9		4	JIC-G33239	25.19
DOZER ANGLING		2pc	3023001.3032301	P-U-9	1-3/4	3-1/2	JIC-G34622	44.55
			3023001.3032301	P-U-1	1-3/4		JIC-D42873	21.01
		2pc	3023001.3032301	N-N-9		3-1/2	JIC-G33237	23.09
			3023001.3032302	P-U-1	1-1/2		JIC-D42870	20.47
		2pc	3023001.3032303	N-N-9		3	JIC-G33151	20.85
		2pc	3023001.3032304	P-UB-9	1-1/2	3	JIC-G105512	52.15
DOZER LIFT		2pc	3023001.3032301	P-U-9	1-1/4	2-1/2	JIC-G32295	45.16
			3023001.3032301	P-U-1	1-1/4		JIC-D42867	19.12
		2pc	3023001.3032301	N-N-9		2-1/2	JIC-G33193	20.35
DOZER TILT		2pc	3023001.3032301	P-U-9	1-1/4	2-1/2	JIC-G32295	45.16
			3023001.3032301	P-U-1	1-1/4		JIC-D42867	19.12
		2pc	3023001.3032301	N-N-9		2-1/2	JIC-G33193	20.35
EXTENSION			3023001.3032352	P-U-1	1-3/4		JIC-D42873	21.01
		2pc	3023001.3032353	N-N-9		3-1/2	JIC-G33237	23.09
		2pc	3023001.3032354	P-UB-9	1-3/4	3-1/2	JIC-G105529	41.78
LOADER CLAM	G32460	2pc	3023001.3032301	P-UB-9	1-3/4	3	JIC-G105524	57.47
LOADER GRAPPLE		2pc	3023001.3032301	P-U-9	1-1/2	2-1/2	JIC-G32294	35.93
			3023001.3032301	P-U-1	1-1/2		JIC-D42869	20.62
		2pc	3023001.3032301	N-N-9		2-1/2	JIC-G33193	20.35
LOADER HYDRA-LEVELING	D33123	2pc	3023001.3032301	P-U-9	1-1/2	2-1/2	JIC-G32294	35.93
	D33123	2pc	3023001.3032301	P-U-1	1-1/2		JIC-D42869	20.62
	D33123	2pc	3023001.3032301	N-N-9		2-1/2	JIC-G33193	20.35
LOADER LIFT		2pc	3023001.3032301	P-UB-9	1-3/4	3	JIC-G105524	57.47
	D33121, D33122		3023001.3032301	P-U-1	1-3/4		JIC-D42872	15.33
	D33121, D33122	2pc	3023001.3032301	N-N-9		3	JIC-G33151	20.85
LOADER TILT		2pc	3023001.3032301	N-N-9		2-1/2	JIC-G33193	20.35
	D33113, D33114	2pc	3023001.3032301	P-U-9	1-1/2	2-1/2	JIC-G32294	35.93
	D33113, D33114		3023001.3032301	P-U-1	1-1/2		JIC-D42869	20.62
RIPPER			3023001.3032305	P-U-1	1-1/2		JIC-D42870	20.47
		2pc	3023001.3032306	N-N-9		3	JIC-G33151	20.85
		2pc	3023001.3032307	P-UB-9	1-1/2	3	JIC-G105512	52.15
<b>MODEL 350 with Backhoe Models 26, 26B, 26C, 26S</b>								
BACKHOE BOOM		1pc		P-UB-10	2-1/4	4	JIC-G105556	50.75
		2pc		P-UB-9	1-3/4	3-1/2	JIC-G105529	41.78
		2pc		P-UB-9	2-1/4	4	JIC-G34636	59.90
				P-U-1	1-3/4		JIC-D42873	21.01
		2pc		N-N-9		3-1/2	JIC-G33237	23.09
BACKHOE BUCKET		2pc		P-UB-9	1-3/4	3	JIC-G105524	57.47
		1pc		P-UB-10	1-3/4	3	JIC-G105549	49.69
				P-U-1	1-3/4		JIC-D42872	15.33
BACKHOE DIPPER		2pc		N-N-9		3-1/2	JIC-G33237	23.09
		1pc		P-UB-10	2	3-1/2	JIC-G105546	46.94
		2pc		P-U-9	2	3-1/2	JIC-G32293	40.26
		2pc		P-UB-9	2	3-1/2	JIC-G105527	52.45
				I-U-1	2		JIC-D42874	16.35
BACKHOE DIPPER EXT		2pc		N-N-9		3-1/2	JIC-G33237	23.09
		1pc		P-UB-10	1-1/2	3	JIC-G105548	39.05
	2pc			P-UB-9	1-1/2	3	JIC-G105512	52.15

CASE



# CASE

Replacement Kits For

Crawler Dozers/Loaders								
APPLICATION	CYL #	Piston	SERIAL #	CODE	ROD	BORE	KIT #	List \$
<b>MODEL 350 with Backhoe Models 26, 26B, 26C, 26S</b>								
BACKHOE STABILIZER		2pc		P-UB-9	1-3/4	3	JIC-G105524	57.47
		2pc		P-UB-9	1-3/4	3-1/2	JIC-G105529	41.78
		2pc		P-U-9	1-3/4	3-1/2	JIC-G105518	44.55
				P-U-1	1-3/4		JIC-D42872	15.33
				P-U-1	1-1/2		JIC-D42870	20.47
		2pc		N-N-9		3	JIC-G33151	20.85
BACKHOE SWING		2pc		P-U-9	1-1/2	3-1/2	JIC-G34652	39.20
		1pc		P-UB-10	1-1/2	3-1/2	JIC-G105555	36.74
		2pc		P-UB-9	1-3/4	4	JIC-G105519	49.76
				P-U-1	1-1/2		JIC-D47896	16.51
			2pc		N-N-9		3-1/2	JIC-G33237
DOZER ANGLE		2pc		P-U-9	1-3/4	3-1/2	JIC-G105518	44.55
				P-U-1	1-3/4		JIC-D42873	21.01
		2pc		N-N-9		3-1/2	JIC-G33237	23.09
DOZER ANGLE (Angle Tilt Dozer)		1pc		P-UB-10	1-1/2	3	JIC-G105548	39.05
		2pc		P-UB-9	1-1/2	3	JIC-G105512	52.15
				P-U-1	1-1/2		JIC-D42870	20.47
		2pc		N-N-9		3	JIC-G33151	20.85
DOZER LIFT		2pc		P-U-9	1-1/4	2-1/2	JIC-G32295	45.16
		1pc		P-UB-10	1-1/4	2-1/2	JIC-G105551	33.21
				P-U-1	1-1/4		JIC-D42867	19.12
		2pc		N-N-9		2-1/2	JIC-G33193	20.35
DOZER TILT		2pc		P-U-9	1-1/4	2-1/2	JIC-G32295	45.16
		1pc		P-UB-10	1-1/4	2-1/2	JIC-G105551	33.21
				P-U-1	1-1/4		JIC-D42867	19.12
		2pc		N-N-9		2-1/2	JIC-G33193	20.35
LOADER CLAM		1pc		P-UB-10	1-3/4	3	JIC-G105549	49.69
		2pc		P-UB-9	1-3/4	3	JIC-G105524	57.47
LOADER GRAPPLE		1pc		P-UB-10	1-1/2	2-1/2	JIC-G105550	29.30
		2pc		P-U-9	1-1/2	2-1/2	JIC-G32294	35.93
				P-U-1	1-1/2		JIC-D42869	20.62
		2pc		N-N-9		2-1/2	JIC-G33193	20.35
		1pc		P-UB-10	1-1/2	2-1/2	JIC-G105550	29.30
LOADER HYDRA-LEVELING		2pc		P-U-9	1-1/2	2-1/2	JIC-G32294	35.93
				P-U-1	1-1/2		JIC-D42869	20.62
		2pc		N-N-9		2-1/2	JIC-G33193	20.35
		1pc		P-UB-10	1-1/2	2-1/2	JIC-G105549	49.69
LOADER LIFT		2pc		P-U-9	1-3/4	3	JIC-G34643	45.91
		2pc		P-UB-9	1-3/4	3	JIC-G105524	57.47
				P-U-1	1-3/4		JIC-D42872	15.33
		2pc		N-N-9		3	JIC-G33151	20.85
		1pc		P-UB-10	1-1/2	2-1/2	JIC-G105550	29.30
LOADER TILT		2pc		P-U-9	1-1/2	2-1/2	JIC-G32294	35.93
				P-U-1	1-1/2		JIC-D42869	20.62
		2pc		N-N-9		2-1/2	JIC-G33193	20.35
		1pc		P-UB-10	1-1/2	3	JIC-G105548	39.05
RIPPER		2pc		P-UB-9	1-1/2	3	JIC-G105512	52.15
				P-U-1	1-1/2		JIC-D42870	20.47
		2pc		N-N-9		3	JIC-G33151	20.85
	<b>MODEL 350B with Backhoe Models 26C, 26D</b>							
BACKHOE BOOM		1pc		P-UB-10	1-3/4	4	JIC-G105552	46.78
		1pc		P-UB-10	2-1/4	4	JIC-G105556	50.75
		2pc		P-UB-9	2-1/4	4	JIC-G34636	59.90
BACKHOE BUCKET		1pc		P-UB-10	2	3-1/4	JIC-G105553	49.22
		1pc		P-UB-10	1-3/4	3	JIC-G105549	49.69





# CASE

Replacement Kits For

Crawler Dozers/Loaders								
APPLICATION	CYL #	Piston	SERIAL #	CODE	ROD	BORE	KIT #	List \$
<b>MODEL 350B with Backhoe Models 26C, 26D</b>								
BACKHOE BUCKET		2pc		P-UB-9	1-3/4	3	JIC-G105524	57.47
BACKHOE DIPPER		1pc		P-UB-10	2	3-1/2	JIC-G105546	46.94
		2pc		P-UB-9	2	3-1/2	JIC-G105527	52.45
BACKHOE DIPPER EXT		2pc		P-UB-9	1-1/2	3	JIC-G105512	52.15
		1pc		P-UB-10	1-1/2	3	JIC-G105548	39.05
BACKHOE STABILIZER		1pc		P-UB-10	1-3/4	3	JIC-G105549	49.69
		2pc		P-U-9	1-3/4	3-1/2	JIC-G105518	44.55
BACKHOE SWING		1pc		P-UB-10	1-1/2	3-1/2	JIC-G105555	36.74
		2pc		P-U-9	1-1/2	3-1/2	JIC-G34652	39.20
DOZER ANGLE		1pc		P-UB-10	1-1/2	3	JIC-G109452	29.65
DOZER LIFT		1pc		P-UB-10	1-1/4	2-1/2	JIC-G109475	33.21
DOZER TILT		1pc		P-UB-10	1-1/4	2-1/2	JIC-G109475	33.21
LOADER CLAM		1pc		P-UB-10	1-3/4	3	JIC-1543262C1	40.59
LOADER LIFT		1pc		P-UB-10	1-3/4	3	JIC-1543262C1	40.59
LOADER TILT		1pc		P-UB-10	1-1/2	2-1/2	JIC-1543253C1	43.06
RIPPER		1pc		P-UB-10	1-1/2	3	JIC-G109452	29.65
<b>MODEL 420C</b>								
BACKHOE BOOM				I-U-1	2		JIC-D42876	19.32
		2pc		N-N-9		4	JIC-G33239	25.19
BACKHOE BUCKET				P-U-1	1-3/4		JIC-D42873	21.01
		2pc		N-N-9		3-1/2	JIC-G33237	23.09
BACKHOE DIPPER				I-U-1	2		JIC-D42876	19.32
		2pc		N-N-9		4	JIC-G33239	25.19
BACKHOE STABILIZER				P-U-1	1-3/4		JIC-D42873	21.01
		2pc		N-N-9		3-1/2	JIC-G33237	23.09
DOZER ANGLING				P-U-1	1-3/4		JIC-D42873	21.01
		2pc		N-N-9		3-1/2	JIC-G33237	23.09
DOZER LIFT				P-U-1	1-1/4		JIC-D42867	19.12
		2pc		N-N-9		4	JIC-G33239	25.19
DOZER TILT				P-U-1	1-1/4		JIC-D42867	19.12
		2pc		N-N-9		4	JIC-G33239	25.19
LOADER LIFT				P-U-1	1-3/4		JIC-D42873	21.01
		2pc		N-N-9		3-1/2	JIC-G33237	23.09
LOADER TILT				P-U-1	1-1/4		JIC-D42867	19.12
		2pc		N-N-9		4	JIC-G33239	25.19
SCARIFIER				P-U-1	1-1/2		JIC-D42870	20.47
		2pc		N-N-9		4	JIC-G33239	25.19
<b>MODEL 450 with Backhoe Models 26, 26B, 26C, 26S, 32, 33, 35</b>								
BACKHOE BOOM		1pc		P-UB-10	2-1/4	4	JIC-G105556	50.75
		1pc		P-UB-10	1-3/4	3-1/4	JIC-G105547	44.90
		2pc		P-UB-9	2-1/4	4	JIC-G34636	59.90
		2pc		P-UB-9	1-3/4	3-1/4	JIC-G105528	47.83
		2pc		P-UB-9	2	4	JIC-G105517	54.98
		2pc		P-U-9	2	4	JIC-G32299	51.90
		2pc		P-UB-9	2-1/4	4-1/2	JIC-G105520	88.28
		2pc		P-UB-9	1-3/4	3-1/2	JIC-G105529	41.78
				P-U-1	1-3/4		JIC-D42873	21.01
				P-U-1	2-1/4		JIC-D42878	18.66
				I-U-1	2		JIC-D42876	19.32
		2pc		N-N-9		4-1/2	JIC-DTVS4.5P	51.78
		2pc		N-N-9		4	JIC-G33239	25.19
		2pc		N-N-9		3-1/2	JIC-G33237	23.09
BACKHOE BUCKET		2pc		P-U-9	2	3-1/2	JIC-G32293	40.26
		2pc		P-UB-9	2	3-1/2	JIC-G105527	52.45
		2pc		P-UB-9	1-3/4	3	JIC-G105524	57.47

CASE



# CASE

Replacement Kits For

Crawler Dozers/Loaders									
APPLICATION	CYL #	Piston	SERIAL #	CODE	ROD	BORE	KIT #	List \$	
MODEL 450 with Backhoe Models 26, 26B, 26C, 26S, 32, 33, 35									
BACKHOE BUCKET		1pc		P-UB-10	2	3-1/2	JIC-G105546	46.94	
		1pc		P-UB-10	1-3/4	3	JIC-G105549	49.69	
				P-U-1	1-3/4		JIC-D42872	15.33	
				P-U-1	1-3/4		JIC-D42873	21.01	
				I-U-1	2		JIC-D42874	16.35	
		2pc		N-N-9			3-1/2	JIC-G33237	23.09
BACKHOE DIPPER		1pc		P-UB-10	2	4	JIC-1543273C1	64.28	
		2pc		P-UB-9	2	3-1/2	JIC-G105527	52.45	
		2pc		P-U-9	2	4	JIC-G32299	51.90	
		2pc		P-UB-9	2	4	JIC-G105517	54.98	
		2pc		P-U-9	2	3-1/2	JIC-G32293	40.26	
		1pc		P-UB-10	2	3-1/2	JIC-G105546	46.94	
				I-U-1	2		JIC-D42876	19.32	
				I-U-1	2		JIC-D42874	16.35	
		2pc		N-N-9			3-1/2	JIC-G33237	23.09
		2pc		N-N-9			4	JIC-G33239	25.19
BACKHOE DIPPER EXT		2pc		P-UB-9	1-3/4	3-1/2	JIC-G105529	41.78	
		2pc		P-UB-10	1-1/2	3	JIC-G105548	39.05	
		2pc		P-UB-9	1-1/2	3	JIC-G105512	52.15	
		2pc		P-U-1	1-3/4		JIC-D42873	21.01	
		2pc		N-N-9			3-1/2	JIC-G33237	23.09
BACKHOE STABILIZER		2pc		P-UB-9	2	4	JIC-G105517	54.98	
		2pc		P-UB-9	1-3/4	3	JIC-G105524	57.47	
		2pc		P-U-9	1-3/4	3-1/2	JIC-G105518	44.55	
		2pc		P-UB-9	1-3/4	3-1/2	JIC-G105529	41.78	
		1pc		P-UB-10	2	4	JIC-1543273C1	64.28	
				P-U-1	1-1/2		JIC-D42870	20.47	
				P-U-1	1-3/4		JIC-D42873	21.01	
				P-U-1	1-3/4		JIC-D42872	15.33	
		2pc		N-N-9			3	JIC-G33151	20.85
		2pc		N-N-9			3-1/2	JIC-G33237	23.09
	BACKHOE SWING		1pc		P-UB-10	2	4	JIC-1543273C1	64.28
			1pc		P-UB-10	1-1/2	3-1/2	JIC-G105555	36.74
		2pc		P-UB-9	2	4	JIC-G105517	54.98	
		2pc		P-UB-9	1-3/4	4	JIC-G105519	49.76	
		2pc		P-U-9	1-1/2	3-1/2	JIC-G34652	39.20	
				P-U-1	1-1/2		JIC-D47896	16.51	
				P-U-1	1-3/4		JIC-D42875	16.26	
		2pc		N-N-9			4	JIC-G33239	25.19
		2pc		N-N-9			3-1/2	JIC-G33237	23.09
DOZER ANGLING (Angle Dozer)			2pc		I-U-9	1-1/2	2	JIC-D37361	29.95
		2pc		P-UB-9	1-1/2	2	JIC-G105503	37.17	
DOZER ANGLING (Angle Tilt Dozer)		2pc		P-UB-9	2	4	JIC-G105526	54.90	
		1pc		P-UB-10	2	4	JIC-1543273C1	64.28	
				I-U-1	2		JIC-D42876	19.32	
		2pc		N-N-9			4	JIC-G33239	25.19
DOZER LIFT		2pc		P-U-9	1-1/4	2-1/2	JIC-G32295	45.16	
		1pc		P-UB-10	1-1/4	2-1/2	JIC-G105551	33.21	
				P-U-1	1-1/4		JIC-D42867	19.12	
	2pc		N-N-9			2-1/2	JIC-G33193	20.35	
DOZER TILT		1pc		P-UB-10	2	3-1/2	JIC-G105546	46.94	
		2pc		P-UB-9	2	3-1/2	JIC-G105521	45.75	
		2pc		P-U-9	2	3-1/2	JIC-G34648	48.50	
				I-U-1	2		JIC-D42874	16.35	



# CASE

Replacement Kits For

Crawler Dozers/Loaders								
APPLICATION	CYL #	Piston	SERIAL #	CODE	ROD	BORE	KIT #	List \$
<b>MODEL 450 with Backhoe Models 26, 26B, 26C, 26S, 32, 33, 35</b>								
DOZER TILT		2pc		N-N-9		3-1/2	JIC-G33237	23.09
LOADER CLAM		2pc		P-UB-9	1-1/2	3	JIC-G105512	52.15
		1pc		P-UB-10	1-1/2	3	JIC-G105548	39.05
				P-U-1	1-1/2		JIC-D42870	20.47
		2pc		N-N-9		3	JIC-G33151	20.85
LOADER HYDRA-LEVELING		2pc		P-UB-9	1-3/4	3	JIC-G105524	57.47
		1pc		P-UB-10	1-3/4	3	JIC-G105549	49.69
				P-U-1	1-3/4		JIC-D42872	15.33
		2pc		N-N-9		3	JIC-G33151	20.85
LOADER LIFT		1pc		P-UB-10	2	3-1/2	JIC-G105546	46.94
		2pc		P-U-9	2	3-1/2	JIC-G34648	48.50
		2pc		P-UB-9	2	3-1/2	JIC-G105521	45.75
				I-U-1	2		JIC-D42874	16.35
		2pc		N-N-9		3-1/2	JIC-G33237	23.09
LOADER TILT		2pc		P-UB-9	1-3/4	3	JIC-G105524	57.47
		1pc		P-UB-10	1-3/4	3	JIC-G105549	49.69
		2pc		P-U-9	1-3/4	3	JIC-G34643	45.91
				P-U-1	1-3/4		JIC-D42872	15.33
		2pc		N-N-9		3	JIC-G33151	20.85
		2pc		P-UB-9	1-1/2	3	JIC-G105512	52.15
RIPPER		1pc		P-UB-10	1-1/2	3	JIC-G105548	39.05
				P-U-1	1-1/2		JIC-D42870	20.47
		2pc		N-N-9		3-1/2	JIC-G33237	23.09
<b>MODEL 450B, 450C, 455B, 455C with Backhoe Models 26D, 35</b>								
BACKHOE BOOM		1pc		P-UB-10	1-3/4	4	JIC-G105552	46.78
		2pc		P-UB-9	1-3/4	3-1/4	JIC-G105528	47.83
		1pc		P-UB-10	1-3/4	3-1/4	JIC-G105547	44.90
BACKHOE BUCKET		1pc		P-UB-10	2	3-1/2	JIC-G105546	46.94
		1pc		P-UB-10	2	3-1/4	JIC-G105553	49.22
		2pc		P-UB-9	2	3-1/2	JIC-G105527	52.45
BACKHOE DIPPER		1pc		P-UB-10	2	4	JIC-1543273C1	64.28
		2pc		P-UB-9	2	4	JIC-G105517	54.98
		1pc		P-UB-10	2	3-1/2	JIC-G105546	46.94
BACKHOE DIPPER EXT		1pc		P-UB-10	1-1/2	3	JIC-G105548	39.05
		2pc		P-UB-9	1-1/2	3	JIC-G105512	52.15
BACKHOE STABILIZER		2pc		P-UB-9	2	4	JIC-G105517	54.98
		1pc		P-UB-10	1-3/4	3	JIC-G105549	49.69
		1pc		P-UB-10	2	4	JIC-1543273C1	64.28
BACKHOE SWING		1pc		P-UB-10	1-1/2	3-1/2	JIC-G105555	36.74
		2pc		P-UB-10	2	4	JIC-1543273C1	64.28
		2pc		P-UB-9	2	4	JIC-G105517	54.98
DOZER ANGLE		1pc		P-UB-10	2	4	JIC-1543273C1	64.28
DOZER LIFT		1pc		P-UB-10	1-1/4	2-1/2	JIC-G105551	33.21
DOZER TILT		1pc		P-UB-10	2	3-1/2	JIC-G105546	46.94
LOADER CLAM		1pc		P-UB-10	1-1/2	3	JIC-G105548	39.05
LOADER HYDRA-LEVELING		1pc		P-UB-10	2	4	JIC-1543273C1	64.28
LOADER LIFT		1pc		P-UB-10	2	3-1/2	JIC-G105546	46.94
LOADER TILT		1pc		P-UB-10	1-1/2	3	JIC-G105548	39.05
RIPPER		1pc		P-UB-10	1-1/2	3	JIC-G105548	39.05
<b>MODEL 475 Cable Laver</b>								
DOZER TILT		1pc		P-UB-10	2	3-1/2	JIC-G105546	46.94
		2pc		P-U-9	2	3-1/2	JIC-G34648	48.50
PLOW LIFT		2pc		P-UB-9	2	4-1/2	JIC-G105525	73.53
PLOW SWING		1pc		P-UB-10	1-1/2	3-1/2	JIC-G105555	36.74
		2pc		P-U-9	1-1/2	3-1/2	JIC-G34646	38.55

CASE



# CASE

Replacement Kits For

Crawler Dozers/Loaders								
APPLICATION	CYL #	Piston	SERIAL #	CODE	ROD	BORE	KIT #	List \$
<b>MODEL 475 Cable Layer</b>								
REEL & DOZER LIFT		2pc		P-U-9	1-1/4	2-1/2	JIC-G32295	45.16
		1pc		P-UB-10	1-1/4	2-1/2	JIC-G105551	33.21
<b>MODEL 550E</b>								
ANGLE	140146A1			P-UB-10	2	4	JIC-1543273C1	64.28
LIFT	1542565C1			I-UB-10	1-1/2	2-1/2	JIC-1542764C2	51.47
RIPPER	G101230			P-UB-10	1-1/2	3	JIC-1543252C1	42.22
TILT	1542717C1			P-UB-10	1-1/2	3	JIC-1543256C1	39.76
<b>MODEL 550G</b>								
ANGLE	140146A1			P-UB-10	2	4	JIC-1543273C1	64.28
LIFT	1542565C1			I-UB-10	1-1/2	2-1/2	JIC-1542764C2	51.47
RIPPER	G101230			P-UB-10	1-1/2	3	JIC-1543252C1	42.22
TILT	1542717C1			P-UB-10	1-1/2	3	JIC-1543256C1	39.76
<b>MODEL 550H</b>								
ANGLE	307662A1		12/99-	P-UB-10	1-3/4	3	JIC-310478A1	58.83
LIFT	307112A1		12/99-	P-UB-10	1-3/4	3	JIC-1543267C1	49.14
RIPPER	G101230		12/99-	P-UB-10	1-1/2	3	JIC-1543252C1	42.22
TILT	347202A1		12/99-	P-UB-10	1-3/4	3-1/2	JIC-1543266C1	50.06
<b>MODEL 650G</b>								
ANGLE	116969A1			P-UB-10	1-3/4	3-1/2	JIC-1543266C1	50.06
	190595A1			P-UB-10	1-3/4	3-1/2	JIC-1543266C1	50.06
	190595A2			P-UB-10	1-3/4	3-1/2	JIC-250741A1	64.23
LIFT	116211A1			P-UB-10	1-3/4	3-1/2	JIC-1543266C1	50.06
RIPPER	G101214			P-UB-10	1-3/4	3-1/4	JIC-1543265C1	50.29
	G101215			P-UB-10	1-3/4	3-1/4	JIC-1543265C1	50.29
TILT	117511A1			P-UB-10	1-3/4	3-1/2	JIC-1543266C1	50.06
<b>MODEL 650K</b>								
ANGLE	412359A1		11/02-	P-UB-10	1-3/4	3-1/2	JIC-250741A1	64.23
LIFT	417854A1		11/02-	P-UB-10	1-3/4	3-1/2	JIC-1543266C1	50.06
RIPPER LH	86994131		11/02-	N-UB-1	1-3/4		JIC-1542875C1	17.66
RIPPER RH	86994129		11/02-	P-UB-10	1-3/4	3-1/2	JIC-1543266C1	50.06
TILT	412357A1		11/02-	P-UB-10	1-3/4	3-1/2	JIC-1543266C1	50.06
<b>MODEL 750 with Backhoe Models 32, 33S, 34</b>								
BACKHOE BOOM		2pc		P-U-9	2	4	JIC-G32299	51.90
		2pc		P-UB-9	2-1/4	4-1/2	JIC-G105520	88.28
				I-U-1	2		JIC-D42876	19.32
				P-U-1	2-1/4		JIC-D42878	18.66
		2pc		N-N-9		4	JIC-G33239	25.19
		2pc		N-N-9		4-1/2	JIC-DTVS4.5P	51.78
BACKHOE BUCKET		2pc		P-U-9	2	3-1/2	JIC-G32293	40.26
				I-U-1	2-1/4		JIC-D42877	15.20
				I-U-1	2		JIC-D42874	16.35
				P-U-1	1-3/4		JIC-D42873	21.01
		2pc		N-N-9		3-1/2	JIC-G33237	23.09
		2pc		N-N-9		4	JIC-G33239	25.19
BACKHOE DIPPER		2pc		P-U-9	2	4	JIC-G32299	51.90
				I-U-1	2		JIC-D42876	19.32
				P-U-1	2-1/4		JIC-D42878	18.66
		2pc		N-N-9		4-1/2	JIC-DTVS4.5P	51.78
		2pc		N-N-9		4	JIC-G33239	25.19
		2pc		P-UB-9	1-3/4	3-1/2	JIC-G105529	41.78
BACKHOE STABILIZER				P-U-1	1-3/4		JIC-D42873	21.01
		2pc		N-N-9		3-1/2	JIC-G33237	23.09
		2pc		P-UB-9	1-3/4	4	JIC-G105519	49.76
BACKHOE SWING				P-U-1	1-3/4		JIC-D42875	16.26
		2pc		N-N-9		4	JIC-G33239	25.19
	DOZER ANGLE			I-U-9	1-1/2	2-1/2	JIC-D37360	40.91



# CASE

Replacement Kits For

Crawler Dozers/Loaders								
APPLICATION	CYL #	Piston	SERIAL #	CODE	ROD	BORE	KIT #	List \$
<b>MODEL 750 with Backhoe Models 32, 33S, 34</b>								
DOZER TILT				P-U-1	1-3/4		JIC-D42873	21.01
		2pc		N-N-9		3-1/2	JIC-G33237	23.09
LOADER LIFT				P-U-1	1-1/2		JIC-D42870	20.47
		2pc		N-N-9		3	JIC-G33151	20.85
LOADER TILT				I-U-1	2		JIC-D42876	19.32
		2pc		N-N-9		4	JIC-G33239	25.19
RIPPER				P-U-1	1-3/4		JIC-D42873	21.01
		2pc		N-N-9		3-1/2	JIC-G33237	23.09
<b>MODEL 750H</b>								
ANGLE	190595A1			P-UB-10	1-3/4	3-1/2	JIC-1543266C1	50.06
	190595A2			P-UB-10	1-3/4	3-1/2	JIC-250741A1	64.23
LIFT	116211A2			P-UB-10	1-3/4	3-1/2	JIC-1543266C1	50.06
RIPPER	G101214			P-UB-10	1-3/4	3-1/4	JIC-1543265C1	50.29
	G101215			P-UB-10	1-3/4	3-1/4	JIC-1543265C1	50.29
TILT	117511A2			P-UB-10	1-3/4	3-1/2	JIC-1543266C1	50.06
<b>MODEL 850 with Backhoe Models 34, 35, 36</b>								
BACKHOE BOOM		2pc		P-UB-9	1-3/4	3-1/4	JIC-G105528	47.83
		1pc		P-UB-10	1-3/4	3-1/4	JIC-G105547	44.90
		2pc		P-U-9	2-1/4	5	JIC-G32696	75.24
				P-U-1	2-1/4		JIC-D42878	18.66
		2pc		N-N-9		4-1/2	JIC-DTVS4.5P	51.78
BACKHOE BUCKET		2pc		P-UB-9	2-1/4	4	JIC-G34636	59.90
		1pc		P-UB-10	2	3-1/2	JIC-G105546	46.94
		2pc		P-UB-9	2	3-1/2	JIC-G105527	52.45
				I-U-1	2-1/4		JIC-D42877	15.20
		2pc		N-N-9		4	JIC-G33239	25.19
BACKHOE DIPPER		1pc		P-UB-10	2	4	JIC-1543273C1	64.28
		2pc		P-UB-9	2-1/2	4-1/2	JIC-G105513	91.03
		2pc		P-UB-9	2-1/4	4-1/2	JIC-G105520	88.28
		2pc		P-UB-9	2	4	JIC-G105517	54.98
				P-U-1	2-1/4		JIC-D42878	18.66
		2pc		N-N-9		4-1/2	JIC-DTVS4.5P	51.78
BACKHOE DIPPER EXT		2pc		P-UB-9	1-1/2	3	JIC-G105512	52.15
		1pc		P-UB-10	1-1/2	3	JIC-G105548	39.05
BACKHOE STABILIZER		1pc		P-UB-10	2	4	JIC-1543273C1	64.28
		2pc		P-UB-9	2	4	JIC-G105517	54.98
		2pc		P-U-9	2	4	JIC-G32299	51.90
				I-U-1	2		JIC-D42876	19.32
		2pc		N-N-9		4	JIC-G33239	25.19
BACKHOE SWING		2pc		P-UB-9	2	4	JIC-G105517	54.98
		2pc		P-UB-9	2	4-1/2	JIC-G105525	73.53
		2pc		P-U-9	2	4-1/2	JIC-G32695	75.71
		1pc		P-UB-10	2	4	JIC-1543273C1	64.28
				P-U-1	1-3/4		JIC-D42875	16.26
		2pc		N-N-9		4	JIC-G33239	25.19
DOZER ANGLING		2pc		P-UB-9	1-1/2	2-1/2	JIC-G105505	35.33
		2pc		I-U-9	1-1/2	2-1/2	JIC-D37360	40.91
DOZER LIFT		2pc		P-UB-9	1-1/2	3	JIC-G105512	52.15
				P-U-1	1-1/2		JIC-D42870	20.47
		2pc		N-N-9		3	JIC-G33151	20.85
DOZER TILT		2pc		P-U-9	1-3/4	3-1/2	JIC-G105518	44.55
				P-U-1	1-3/4		JIC-D42873	21.01
		2pc		N-N-9		3-1/2	JIC-G33237	23.09
DOZER TILT & PITCH		2pc		P-UB-9	2	3-1/2	JIC-G105521	45.75
LOADER CLAM		2pc		P-U-9	2	4	JIC-G32299	51.90

CASE



# CASE

Replacement Kits For

<b>Crawler Dozers/Loaders</b>								
<b>APPLICATION</b>	<b>CYL #</b>	<b>Piston</b>	<b>SERIAL #</b>	<b>CODE</b>	<b>ROD</b>	<b>BORE</b>	<b>KIT #</b>	<b>List \$</b>
<b>MODEL 850 with Backhoe Models 34, 35, 36</b>								
LOADER HYDRA-LEVELING		2pc		P-UB-9	2	4	JIC-G105517	54.98
		2pc		P-U-9	2	4	JIC-G32299	51.90
				I-U-1	2		JIC-D42876	19.32
		2pc		N-N-9		4	JIC-G33239	25.19
LOADER LIFT				P-UB-9	2-1/4	4-1/2	JIC-G105520	88.28
				P-U-1	2-1/4		JIC-D42878	18.66
		2pc		N-N-9		4-1/2	JIC-DTVS4.5P	51.78
LOADER TILT		2pc		P-U-9	1-3/4	3-1/2	JIC-G105508	48.49
		2pc		P-U-9	1-3/4	3-1/2	JIC-G32228	39.76
				P-U-1	1-3/4		JIC-D42873	21.01
		2pc		N-N-9		3-1/2	JIC-G33237	23.09
RIPPER		2pc		P-U-9	1-3/4	4	JIC-G34626	53.90
				P-U-1	1-3/4		JIC-D42875	16.26
		2pc		N-N-9		4	JIC-G33239	25.19
<b>MODEL 850B with Backhoe Model 35</b>								
BACKHOE BOOM		1pc		P-UB-10	1-3/4	3-1/4	JIC-G105547	44.90
		2pc		P-UB-9	1-3/4	3-1/4	JIC-G105528	47.83
BACKHOE BUCKET		2pc		P-UB-9	2	3-1/2	JIC-G105527	52.45
		1pc		P-UB-10	2	3-1/2	JIC-G105546	46.94
BACKHOE DIPPER		1pc		P-UB-10	2	4	JIC-1543273C1	64.28
		2pc		P-UB-9	2	4	JIC-G105517	54.98
BACKHOE DIPPER EXT		1pc		P-UB-10	1-1/2	3	JIC-G105548	39.05
		2pc		P-UB-9	1-1/2	3	JIC-G105512	52.15
BACKHOE STABILIZER		1pc		P-UB-10	2	4	JIC-1543273C1	64.28
		2pc		P-UB-9	2	4	JIC-G105517	54.98
BACKHOE SWING		1pc		P-UB-10	2	4	JIC-1543273C1	64.28
		2pc		P-UB-9	2	4	JIC-G105517	54.98
DOZER ANGLE		2pc		P-UB-9	2	4-1/2	JIC-G105525	73.53
DOZER LIFT		1pc		P-UB-10	1-1/2	3	JIC-G105548	39.05
		1pc		P-UB-10	1-3/4	3	JIC-G105549	49.69
DOZER TILT		1pc		P-UB-10	2	4	JIC-1543273C1	64.28
		1pc		P-UB-10	1-3/4	4	JIC-G105552	46.78
LOADER CLAM		1pc		P-UB-10	2	3-1/2	JIC-G105546	46.94
LOADER LIFT		1pc		P-UB-10	2	4	JIC-1543273C1	64.28
LOADER TILT		1pc		P-UB-10	2	3-1/2	JIC-G105546	46.94
RIPPER		1pc		P-UB-10	1-3/4	3-1/4	JIC-G105547	44.90
<b>MODEL 850C, 855C with Backhoe Models 35A, 35C, 35C WL, 35 WL</b>								
BACKHOE BOOM		1pc		P-UB-10	1-3/4	3-1/4	JIC-G105547	44.90
BACKHOE BUCKET		1pc		P-UB-10	2-1/2	4	JIC-G109424	51.32
		1pc		P-UB-10	2-1/2	3-1/2	JIC-G109504	43.39
		1pc		P-UB-10	2	3-1/2	JIC-G105546	46.94
BACKHOE DIPPER		1pc		P-UB-10	2	4	JIC-1543273C1	64.28
BACKHOE DIPPER EXT		1pc		P-UB-10	1-1/2	3	JIC-G105548	39.05
BACKHOE STABILIZER		1pc		P-UB-10	2	4	JIC-1543273C1	64.28
BACKHOE SWING		1pc		P-UB-10	2	4	JIC-1543273C1	64.28
DOZER ANGLE		2pc		P-UB-9	2	4-1/2	JIC-G105525	73.53
DOZER LIFT		1pc		P-UB-10	1-1/2	3	JIC-G105548	39.05
		1pc		P-UB-10	1-3/4	3	JIC-G105549	49.69
DOZER TILT		1pc		P-UB-10	2	4	JIC-1543273C1	64.28
				P-UB-10	1-3/4	4	JIC-G105552	46.78
LOADER CLAM		1pc		P-UB-10	2	3-1/2	JIC-G105546	46.94
LOADER LIFT		1pc		P-UB-10	2	4	JIC-1543273C1	64.28
LOADER TILT		1pc		P-UB-10	2	3-1/2	JIC-G105546	46.94
RIPPER		1pc		P-UB-10	1-3/4	3-1/4	JIC-G105547	44.90





# CASE

Replacement Kits For

Crawler Dozers/Loaders								
APPLICATION	CYL #	Piston	SERIAL #	CODE	ROD	BORE	KIT #	List \$
<b>MODEL 850D with Backhoe Models 35C, 35C WL</b>								
BACKHOE BOOM		1pc		P-UB-10	1-3/4	3-1/4	JIC-1543265C1	50.29
BACKHOE BUCKET		1pc		P-UB-10	2-1/2	3-1/2	JIC-G109504	43.39
		1pc		P-UB-10	2-1/2	4	JIC-G109424	51.32
BACKHOE DIPPER		1pc		P-UB-10	2	4	JIC-1543273C1	64.28
BACKHOE DIPPER EXT		1pc		P-UB-10	1-1/2	3	JIC-G109452	29.65
BACKHOE STABILIZER		1pc		P-UB-10	2	4	JIC-1543273C1	64.28
BACKHOE SWING		1pc		P-UB-10	2	4	JIC-1543273C1	64.28
DOZER LIFT		1pc		P-UB-10	1-1/2	3	JIC-G109452	29.65
DOZER TILT		1pc		P-UB-10	2	4	JIC-1543273C1	64.28
LOADER CLAM		1pc		P-UB-10	2	3-1/2	JIC-G109453	43.95
LOADER LIFT		1pc		P-UB-10	2	4	JIC-1543273C1	64.28
LOADER TILT		1pc		P-UB-10	2	3-1/2	JIC-G109453	43.95
RIPPER		1pc		P-UB-10	1-3/4	3-1/4	JIC-1543265C1	50.29
<b>MODEL 850E, 855E</b>								
DOZER ANGLE	1542644C1			P-UB-10	2	4	JIC-1543273C1	64.28
	G103467			P-UB-9	2	4-1/2	JIC-1543270C1	93.22
DOZER LIFT	G101217			P-UB-10	1-1/2	3	JIC-1543252C1	42.22
DOZER TILT	G109485			P-UB-10	2	4	JIC-1543273C1	64.28
LOADER BUCKET	G101210			P-UB-10	2	3-1/2	JIC-1543274C1	65.64
LOADER CLAM	G101211			P-UB-10	2	3-1/2	JIC-1543274C1	65.64
LOADER LIFT L/H	G101213			P-UB-10	2	4	JIC-1543273C1	64.28
LOADER LIFT R/H	G101212			P-UB-10	2	4	JIC-1543273C1	64.28
RIPPER L/H	G101215			P-UB-10	1-3/4	3-1/4	JIC-1543265C1	50.29
RIPPER R/H	G101214			P-UB-10	1-3/4	3-1/4	JIC-1543265C1	50.29
<b>MODEL 850G</b>								
ANGLE	116969A1			P-UB-10	1-3/4	3-1/2	JIC-1543266C1	50.06
	190595A1			P-UB-10	1-3/4	3-1/2	JIC-1543266C1	50.06
LIFT	116211A1			P-UB-10	1-3/4	3-1/2	JIC-1543266C1	50.06
RIPPER L/H	G101215			P-UB-10	1-3/4	3-1/4	JIC-1543265C1	50.29
RIPPER R/H	G101214			P-UB-10	1-3/4	3-1/4	JIC-1543265C1	50.29
TILT	117511A1			P-UB-10	1-3/4	3-1/2	JIC-1543266C1	50.06
<b>MODEL 850H</b>								
ANGLE	190595A2			P-UB-10	1-3/4	3-1/2	JIC-250741A1	64.23
LIFT	116211A2			P-UB-10	1-3/4	3-1/2	JIC-1543266C1	50.06
RIPPER LH	G101215			P-UB-10	1-3/4	3-1/4	JIC-1543265C1	50.29
RIPPER RH	G101214			P-UB-10	1-3/4	3-1/4	JIC-1543265C1	50.29
TILT	117511A2			P-UB-10	1-3/4	3-1/2	JIC-1543266C1	50.06
<b>MODEL 850K</b>								
ANGLE	412359A1		11/02-	P-UB-10	1-3/4	3-1/2	JIC-250741A1	64.23
LIFT	417854A1		11/02-	P-UB-10	1-3/4	3-1/2	JIC-1543266C1	50.06
RIPPER LH	86994131		11/02-	P-UB-10	1-3/4	3-1/4	JIC-1543265C1	50.29
RIPPER RH	86994129		11/02-	P-UB-10	1-3/4	3-1/4	JIC-1543265C1	50.29
TILT	412357A1		11/02-	P-UB-10	1-3/4	3-1/2	JIC-1543266C1	50.06
<b>MODEL 1150 with Backhoe Models 32, 34, 36</b>								
BACKHOE BOOM		2pc		P-U-9	2-1/4	5	JIC-G32696	75.24
				I-U-1	2		JIC-D42876	19.32
				P-U-1	2-1/4		JIC-D42878	18.66
		2pc		N-N-9		4-1/2	JIC-DTVS4.5P	51.78
		2pc		N-N-9		4	JIC-G33239	25.19
BACKHOE BUCKET		2pc		P-UB-9	2-1/4	4	JIC-G34636	59.90
				I-U-1	2-1/4		JIC-D42877	15.20
				P-U-1	1-3/4		JIC-D42873	21.01
		2pc		N-N-9		4	JIC-G33239	25.19
		2pc		N-N-9		3-1/2	JIC-G33237	23.09
BACKHOE DIPPER		2pc		P-UB-9	2-1/4	4-1/2	JIC-G105520	88.28
		2pc		P-UB-9	2-1/2	4-1/2	JIC-G105513	91.03

CASE



# CASE

Replacement Kits For

<b>Crawler Dozers/Loaders</b>								
APPLICATION	CYL #	Piston	SERIAL #	CODE	ROD	BORE	KIT #	List \$
<b>MODEL 1150 with Backhoe Models 32, 34, 36</b>								
BACKHOE DIPPER				I-U-1	2		JIC-D42876	19.32
				P-U-1	2-1/4		JIC-D42878	18.66
		2pc		N-N-9		4	JIC-G33239	25.19
		2pc		N-N-9		4-1/2	JIC-DTVS4.5P	51.78
BACKHOE STABILIZER		2pc		P-UB-9	2	4	JIC-G105517	54.98
		2pc		P-U-9	2	4	JIC-G32299	51.90
				P-U-1	1-3/4		JIC-D42873	21.01
				I-U-1	2		JIC-D42876	19.32
		2pc		N-N-9		3-1/2	JIC-G33237	23.09
		2pc		N-N-9		4	JIC-G33239	25.19
BACKHOE SWING		2pc		P-U-9	2	4-1/2	JIC-G32695	75.71
		2pc		P-UB-9	2	4-1/2	JIC-G105525	73.53
				P-U-1	1-3/4		JIC-D42875	16.26
		2pc		N-N-9		4	JIC-G33239	25.19
DOZER LIFT		2pc		P-U-9	1-3/4	3-1/2	JIC-G105518	44.55
		2pc		P-U-9	1-3/4	3-1/2	JIC-G105508	48.49
		2pc		P-UB-9	1-3/4	3-1/2	JIC-G105529	41.78
				P-U-1	1-3/4		JIC-D42873	21.01
		2pc		N-N-9		3-1/2	JIC-G33237	23.09
	DOZER TILT		2pc		P-U-9	1-3/4	3-1/2	JIC-G105518
				P-U-1	1-3/4		JIC-D42873	21.01
		2pc		N-N-9		3-1/2	JIC-G33237	23.09
LOADER CLAM			2pc		P-U-9	2	4	JIC-G32299
		2pc		P-UB-9	2-1/4	4-1/2	JIC-G105520	88.28
				I-U-1	2		JIC-D42876	19.32
		2pc		N-N-9		4	JIC-G33239	25.19
LOADER LIFT		2pc		P-U-9	2-1/2	5-1/2	JIC-G33823	81.96
LOADER TILT		2pc		P-U-9	2-1/4	5	JIC-G32696	75.24
PIPPER		2pc		P-UB-9	2	4	JIC-G105526	54.90
		2pc		P-UB-9	2	4	JIC-G105517	54.98
				I-U-1	2		JIC-D42876	19.32
		2pc		N-N-9		4	JIC-G33239	25.19
<b>MODEL 1150B</b>								
DOZER ANGLE		2pc		P-UB-9	1-3/4	3	JIC-G105523	49.91
		1pc		P-UB-10	1-3/4	3	JIC-G105549	49.69
		2pc		P-U-9	1-3/4	3	JIC-G34643	45.91
DOZER TILT		2pc		P-UB-9	2-1/4	4-1/2	JIC-G105520	88.28
DOZER TILT & PITCH		1pc		P-UB-10	2-1/4	4	JIC-G105556	50.75
		2pc		P-UB-9	2-1/4	4	JIC-G34636	59.90
FELLER BUNCHER		2pc		P-UB-9	2-1/4	4-1/2	JIC-G105520	88.28
LOADER CLAM		2pc		P-UB-9	2-1/4	4-1/2	JIC-G105520	88.28
LOADER LIFT		2pc		P-UB-9	2-1/4	5	JIC-G105530	91.91
		2pc		P-U-9	2-1/4	5	JIC-G32696	75.24
LOADER TILT		2pc		P-UB-9	2-1/4	4-1/2	JIC-G105520	88.28
RIPPER		2pc		P-UB-9	2	4	JIC-G105526	54.90
		1pc		P-UB-10	2	4	JIC-1543273C1	64.28
<b>MODEL 1150C, 1150D, 1155D</b>								
DOZER ANGLE		1pc		P-UB-10	1-3/4	3	JIC-1543262C1	40.59
DOZER LIFT		1pc		P-UB-10	1-3/4	3-1/2	JIC-G109471	42.84
DOZER TILT		2pc		P-UB-9	2-1/4	4-1/2	JIC-G105520	88.28
DOZER TILT & PITCH		1pc		P-UB-10	2-1/4	4	JIC-G109505	46.61
LOADER CLAM		2pc		P-UB-9	2-1/4	4-1/2	JIC-G105520	88.28
LOADER LIFT		2pc		P-UB-9	2-1/4	5	JIC-G109501	85.03
LOADER TILT		2pc		P-UB-9	2-1/4	4-1/2	JIC-G105520	88.28
RIPPER		1pc		P-UB-10	2	4	JIC-1543273C1	64.28



# CASE

Replacement Kits For

<b>Crawler Dozers/Loaders</b>								
APPLICATION	CYL #	Piston	SERIAL #	CODE	ROD	BORE	KIT #	List \$
<b>MODEL 1150G</b>								
ANGLE	G110702			P-UB-10	2-1/2	5	JIC-1542915C2	59.99
LIFT	G109819			P-UB-10	1-3/4	3-1/4	JIC-1543265C1	50.29
RIPPER	G101272			P-UB-10	2	4	JIC-1543273C1	64.28
	G101273			P-UB-10	2	4	JIC-1543273C1	64.28
TILT	G110694			P-UB-10	2-1/2	5	JIC-1542915C2	59.99
<b>MODEL 1150H</b>								
ANGLE	G110702			P-UB-10	2-1/2	5	JIC-1542915C2	59.99
LIFT	G109819			P-UB-10	1-3/4	3-1/4	JIC-1543265C1	50.29
RIPPER LH	G101273			P-UB-10	2	4	JIC-1543273C1	64.28
RIPPER RH	G101272			P-UB-10	2	4	JIC-1543273C1	64.28
TILT	G110694			P-UB-10	2-1/2	5	JIC-1542879C1	62.19
<b>MODEL 1450</b>								
DOZER ANGLE		1pc		P-UB-10	2	4	JIC-1543273C1	64.28
DOZER LIFT		2pc		P-UB-9	2	4	JIC-G105517	54.98
		1pc		P-UB-10	2	4	JIC-1543273C1	64.28
DOZER TILT		2pc		P-UB-9	3	6	JIC-G105516	95.29
DOZER TILT & PITCH		2pc		P-UB-9	2-1/2	5	JIC-G105515	77.48
LOADER CLAM		2pc		P-UB-9	2-1/4	4-1/2	JIC-G105520	88.28
LOADER LIFT		2pc		P-UB-9	2-1/2	5-1/2	JIC-G105514	91.25
LOADER TILT		2pc		P-UB-9	2-1/2	5	JIC-G105515	77.48
RIPPER		1pc		P-UB-10	2	4	JIC-1543273C1	64.28
		2pc		P-UB-9	2	4	JIC-G105526	54.90
<b>MODEL 1450B, 1455B</b>								
DOZER ANGLE		1pc		P-UB-10	2-1/4	4	JIC-G105556	50.75
DOZER LIFT		1pc		P-UB-10	2	4	JIC-1543273C1	64.28
DOZER TILT		2pc		P-UB-9	3	6	JIC-G105516	95.29
DOZER TILT & PITCH		2pc		P-UB-9	2-1/2	5	JIC-G105515	77.48
LOADER CLAM		2pc		P-UB-9	2-1/4	4-1/2	JIC-G105520	88.28
LOADER LIFT		2pc		P-UB-9	2-1/2	5-1/2	JIC-G105514	91.25
LOADER TILT		2pc		P-UB-9	2-1/2	5	JIC-G105515	77.48
RIPPER		1pc		P-UB-10	2	4	JIC-1543273C1	64.28
<b>Excavators</b>								
APPLICATION	CYL #	Piston	SERIAL #	CODE	ROD	BORE	KIT #	List \$
<b>MODEL 880</b>								
ARM		2pc	6200000-6201114	P-UB-9	2-1/2	5-1/2	JIC-G105514	91.25
		2pc	6201115-	P-UB-9	2-3/4	5-1/2	JIC-G105566	147.29
BOOM		2pc	6200000-6201114	P-UB-9	2-1/2	5-1/2	JIC-G105514	91.25
		2pc	6201115-	P-UB-9	2-3/4	5-1/2	JIC-G105566	147.29
BUCKET		2pc		P-UB-9	2-1/2	5	JIC-G105515	77.48
EXT BUCKET		2pc		P-UB-9	3	5	JIC-G105531	88.67
EXT DIPPER		2pc		P-UB-9	2-1/4	4	JIC-G34636	59.90
		1pc		P-UB-10	2-1/4	4	JIC-G105556	50.75
<b>MODEL 880B, 880C, 880D</b>								
ARM		2pc		P-UB-9	2-3/4	5-1/2	JIC-G105566	147.29
BOOM		2pc		P-UB-9	2-3/4	5-1/2	JIC-G105566	147.29
BUCKET		2pc		P-UB-9	2-1/2	5	JIC-G109499	102.13
<b>MODEL 880R</b>								
ARM		2pc		P-UB-9	2-3/4	5-1/2	JIC-G105566	147.29
BOOM		2pc		P-UB-9	2-3/4	5-1/2	JIC-G105566	147.29
EXT BUCKET		2pc		P-UB-9	3	5	JIC-G105531	88.67
EXT DIPPER		2pc	-5352380	P-UB-9	2-1/4	4	JIC-G34636	59.90
		1pc	5352381-	P-UB-10	2-1/4	4	JIC-G105556	50.75
<b>MODEL 9010B</b>								
ARM		1pc		P-UB-10	80 mm	115 mm	JIC-164494A1	279.56
BOOM		1pc		P-UB-10	75 mm	100 mm	JIC-164493A1	174.78
BUCKET		1pc		P-UB-10	70 mm	95 mm	JIC-162976A1	244.54

CASE



# CASE

Replacement Kits For

Excavators								
APPLICATION	CYL #	Piston	SERIAL #	CODE	ROD	BORE	KIT #	List \$
<b>MODEL 9020B</b>								
ARM		1pc		P-UB-10	90 mm	125 mm	JIC-161913A1	316.86
BOOM		1pc		P-UB-10	80 mm	115 mm	JIC-161912A1	265.30
BUCKET		1pc		P-UB-10	75 mm	105 mm	JIC-161914A1	278.53
<b>MODEL 9030B</b>								
ARM (Long Reach)		1pc		P-UB-10	105 mm	150 mm	JIC-160227A1	374.11
ARM (w/o long reach)		1pc		P-UB-10	100 mm	135 mm	JIC-160579A1	359.26
BOOM (w/ load option)		1pc		P-UB-10	85 mm	125 mm	JIC-164183A1	250.64
BOOM (w/o load option)		1pc		P-UB-10	85 mm	125 mm	JIC-160577A1	253.28
BUCKET (Long Reach)		1pc		P-UB-10	70 mm	95 mm	JIC-162976A1	244.54
BUCKET (w/o long reach)		1pc		P-UB-10	80 mm	120 mm	JIC-160581A1	233.91
<b>MODEL 9040B</b>								
ARM	151155A1			P-UB-10	110 mm	160 mm	JIC-156002A1	462.37
	159453A1			P-UB-10	105 mm	150 mm	JIC-160227A1	374.11
	162816			P-UB-10	105 mm	150 mm	JIC-160227A1	374.11
BOOM	159462A1			P-UB-10	90 mm	130 mm	JIC-LZ00533	484.06
	159463A1			P-UB-10	90 mm	130 mm	JIC-LZ00533	484.06
	162815A1			P-UB-10	90 mm	130 mm	JIC-LZ00533	484.06
BUCKET	159452A1			P-UB-10	90 mm	135 mm	JIC-160229A1	273.04
	160752A1			P-UB-10	70 mm	95 mm	JIC-LZ00522	244.54
<b>MODEL CX130</b>								
ARM	KNV1617			P-UB-10	80 mm	115 mm	JIC-LZ00449	108.69
	KNV1621			P-UB-10	80 mm	115 mm	JIC-LZ00449	108.69
BOOM LH	KNV1616			P-UB-10	70 mm	105 mm	JIC-LZ00448	119.45
	KNV1620			P-UB-10	70 mm	105 mm	JIC-LZ00448	119.45
BOOM RH	KNV1615			P-UB-10	70 mm	105 mm	JIC-LZ00448	119.45
	KNV1619			P-UB-10	70 mm	105 mm	JIC-LZ00448	119.45
BUCKET	KNV1618			P-UB-10	65 mm	95 mm	JIC-LZ00450	77.73
DOZER BLADE LH	168637A1			P-UB-10	70 mm	100 mm	JIC-LQU0245	129.64
DOZER BLADE RH	168636A1			P-UB-10	70 mm	100 mm	JIC-LQU0245	129.64
<b>MODEL CX135SR</b>								
ARM (w/ Load Hold)	KMV2548		08/02-	P-UB-10	80 mm	115 mm	JIC-LZ00449	108.69
ARM (w/o Load Hold)	KNV1617		08/02-	P-UB-10	80 mm	115 mm	JIC-LZ00449	108.69
BOOM LH (w/ Load Hold)	KMV2547		08/02-	P-UB-10	75 mm	105 mm	JIC-LZ00453	112.89
BOOM LH (w/o Load Hold)	KMV2543		08/02-	P-UB-10	75 mm	105 mm	JIC-LZ00453	112.89
BOOM RH (w/ Load Hold)	KMV2546		08/02-	P-UB-10	75 mm	105 mm	JIC-LZ00453	112.89
BOOM RH (w/o Load Hold)	KMV2542		08/02-	P-UB-10	75 mm	105 mm	JIC-LZ00453	112.89
BUCKET	KMV2545		08/02-	P-UB-10	65 mm	95 mm	JIC-LZ00450	77.73
DOZER BLADE LH (w/ Load Hold)	KMV2554		08/02-	P-UB-10	70 mm	110 mm	JIC-LZ00457	73.36
DOZER BLADE LH (w/o Load Hold)	KMV2368		08/02-	P-UB-10	70 mm	110 mm	JIC-LZ00457	73.36
DOZER BLADE RH (w/ Load Hold)	KMV2553		08/02-	P-UB-10	70 mm	110 mm	JIC-LZ00457	73.36
DOZER BLADE RH (w/o Load Hold)	KMV2367		08/02-	P-UB-10	70 mm	110 mm	JIC-LZ00457	73.36
OFFSET ARM	KMV2551		08/02-	P-UB-10	75 mm	105 mm	JIC-LZ00455	140.26
OFFSET BOOM	KMV2552		08/02-	P-UB-10	65 mm	120 mm	JIC-LZ00456	69.42
<b>MODEL CX160</b>								
ARM (w/o Load Hold)	KLW0308			P-UB-10	90 mm	125 mm	JIC-LZ00452	185.20
ARM (w/ Load Hold)	KLW0353			P-UB-10	90 mm	125 mm	JIC-LZ00452	185.20
BOOM LH ( w/ Load Hold)	KLW0352			I-UB-10	80 mm	115 mm	JIC-LZ00451	112.93
BOOM LH ( w/o Load Hold)	KLW0306			I-UB-10	80 mm	115 mm	JIC-LZ00451	112.93
BOOM RH (w/ Load Hold)	KLW0351			I-UB-10	80 mm	115 mm	JIC-LZ00451	112.93
BOOM RH (w/o Load Hold)	KLW0307			I-UB-10	80 mm	115 mm	JIC-LZ00451	112.93
BUCKET	KLW0309			P-UB-10	75 mm	105 mm	JIC-LZ00453	112.89



# CASE

Replacement Kits For

<b>Excavators</b>								
APPLICATION	CYL #	Piston	SERIAL #	CODE	ROD	BORE	KIT #	List \$
<b>MODEL CX210</b>								
ARM (w/ Load Hold)	KRV3239			P-UB-10	95 mm	135 mm	JIC-LZ00446	115.70
ARM (w/o Load Hold)	KRV3236			P-UB-10	95 mm	135 mm	JIC-LZ00446	115.70
BOOM (w/ Load Hold)	KRV18920			P-UB-10	85 mm	120 mm	JIC-LZ00445	134.46
BOOM LH	KRV18910			P-UB-10	85 mm	120 mm	JIC-LZ00445	134.46
BOOM RH	KRV18900			P-UB-10	85 mm	120 mm	JIC-LZ00445	134.46
BUCKET	KRV3237			P-UB-10	80 mm	115 mm	JIC-LZ00447	92.83
<b>MODEL CX240</b>								
ARM (w/ Load Hold)	KBV1687			P-UB-10	105 mm	145 mm	JIC-LZ00443	138.66
ARM (w/o Load Hold)	KBV1789			P-UB-10	105 mm	145 mm	JIC-LZ00443	138.66
BOOM (w/ Load Hold)	KBV1686			P-UB-10	90 mm	125 mm	JIC-LZ00442	155.85
BOOM LH (w/o Load Hold)	KBV1788			P-UB-10	90 mm	125 mm	JIC-LZ00442	155.85
BOOM RH (w/o Load Hold)	KBV1787			P-UB-10	90 mm	125 mm	JIC-LZ00442	155.85
BUCKET	KBV1790			P-UB-10	90 mm	130 mm	JIC-LZ00444	150.19
<b>MODEL CX330</b>								
ARM (w/ Load Hold)	KSV1456			P-UB-10	120 mm	170 mm	JIC-LZ00478	347.03
ARM (w/o Load Hold)	KSV1395			P-UB-10	120 mm	170 mm	JIC-LZ00478	347.03
BOOM LH (w/ Load Hold)	KSV1455			P-UB-10	100 mm	145 mm	JIC-LZ00477	299.20
BOOM LH (w/o Load Hold)	KSV1394			P-UB-10	100 mm	145 mm	JIC-LZ00477	299.20
BOOM RH (w/ Load Hold)	KSV1454			P-UB-10	100 mm	145 mm	JIC-LZ00477	299.20
BOOM RH (w/o Load Hold)	KSV1393			P-UB-10	100 mm	145 mm	JIC-LZ00477	299.20
BUCKET	KSV1396			P-UB-10	105 mm	150 mm	JIC-LZ00476	406.61
<b>Loaders - Skid Steer</b>								
APPLICATION	CYL #	Piston	SERIAL #	CODE	ROD	BORE	KIT #	List \$
<b>MODEL 40XT</b>								
BACKHOE BOOM D100	G100936			P-UB-10	1-1/2	3	JIC-1543252C1	42.22
BACKHOE BOOM D125	305352A1			P-UB-10	1-1/2	3	JIC-1543256C1	39.76
BACKHOE BUCKET D100	G100936			P-UB-10	1-1/2	3	JIC-1543252C1	42.22
BACKHOE DIPPER D100	G100936			P-UB-10	1-1/2	3	JIC-1543252C1	42.22
BACKHOE DIPPER D125	1346411C3			P-UB-10	1-1/2	3	JIC-1543256C1	39.76
LIFT	87438185			P-UB-11	1-1/2	2-1/4	JIC-86613644	32.30
LOADER BUCKET	447169A1		JAF0374550- NA, JAF0348069- EU	P-U-10	35 mm	65 mm	JIC-86988481	39.36
LOADER LIFT	447170A1		JAF0374550- NA, JAF0348069- EU	P-U-10	40 mm	60 mm	JIC-86988474	34.53
	86614636		-JAF0374549 NA, - JAF0348068 EU	P-UB-11	1-1/2	2-1/4	JIC-86613644	32.30
STABILIZER Vertical	H514117			P-U-10	1	2	JIC-H52704	16.09
<b>MODEL 60XT</b>								
BACKHOE BOOM D100	G100936			P-UB-10	1-1/2	3	JIC-1543252C1	42.22
BACKHOE BOOM D125	305352A1			P-UB-10	1-1/2	3	JIC-1543256C1	39.76
BACKHOE BUCKET D100	G100936			P-UB-10	1-1/2	3	JIC-1543252C1	42.22
BACKHOE DIPPER D100	G100936			P-UB-10	1-1/2	3	JIC-1543252C1	42.22
BACKHOE DIPPER D125	1346411C3			P-UB-10	1-1/2	3	JIC-1543256C1	39.76
LOADER BUCKET	447171A1		JAF0350357- NA, JAF0350744- EU	P-U-10	35 mm	70 mm	JIC-86988490	50.74
	86614637		-JAF0350356 NA, - JAF0350743 EU	P-UB-11	1-3/8	2-3/4	JIC-86613643	47.48
LOADER LIFT	447173A1		JAF0350357- NA, JAF0350744- EU	P-U-10	40 mm	65 mm	JIC-86988486	31.01
	86614638		-JAF0350356 NA, - JAF0350743 EU	P-UB-11	1-1/2	2-1/2	JIC-86631598	32.48
STABILIZER Vertical	H514117			P-U-10	1	2	JIC-H52704	16.09
TILT	87438187			P-UB-11	1-3/8	2-3/4	JIC-86613643	47.48
	87438193			P-U-11	1-1/2	3	JIC-86614269	32.31
<b>MODEL 70XT</b>								
BACKHOE BOOM	305352A1			P-UB-10	1-1/2	3	JIC-1543256C1	39.76
BACKHOE DIPPER	1346411C3			P-UB-10	1-1/2	3	JIC-1543256C1	39.76

CASE



# CASE

Replacement Kits For

Loaders - Skid Steer								
APPLICATION	CYL #	Piston	SERIAL #	CODE	ROD	BORE	KIT #	List \$
<b>MODEL 70XT</b>								
LIFT	87438190			P-UB-11	1-1/2	2-1/2	JIC-86631598	32.48
LOADER BUCKET	447172A1		JAF0371244- NA, JAF0351855- EU	P-U-10	35 mm	75 mm	JIC-86988494	47.58
	86614639		-JAF0371243 NA, - JAF0351854 EU	P-U-11	1-1/2	3	JIC-86614269	32.31
LOADER LIFT	447173A1		JAF0350744- NA, JAF0371244- EU	P-U-10	40 mm	65 mm	JIC-86988486	31.01
	86614638		-JAF0371243 NA, - JAF0351854 EU	P-UB-11	1-1/2	2-1/2	JIC-86631598	32.48
STABILIZER Vertical	H514117			P-U-10	1	2	JIC-H52704	16.09
TILT	87438187			P-UB-11	1-3/8	2-3/4	JIC-86613643	47.48
	87438193			P-U-11	1-1/2	3	JIC-86614269	32.31
<b>MODEL 95XT</b>								
BACKHOE BOOM	1346450C2	1pc		P-UB-10	1-1/2	3	JIC-1543256C1	39.76
BACKHOE BUCKET	1346397C2	1pc		P-UB-10	1-1/2	2-3/4	JIC-1346409C2	89.29
BACKHOE DIPPER	1346411C2	1pc		P-UB-10	1-1/2	3	JIC-1543256C1	39.76
BACKHOE SWING	H673149			P-OB-1	2-3/4		JIC-H53041	21.85
LOADER LIFT	139091A3	1pc		P-UB-10,12	1-3/4	2-1/2	JIC-198376A2	50.12
STABILIZER (Fold Down)	101643A1	1pc		P-U-10	1-3/8	3	JIC-700710260	77.16
STABILIZER (Vertical)	H514117	1pc		P-U-10	1	2	JIC-H52704	16.09
TRENCHER BOOM LIFT	221700A1	1pc		P-U-10	1-3/4	3-1/2	JIC-235933A1	31.13
<b>MODEL 1818</b>								
BUCKET TILT	D136128	1pc		P-U-10	1	2	JIC-N14638	33.95
LOADER BUCKET	104517A1	1pc		P-U-10	1	2	JIC-110510A1	61.12
LOADER LIFT	104516A1	1pc		P-U-10	1-3/8	2	JIC-110507A1	61.12
	D136838	1pc		P-U-10	1-1/4	2	JIC-N14639	41.64
<b>MODEL 1825</b>								
BUCKET TILT	D136128	1pc		P-U-10	1	2	JIC-N14638	33.95
LOADER BUCKET	104517A1	1pc		P-U-10	1	2	JIC-110510A1	61.12
LOADER LIFT	104516A1	1pc		P-U-10	1-3/8	2	JIC-110507A1	61.12
	D136838	1pc		P-U-10	1-1/4	2	JIC-N14639	41.64
<b>MODEL 1835</b>								
GRAPPLE	D61075	1pc		P-U-10	1	2	JIC-D61006	7.71
LOADER BUCKET		1pc		P-UB-10	1-1/4	2-1/2	JIC-G109476	31.93
	G103407	1pc		P-U-10	1-1/4	2-1/2	JIC-G105507	26.36
LOADER LIFT		1pc		P-UB-10	1-1/2	2-1/2	JIC-G109458	23.43
	G34864	1pc		P-U-10	1-1/4	2-1/8	JIC-G34819	23.65
<b>MODEL 1835B</b>								
GRAPPLE	D61075	1pc		P-U-10	1	2	JIC-D61006	7.71
LOADER BUCKET	G103407	1pc		P-UB-10	1-1/4	2-1/2	JIC-G109476	31.93
LOADER LIFT		1pc		P-UB-10	1-1/2	2-1/2	JIC-G109458	23.43
	G106818	1pc		P-UB-10	1-1/2	2-1/2	JIC-128725A1	28.45
<b>MODEL 1835C</b>								
BUCKET TILT	118110A1	1pc	JAF0130838-	P-U-10	1-1/4	2-1/2	JIC-128728A1	24.08
	G103407	1pc	-JAF0130838	P-U-10	1-1/4	2-1/2	JIC-128728A1	24.08
GRAPPLE	D61075	1pc		P-U-10	1	2	JIC-D61006	7.71
LIFT		1pc		P-U-10	1-1/4	2-1/8	JIC-G34819	23.65
	117824A1	1pc	JAF0130838-	P-UB-10	1-1/2	2-1/2	JIC-128725A1	28.45
	G110666	1pc	-JAF0130838	P-UB-10	1-1/2	2-1/2	JIC-128725A1	28.45
<b>MODEL 1838</b>								
BACKHOE BOOM, DIPPER, & BUCKET	G100936	1pc		P-UB-10	1-1/2	3	JIC-1543252C1	42.22
BACKHOE DIPPER	G109376	1pc		P-UB-10	1-1/2	3	JIC-1543313C1	50.12
BACKHOE SWING	H514125			P-OB-1	2-3/4		JIC-H53041	21.85
GRAPPLE	D61010	1pc		P-U-10	1	2	JIC-D61006	7.71
LOADER BUCKET TILT	118110A1	1pc		P-U-10	1-1/4	2-1/2	JIC-128728A1	24.08
LOADER LIFT	117824A1	1pc		P-UB-10	1-1/2	2-1/2	JIC-128725A1	28.45





# CASE

Replacement Kits For

Loaders - Skid Steer								
APPLICATION	CYL #	Piston	SERIAL #	CODE	ROD	BORE	KIT #	List \$
<b>MODEL 1838</b>								
STABILIZER (Fold Down)	101643A1	1pc		P-U-10	1-3/8	3	JIC-700710260	77.16
STABILIZER (Vertical)	H514117	1pc		P-U-10	1	2	JIC-H52704	16.09
<b>MODEL 1840</b>								
BACKHOE BOOM	1346450C2	1pc		P-UB-10	1-1/2	3	JIC-1543256C1	39.76
BACKHOE BUCKET	1346397C2	1pc		P-UB-10	1-1/2	2-3/4	JIC-1346409C2	89.29
BACKHOE DIPPER	1346411C1	1pc		P-UB-10	1-1/2	3	JIC-1543256C1	39.76
BACKHOE SWING	H673149			P-OB-1	2-3/4		JIC-H53041	21.85
GRAPPLE	D61075	1pc		P-U-10	1	2	JIC-D61006	7.71
LOADER BUCKET TILT	118110A1	1pc		P-U-10	1-1/4	2-1/2	JIC-128728A1	24.08
	G103407	1pc		P-U-10	1-1/4	2-1/2	JIC-128728A1	24.08
LOADER LIFT	117824A1	1pc		P-UB-10	1-1/2	2-1/2	JIC-128725A1	28.45
	G110666	1pc		P-UB-10	1-1/2	2-1/2	JIC-128725A1	28.45
STABILIZER (Vertical)	H514117	1pc		P-U-10	1	2	JIC-H52704	16.09
<b>MODEL 1845, 1845S</b>								
4-IN-1 BUCKET	G33748	1pc		P-UB-10	1-1/2	3	JIC-1543313C1	50.12
BUCKET DUMP	G34926	1pc		P-U-10	1-1/4	2-1/2	JIC-G105507	26.36
LOADER LIFT - 1845	G37917	1pc		P-UB-10	1-1/2	2-1/2	JIC-128725A1	28.45
LOADER LIFT - 1845S	G100295	1pc		P-UB-10	1-1/2	2-1/2	JIC-128725A1	28.45
SCARIFIER	G33744	1pc		P-UB-10	1-1/2	3	JIC-1543313C1	50.12
<b>MODEL 1845B</b>								
LOADER BUCKET	G34926	1pc		P-UB-10	1-1/4	2-1/2	JIC-G109476	31.93
LOADER CLAM	G33748	1pc		P-UB-10	1-1/2	3	JIC-1543313C1	50.12
LOADER LIFT	G100295	1pc		P-UB-10	1-1/2	2-1/2	JIC-128725A1	28.45
SCARIFIER	G33744	1pc		P-UB-10	1-1/2	3	JIC-1543313C1	50.12
<b>MODEL 1845C</b>								
BACKHOE BOOM	1346450C2	1pc		P-UB-10	1-1/2	3	JIC-1543256C1	39.76
BACKHOE BUCKET	1346397C2	1pc		P-UB-10	1-1/2	2-3/4	JIC-1346409C2	89.29
BACKHOE DIPPER	1346411C1	1pc		P-UB-10	1-1/2	3	JIC-1543256C1	39.76
	G109376	1pc		P-UB-10	1-1/2	3	JIC-1543313C1	50.12
BACKHOE SWING	H673149			P-OB-1	2-3/4		JIC-H53041	21.85
BOOM, DIPPER, & BUCKET	G100936	1pc		P-UB-10	1-1/2	3	JIC-1543252C1	42.22
LOADER BUCKET	G34926	1pc		P-U-10	1-1/4	2-1/2	JIC-128728A1	24.08
LOADER LIFT	117903A1	1pc		P-UB-10	1-1/2	2-1/2	JIC-128725A1	28.45
	129011A1	1pc		P-UB-10	1-1/2	2-1/2	JIC-128725A1	28.45
	G109773	1pc		P-UB-10	1-1/2	2-1/2	JIC-128725A1	28.45
	G109777	1pc		P-UB-10	1-1/2	2-1/2	JIC-128725A1	28.45
STABILIZER	101643A1	1pc		P-U-10	1-3/8	3	JIC-700710260	77.16
	H514117	1pc		P-U-10	1	2	JIC-H52704	16.09
	H672226	1pc		P-U-10	1-3/8	3	JIC-700710260	77.16
SWING	H514125			P-OB-1	2-3/4		JIC-H53041	21.85
<b>Loaders - Wheel</b>								
APPLICATION	CYL #	Piston	SERIAL #	CODE	ROD	BORE	KIT #	List \$
<b>MODEL 521D</b>								
LOADER BUCKET	336396A2		-JEE0135500	P-UB-10	2-1/2	4-1/2	JIC-360982A1	66.42
	368885A1		-JEE0135500	P-UB-10	2-1/4	3-3/4	JIC-358013A1	52.18
LOADER BUCKET (XT)	87405381		JEE0135501-	P-UB-10	2-1/4	4-1/8	JIC-381101A1	91.27
	87446958		JEE0135501-	P-UB-10	2-1/4	4	JIC-360979A1	52.82
LOADER BUCKET (Z-BAR)	87366674		JEE0135501-	P-UB-3	2-1/2	4-1/2	JIC-87434291	66.42
	87405363		JEE0135501-	P-UB-10	2-1/2	4-1/2	JIC-360982A1	66.42
LOADER LIFT	337568A1		-JEE0135500	P-UB-10	2-1/4	4	JIC-360979A1	52.82
LOADER LIFT (XR)	87405374		JEE0135501-	P-UB-10	2-1/2	4-1/2	JIC-360982A1	66.42
LOADER LIFT (XT)	87366683		JEE0135501-	P-UB-10	2-1/4	4	JIC-360979A1	52.82
	87405367		JEE0135501-	P-UB-10	2-1/4	4	JIC-360979A1	52.82
LOADER LIFT (Z-BAR)	87405374		JEE0135501-	P-UB-10	2-1/2	4-1/2	JIC-360982A1	66.42
LOADER LIFT (Z-BAR/XT)	87317750		JEE0135501-	P-UB-10	2-1/4	4	JIC-360979A1	52.82

CASE



# CASE

Replacement Kits For

Loaders - Wheel								
APPLICATION	CYL #	Piston	SERIAL #	CODE	ROD	BORE	KIT #	List \$
<b>MODEL 521D</b>								
LOADER LIFT (Z-BAR/XT)	87366683		JEE0135501-	P-UB-10	2-1/4	4	JIC-360979A1	52.82
<b>MODEL 621</b>								
LOADER CLAM	S300146	1pc	-JAK0021701	I-U-10	2	4	JIC-S300163	23.18
	S301479	1pc	JAK0021701-	I-U-10	2	4	JIC-S301442	35.16
LOADER LIFT	134596C1		JAK0021701-	P-UB-10	3	5	JIC-1543305C1	88.92
	G110354	1pc	JAK0021700-	P-UB-10	3	5	JIC-1543305C1	88.92
	G110355	1pc	-JAK0021700	P-UB-10	3	5	JIC-1543305C1	88.92
LOADER TILT	1343552C2	1pc	JAK0020901-	P-UB-10	3	6	JIC-G110526	90.32
	1980354C1		JAK0020286- JAK0020900	P-UB-10	3	6	JIC-G110526	90.32
	G110312	1pc	-JAK0020286	P-UB-10	3	6	JIC-G110526	90.32
STEERING	1976862C1	1pc	ALL	P-UB-10	1-3/4	3	JIC-G110049	38.47
<b>MODEL 621B</b>								
LOADER CLAM	S301431	1pc		I-U-10	2	4	JIC-S301442	35.16
LOADER LIFT	1343595C1			P-UB-10	3	5	JIC-1543305C1	88.92
	1343596C1	1pc		P-UB-10	3	5	JIC-1543305C1	88.92
LOADER TILT, XT LOADER	112551A1	1pc		P-UB-10	2-1/4	4-1/2	JIC-1543279C1	56.53
LOADER TILT, Z-BAR	1343552C2	1pc		P-UB-10	3	6	JIC-G110526	90.32
STEERING	1976862C1	1pc		P-UB-10	1-3/4	3	JIC-1543267C1	49.14
<b>MODEL 621C</b>								
LOADER LIFT	280706A1		ALL	P-UB-10	3	5	JIC-1543305C1	88.92
LOADER TILT	112551A1		ALL	P-UB-10	2-1/4	4-1/2	JIC-1543279C1	56.53
	125872A1		ALL	P-UB-10	3	6	JIC-1543306C1	107.23
	1343552C2		ALL	P-UB-10	3	6	JIC-1543306C1	107.23
STEERING	1976862C1		ALL	P-UB-10	1-3/4	3	JIC-1543267C1	49.14
<b>MODEL 621D</b>								
LOADER BUCKET (XR)	87366695		JEE0135501-	P-UB-3	3	5	JIC-87434293	79.41
	87405382		JEE0135501-	P-UB-10	3	5	JIC-360984A1	79.41
LOADER BUCKET (XT)	87405381		JEE0135501-	P-UB-10	2-1/4	4-1/8	JIC-381101A1	91.27
	87442555		JEE0135501-	P-UB-10	2-1/2	4-1/2	JIC-360982A1	66.42
LOADER BUCKET (Z-BAR)	87366688		JEE0135501-	P-UB-3	3	5	JIC-87434293	79.41
	87405371		JEE0135501-	P-UB-10	3	5	JIC-360984A1	79.41
LOADER LIFT	87318060		JEE0135501-	P-UB-10	2-1/2	4-1/2	JIC-360982A1	66.42
	87366691		JEE0135501-	P-UB-10	2-1/2	4-1/2	JIC-360982A1	66.42
	87405374		JEE0135501-	P-UB-10	2-1/2	4-1/2	JIC-360982A1	66.42
<b>MODEL 721</b>								
LOADER CLAM	S300146	1pc		I-U-10	2	4	JIC-S300163	23.18
	S301431			I-U-10	2	4	JIC-S301442	35.16
	S301479	1pc		I-U-10	2	4	JIC-S301442	35.16
LOADER LIFT	1343595C1			P-UB-10	3	5	JIC-1543305C1	88.92
	1343596C1			P-UB-10	3	5	JIC-1543305C1	88.92
	G110354	1pc		P-UB-10	3	5	JIC-1543305C1	88.92
	G110355			P-UB-10	3	5	JIC-1543305C1	88.92
LOADER TILT	1345991C1	1pc	JAK0022102- JAK0022217	P-UB-10	3	6-1/2	JIC-1543303C1	149.02
	1980347C4	1pc	JAK002218-	P-UB-10	3	6-1/2	JIC-1543303C1	149.02
STEERING	1976862C1	1pc		P-UB-10	1-3/4	3	JIC-G110049	38.47
<b>MODEL 721B</b>								
LOADER CLAM	S301431	1pc		I-U-10	2	4	JIC-S301442	35.16
LOADER LIFT	1343595C1	1pc		P-UB-10	3	5	JIC-1543305C1	88.92
	1343596C1	1pc		P-UB-10	3	5	JIC-1543305C1	88.92
LOADER TILT, XT LOADER	112551A1	1pc		P-UB-10	2-1/4	4-1/2	JIC-1543279C1	56.53
LOADER TILT, Z-BAR	1980347C4	1pc		P-UB-10	3	6-1/2	JIC-1543303C1	149.02
STEERING	1976862C1	1pc		P-UB-10	1-3/4	3	JIC-1543267C1	49.14
<b>MODEL 721C</b>								
LOADER LIFT	280706A1		ALL	P-UB-10	3	5	JIC-1543305C1	88.92



# CASE

Replacement Kits For

Loaders - Wheel								
APPLICATION	CYL #	Piston	SERIAL #	CODE	ROD	BORE	KIT #	List \$
<b>MODEL 721C</b>								
LOADER TILT	112551A1		ALL	P-UB-10	2-1/4	4-1/2	JIC-1543279C1	56.53
	125873A1		ALL	P-UB-10	3	6-1/2	JIC-1543303C1	149.02
	308986A1		ALL	P-UB-10	3	6-1/2	JIC-1543303C1	149.02
STEERING	1976862C1		ALL	P-UB-10	1-3/4	3	JIC-1543267C1	49.14
<b>MODEL 721D</b>								
LOADER BUCKET (XT)	87324809		01/03-	I-UB-10	2-1/4	4-1/2	JIC-87440117	45.85
	87440056		01/03-	I-UB-10	2-1/4	4-1/2	JIC-87440117	45.85
LOADER BUCKET (Z-BAR)	8605291		01/03-	P-UB-10	3	5-3/4	JIC-8605263	84.39
	87441197		01/03-	P-UB-10	3	5-3/4	JIC-87442965	84.39
LOADER LIFT (Z-BAR/XT)	8605290		01/03-	P-UB-10	3	4-3/4	JIC-8605262	96.93
	87318066		01/03-	P-UB-10	3	4-3/4	JIC-8605262	96.93
<b>MODEL 821</b>								
LOADER CLAM	S301000	1pc		I-U-10	2-1/2	5	JIC-S301013	58.93
LOADER LIFT	1340743C3	1pc		P-UB-10	3	6	JIC-G110526	90.32
	1986601C1	1pc		P-UB-10	3-1/2	6	JIC-1986823C2	148.71
LOADER TILT	1980385C3	1pc		P-UB-10	3-1/2	7	JIC-1543309C1	155.67
STEERING	1986978C1		JAK0024132-	P-UB-10	1-3/4	3-1/2	JIC-G110621	40.07
	1994558C1	1pc	JAK0024132	P-UB-10	1-3/4	3-1/2	JIC-G110621	40.07
<b>MODEL 821B</b>								
LOADER CLAM	S301000	1pc		I-U-10	2-1/2	5	JIC-S301013	58.93
LOADER LIFT	1986601C1	1pc		P-UB-10	3-1/2	6	JIC-1986823C2	148.71
LOADER TILT	1980386C3	1pc		P-UB-10	3-1/2	7	JIC-1543309C1	155.67
STEERING	1986978C1	1pc		P-UB-10	1-3/4	3-1/2	JIC-1543266C1	50.06
<b>MODEL 821C</b>								
LOADER LIFT	1986601C1		ALL	P-UB-10	3-1/2	6	JIC-1986823C2	148.71
LOADER TILT	190385C3		ALL	P-UB-10	3-1/2	7	JIC-1543309C1	155.67
STEERING	229402A1		ALL	P-UB-10	1-3/4	3-1/2	JIC-1543266C1	50.06
<b>MODEL 821E</b>								
LOADER BUCKET (XR)	87696084		8/06-	P-UB-10	3-1/2	6-1/2	JIC-87529743	171.32
LOADER BUCKET (Z-BAR)	87337179		8/06-	P-UB-10	3-1/2	6-1/2	JIC-87529743	171.32
LOADER LIFT	87337177		8/06-	P-UB-10	3	5-1/4	JIC-87530718	105.29
STEERING	87307850		8/06-	P-UB-10	1-3/4	3-1/4	JIC-87363451	117.22
<b>MODEL 921</b>								
LOADER LIFT	1986603C1	1pc		P-UB-10	4	7	JIC-1986920C2	171.34
LOADER TILT	1346171C3	1pc		P-UB-10	4	8	JIC-1346357C2	223.49
STEERING	1346169C2	1pc	1346267C1 & 1346268C1	P-UB-10	2	4	JIC-1543269C1	61.25
	1346169C2	1pc	1346269C1 Gland	P-UB-10	2	4	JIC-1543269C1	61.25
<b>MODEL 921C</b>								
LOADER LIFT	1986603C1		ALL	P-UB-10	4	7	JIC-1986920C2	171.34
LOADER TILT	1346171C3		ALL	P-UB-10	4	8	JIC-1346357C2	223.49
STEERING	1346169C4		ALL	P-UB-10	2	4	JIC-1543269C1	61.25
<b>MODEL W3</b>								
BACKHOE BOOM				I-U-1	2		JIC-D42876	19.32
		2pc		N-N-9		4	JIC-G33239	25.19
BACKHOE BUCKET				P-U-1	1-3/4		JIC-D42873	21.01
		2pc		N-N-9		3-1/2	JIC-G33237	23.09
BACKHOE DIPPER				I-U-1	2		JIC-D42876	19.32
		2pc		N-N-9		4	JIC-G33239	25.19
BACKHOE STABILIZER				P-U-1	1-3/4		JIC-D42873	21.01
		2pc		N-N-9		3-1/2	JIC-G33237	23.09
LOADER LIFT				P-U-1	1-1/2		JIC-D42870	20.47
		2pc		N-N-9		3	JIC-G33151	20.85
LOADER TILT				P-U-1	1-1/2		JIC-D42869	20.62
		2pc		N-N-9		2-1/2	JIC-G33193	20.35

CASE



# CASE

Replacement Kits For

Loaders - Wheel								
APPLICATION	CYL #	Piston	SERIAL #	CODE	ROD	BORE	KIT #	List \$
<b>MODEL W7, W7C, W7E</b>								
BACKHOE BOOM		2pc		P-U-9	2	4	JIC-G32299	51.90
		2pc		P-UB-9	2-1/4	4-1/2	JIC-G105520	88.28
				P-U-1	2-1/4		JIC-D42878	18.66
				I-U-1	2		JIC-D42876	19.32
		2pc		N-N-9		4-1/2	JIC-DTVS4.5P	51.78
		2pc		N-N-9		3	JIC-G33151	20.85
BACKHOE BUCKET		2pc		P-UB-9	2-1/4	4	JIC-G34636	59.90
		2pc		P-U-9	2	3-1/2	JIC-G32293	40.26
				I-U-1	2-1/4		JIC-D42877	15.20
				I-U-1	2		JIC-D42874	16.35
				P-U-1	1-3/4		JIC-D42873	21.01
		2pc		N-N-9		4	JIC-G33239	25.19
		2pc		N-N-9		3-1/2	JIC-G33237	23.09
		2pc		P-UB-9	2-1/4	4-1/2	JIC-G105520	88.28
BACKHOE DIPPER		2pc		P-U-9	2	4	JIC-G32299	51.90
				I-U-1	2		JIC-D42876	19.32
				P-U-1	2-1/4		JIC-D42878	18.66
		2pc		N-N-9		4-1/2	JIC-DTVS4.5P	51.78
		2pc		N-N-9		4	JIC-G33239	25.19
		2pc		N-N-9		3-1/2	JIC-G33237	23.09
BACKHOE STABILIZER		2pc		P-U-9	2	4	JIC-G32299	51.90
		2pc		P-U-9	1-3/4	3-1/2	JIC-G105518	44.55
		2pc		P-UB-9	1-3/4	3-1/2	JIC-G105529	41.78
				I-U-1	2		JIC-D42876	19.32
				P-U-1	1-3/4		JIC-D42873	21.01
		2pc		N-N-9		4	JIC-G33239	25.19
		2pc		N-N-9		3-1/2	JIC-G33237	23.09
		2pc		P-UB-9	1-3/4	4	JIC-G105519	49.76
BACKHOE SWING				P-U-1	1-3/4		JIC-D42875	16.26
		2pc		N-N-9		4	JIC-G33239	25.19
		2pc		P-U-9	2	4	JIC-G32299	51.90
LOADER LIFT				I-U-1	2		JIC-D42876	19.32
		2pc		N-N-9		4	JIC-G33239	25.19
		2pc		P-UB-9	1-1/2	3	JIC-G105512	52.15
<b>MODEL W8E</b>								
LOADER LIFT		2pc		P-U-9	2-1/2	5	JIC-G32184	68.86
LOADER TILT		2pc		P-U-9	1-3/4	3-1/2	JIC-G32228	39.76
<b>MODEL W9, W9A, W9B, W9C, W9E, W10, W10B, W10C, W10E</b>								
BACKHOE BOOM		2pc		P-U-9	2	4	JIC-G32299	51.90
		2pc		P-UB-9	2-1/4	4-1/2	JIC-G105520	88.28
				I-U-1	2		JIC-D42876	19.32
				P-U-1	2-1/4		JIC-D42878	18.66
		2pc		N-N-9		4-1/2	JIC-DTVS4.5P	51.78
		2pc		N-N-9		4	JIC-G33239	25.19
BACKHOE BUCKET		2pc		P-U-9	2	3-1/2	JIC-G32293	40.26
		2pc		P-UB-9	2-1/4	4	JIC-G34636	59.90
				P-U-1	1-3/4		JIC-D42873	21.01
				I-U-1	2		JIC-D42874	16.35
				I-U-1	2-1/4		JIC-D42877	15.20
		2pc		N-N-9		3-1/2	JIC-G33237	23.09
		2pc		N-N-9		4	JIC-G33239	25.19
		2pc		P-UB-9	2-1/4	4-1/2	JIC-G105520	88.28
BACKHOE DIPPER		2pc		P-U-9	2	4	JIC-G32299	51.90
				P-U-1	2-1/4		JIC-D42878	18.66
				I-U-1	2		JIC-D42876	19.32
		2pc		N-N-9		4	JIC-G33239	25.19
		2pc		N-N-9		4-1/2	JIC-DTVS4.5P	51.78



# CASE

Replacement Kits For

Loaders - Wheel								
APPLICATION	CYL #	Piston	SERIAL #	CODE	ROD	BORE	KIT #	List \$
<b>MODEL W9, W9A, W9B, W9C, W9E, W10, W10B, W10C, W10E</b>								
BACKHOE STABILIZER		2pc		P-UB-9	1-3/4	3-1/2	JIC-G105529	41.78
		2pc		P-U-9	1-3/4	3-1/2	JIC-G105518	44.55
		2pc		P-U-9	2	4	JIC-G32299	51.90
				P-U-1	1-3/4		JIC-D42873	21.01
				I-U-1	2		JIC-D42876	19.32
		2pc		N-N-9		4	JIC-G33239	25.19
		2pc		N-N-9		3-1/2	JIC-G33237	23.09
BACKHOE SWING		2pc		P-UB-9	1-3/4	4	JIC-G105519	49.76
				P-U-1	1-3/4		JIC-D42875	16.26
		2pc		N-N-9		4	JIC-G33239	25.19
LOADER LIFT		2pc		P-U-9	2-1/2	5	JIC-G32184	68.86
LOADER TILT		2pc		P-U-9	1-3/4	3-1/2	JIC-G32228	39.76
<b>MODEL W11, W11B</b>								
LOADER CLAM		1pc		P-UB-10	1-3/4	3	JIC-1543262C1	40.59
LOADER LIFT		1pc		P-UB-10	2	3-1/2	JIC-G109453	43.95
LOADER TILT		1pc		P-UB-10	1-1/2	2-1/2	JIC-1543253C1	43.06
STEERING		1pc		P-UB-10	1-1/2	3	JIC-G109452	29.65
<b>MODEL W14, W14L, W14H</b>								
BACKHOE BOOM		1pc		P-UB-10	2-1/4	4	JIC-G109505	46.61
		1pc		P-UB-10	1-3/4	3-1/4	JIC-1543265C1	50.29
		2pc		P-UB-9	1-3/4	3-1/4	JIC-G105528	47.83
		2pc		P-UB-9	2-1/4	4	JIC-G34636	59.90
BACKHOE BUCKET		1pc		P-UB-10	2-1/2	3-1/2	JIC-G109504	43.39
		1pc		P-UB-10	2	3-1/2	JIC-G109453	43.95
		1pc		P-UB-10	2-1/2	4	JIC-G109424	51.32
		1pc		P-UB-10	1-3/4	3	JIC-1543262C1	40.59
		2pc		P-UB-9	2	3-1/2	JIC-G109454	34.85
		2pc		P-UB-10	1-1/2	3	JIC-G109452	29.65
		2pc		P-UB-9	1-3/4	3	JIC-G109462	36.31
		2pc		P-UB-9	2	4	JIC-G109421	45.05
BACKHOE DIPPER		2pc		P-UB-9	2	3-1/2	JIC-G109454	34.85
		2pc		P-UB-9	2	4	JIC-G109421	45.05
		1pc		P-UB-10	2	4	JIC-1543273C1	64.28
		1pc		P-UB-10	2	3-1/2	JIC-G109453	43.95
BACKHOE DIPPER EXT		2pc		P-UB-9	1-1/2	3	JIC-G105512	52.15
		1pc		P-UB-10	1-1/2	3	JIC-G109452	29.65
BACKHOE STABILIZER		1pc		P-UB-10	1-3/4	3-1/2	JIC-G109471	42.84
		2pc		P-UB-9	2	4	JIC-G109421	45.05
		2pc		P-UB-9	1-3/4	3-1/2	JIC-G109470	38.50
		1pc		P-UB-10	2	4	JIC-1543273C1	64.28
BACKHOE SWING		2pc		P-U-9	1-1/2	3-1/2	JIC-G34652	39.20
		1pc		P-UB-10	2	4	JIC-1543273C1	64.28
		2pc		P-UB-9	2	4	JIC-G109421	45.05
		1pc		P-UB-10	1-1/2	3-1/2	JIC-G109472	40.50
LOADER CLAM		1pc		P-UB-10	1-1/2	3	JIC-G109452	29.65
		2pc		P-UB-9	1-1/2	3	JIC-G105512	52.15
LOADER GRAPPLE		1pc		P-UB-10	1-1/2	3	JIC-G109418	29.45
LOADER LIFT		2pc		P-UB-9	2-1/4	4-1/2	JIC-G105520	88.28
LOADER TILT		2pc		P-UB-9	1-3/4	3	JIC-G109462	36.31
		1pc		P-UB-10	1-3/4	3	JIC-1543262C1	40.59
STEERING		1pc		P-UB-10	1-1/4	2-1/2	JIC-G109475	33.21
		2pc		P-U-9	1-1/4	2-1/2	JIC-G32295	45.16
<b>MODEL W14B</b>								
LOADER CLAM		1pc		P-UB-10	1-1/2	3	JIC-G109452	29.65
LOADER GRAPPLE		1pc		P-UB-10	1-1/2	3	JIC-G109418	29.45
LOADER LIFT		2pc		P-UB-9	2-1/4	4-1/2	JIC-G105520	88.28

CASE



# CASE

Replacement Kits For

Loaders - Wheel								
APPLICATION	CYL #	Piston	SERIAL #	CODE	ROD	BORE	KIT #	List \$
<b>MODEL W14B</b>								
LOADER TILT		1pc		P-UB-10	2	3-1/2	JIC-G109453	43.95
STEERING		1pc		P-UB-10	1-1/4	2-1/2	JIC-G109475	33.21
<b>MODEL W18, W20, W20B</b>								
LOADER CLAM		1pc		P-UB-10	2	4	JIC-1543273C1	64.28
		2pc		P-U-9	2	4	JIC-G32299	51.90
LOADER LIFT		2pc	-9115602	P-U-9	3	5	JIC-G32668	76.65
		2pc	9115603-9123139	P-U-9	3	5	JIC-G109502	87.46
		2pc	9123140-	P-UB-9	2-1/2	5	JIC-G105515	77.48
LOADER TILT		2pc		P-UB-9	2	4	JIC-G109421	45.05
		1pc		P-UB-10	2	4	JIC-1543273C1	64.28
STEERING		1pc		P-UB-10	1-1/2	3	JIC-G109452	29.65
		2pc		P-UB-9	1-1/2	3	JIC-G105512	52.15
<b>MODEL W18B, W20C</b>								
LOADER LIFT		2pc	ALL	P-UB-9	2-1/2	5	JIC-G105515	77.48
LOADER TILT		1pc		P-UB-10	2	4	JIC-1543273C1	64.28
STEERING		1pc		P-UB-10	1-1/2	3	JIC-G109452	29.65
<b>MODEL W24</b>								
LOADER CLAM		2pc		P-U-9	2	4	JIC-G32299	51.90
				I-U-1	2		JIC-D42876	19.32
		2pc		N-N-9		4	JIC-G33239	25.19
LOADER LIFT		2pc		P-U-9	3	5	JIC-G32668	76.65
LOADER TILT		2pc		P-UB-9	2-1/2	4-1/2	JIC-G105513	91.03
STEERING		2pc		N-N-9		3	JIC-G33151	20.85
			-9105108	P-U-1	1-1/2		JIC-D42870	20.47
		2pc	9105109-	P-UB-9	1-1/2	3	JIC-G105512	52.15
<b>MODEL W24B</b>								
LOADER CLAM		2pc		P-U-9	2	4	JIC-G34335	52.99
		2pc		P-U-9	2	4	JIC-G32299	51.90
		1pc		P-UB-10	2	4	JIC-1543273C1	64.28
LOADER LIFT		2pc		P-U-9	3	5	JIC-G32668	76.65
		2pc		P-UB-9	3	5	JIC-G105531	88.67
		2pc		P-U-9	3	5	JIC-G34334	94.50
LOADER TILT		2pc		P-UB-9	2-1/2	4-1/2	JIC-G105513	91.03
STEERING		1pc		P-UB-10	1-1/2	3	JIC-G105548	39.05
		2pc		P-UB-9	1-1/2	3	JIC-G105512	52.15
<b>MODEL W24C</b>								
LOADER CLAM		1pc		P-UB-10	2	4	JIC-1543273C1	64.28
LOADER LIFT		2pc		P-UB-9	3	5	JIC-G105531	88.67
LOADER TILT		2pc		P-UB-9	2-1/2	4-1/2	JIC-G105513	91.03
STEERING		1pc		P-UB-10	1-1/2	3	JIC-G105548	39.05
<b>MODEL W26B, W26FL</b>								
LOADER LIFT		2pc	9107499-	P-UB-9	3	6	JIC-G105516	95.29
LOADER TILT		2pc		P-U-9	2-1/2	5	JIC-G32184	68.86
		2pc		P-UB-9	2-1/2	5	JIC-G105515	77.48
STEERING		2pc		P-U-9	2	3-1/2	JIC-G32293	40.26
		2pc		P-UB-9	2	3-1/2	JIC-G105527	52.45
				I-U-1	2		JIC-D42874	16.35
		2pc		N-N-9		3-1/2	JIC-G33237	23.09
<b>MODEL W30</b>								
LOADER CLAM		1pc		P-UB-10	2	4	JIC-1543273C1	64.28
LOADER TILT		2pc		P-UB-9	2-1/4	4-1/2	JIC-G105520	88.28
STEERING		1pc		P-UB-10	1-3/4	3-1/4	JIC-G105547	44.90
<b>MODEL W36</b>								
LOADER LIFT		2pc		P-UB-9	3	6	JIC-G105516	95.29
LOADER TILT		2pc		P-UB-9	2-1/4	4-1/2	JIC-G105520	88.28
STEERING		2pc		P-UB-9	2	4	JIC-G105517	54.98





# CASE

Replacement Kits For

Loaders - Wheel								
APPLICATION	CYL #	Piston	SERIAL #	CODE	ROD	BORE	KIT #	List \$
MODEL W36								
STEERING		1pc		P-UB-10	2	4	JIC-1543273C1	64.28
Uni-Loaders								
APPLICATION	CYL #	Piston	SERIAL #	CODE	ROD	BORE	KIT #	List \$
MODEL 1530B								
BUCKET		1pc		P-UB-10	1-1/2	3	JIC-G105502	37.90
BUCKET CLAM		1pc		P-UB-10	1-1/2	3	JIC-G105502	37.90
GRAPPLE		1pc		P-U-10	1	2	JIC-D61006	7.71
LIFT		1pc	-9818250	P-UB-10	1-1/2	3	JIC-G105502	37.90
		1pc	9818251-	P-UB-10	1-1/2	2-1/2	JIC-G109458	23.43
SCARIFIER		1pc		P-UB-10	1-1/2	3	JIC-G105502	37.90
WOOD TICK		1pc		P-UB-10	1-1/2	3	JIC-G105502	37.90
MODEL 1700								
BUCKET		1pc		P-UB-10	1-1/2	3	JIC-G105502	37.90
BUCKET CLAM		1pc		P-UB-10	1-1/2	3	JIC-G105502	37.90
GRAPPLE		1pc		P-U-10	1	2	JIC-D61006	7.71
LIFT		1pc		P-UB-10	1-1/2	3	JIC-G105502	37.90
SCARIFIER		1pc		P-UB-10	1-1/2	3	JIC-G105502	37.90
WOOD TICK		1pc		P-UB-10	1-1/2	3	JIC-G105502	37.90
MODEL 1816B, 1816C								
BUCKET		1pc		P-U-10	1	2	JIC-D61006	7.71
GRAPPLE		1pc		P-U-10	1	2	JIC-D61006	7.71
LIFT		1pc		P-U-10	1	2	JIC-D61006	7.71
MODEL 1818								
BUCKET TILT	D136128			P-U-10	1	2	JIC-N14638	33.95
LOADER LIFT	D136838			P-U-10	1-1/4	2	JIC-N14639	41.64
MODEL 1825								
BUCKET 4-IN-1	E99740			P-U-10	1	2	JIC-N14638	33.95
BUCKET TILT	D136128			P-U-10	1	2	JIC-N14638	33.95
LOADER LIFT	D136838			P-U-10	1-1/4	2	JIC-N14639	41.64
MODEL 1830								
BUCKET		1pc		P-U-10	1	2-1/2	JIC-G34807	16.48
		1pc		P-U-10	1	2-1/2	JIC-G35378	15.90
		1pc		P-U-10	1-1/4	2-1/2	JIC-G105507	26.36
GRAPPLE		1pc		P-U-10	1	2	JIC-D61006	7.71
LIFT		1pc		P-U-10	1-1/4	2-1/8	JIC-G34819	23.65
SCARIFIER		1pc		P-UB-10	1-1/2	3	JIC-G105502	37.90
MODEL 1835, 1835B								
BUCKET		1pc		P-UB-10	1-1/4	2-1/2	JIC-G109476	31.93
GRAPPLE		1pc		P-U-10	1	2	JIC-D61006	7.71
LIFT		1pc		P-UB-10	1-1/2	2-1/2	JIC-G109458	23.43
		1pc		P-U-10	1-1/4	2-1/8	JIC-G34819	23.65
MODEL 1840								
BUCKET TILT	118110A1			P-U-10	1-1/4	2-1/2	JIC-128728A1	24.08
	G103407			P-U-10	1-1/4	2-1/2	JIC-128728A1	24.08
GRAPPLE	D61075			P-U-10	1	2	JIC-D61006	7.71
LOADER LIFT	117824A1			P-UB-10	1-1/2	2-1/2	JIC-128725A1	28.45
	G110666	1pc		P-UB-10	1-1/2	2-1/2	JIC-G109458	23.43
MODEL 1845, 1845B, 1845C, 1845S								
BUCKET		1pc		P-UB-10	1-1/4	2-1/2	JIC-G109476	31.93
CLAM		1pc		P-UB-10	1-1/2	3	JIC-G109418	29.45
LIFT		1pc		P-UB-10	1-1/2	2-1/2	JIC-G109458	23.43
SCARIFIER		1pc		P-UB-10	1-1/2	3	JIC-G109418	29.45
Unimogs								
APPLICATION	CYL #	Piston	SERIAL #	CODE	ROD	BORE	KIT #	List \$
MODEL MB4/94 with Model 26C Backhoe, P80 Cable Plow, T70								
3-PT HITCH LIFT		2pc		P-UB-9	1-1/2	3	JIC-G105512	52.15

CASE



# CASE

Replacement Kits For

Unimogs								
APPLICATION	CYL #	Piston	SERIAL #	CODE	ROD	BORE	KIT #	List \$
MODEL MB4/94 with Model 26C Backhoe, P80 Cable Plow, T70								
3-PT HITCH LIFT		1pc		P-UB-10	1-1/2	3	JIC-G105548	39.05
3-PT HITCH PITCH		1pc		P-U-10	1-1/4	2-1/2	JIC-G105507	26.36
BACKHOE BOOM		2pc		P-UB-9	2-1/4	4	JIC-G34636	59.90
		1pc		P-UB-10	2-1/4	4	JIC-G105556	50.75
BACKHOE BUCKET		2pc		P-UB-9	1-3/4	3	JIC-G105524	57.47
		1pc		P-UB-10	1-3/4	3	JIC-G105549	49.69
BACKHOE DIPPER		2pc		P-UB-9	2	3-1/2	JIC-G105527	52.45
		1pc		P-UB-10	2	3-1/2	JIC-G105546	46.94
BACKHOE DIPPER EXT		1pc		P-UB-10	1-1/2	3	JIC-G105548	39.05
		2pc		P-UB-9	1-1/2	3	JIC-G105512	52.15
BACKHOE STABILIZER		1pc		P-UB-10	1-3/4	3	JIC-G105549	49.69
		2pc		P-UB-9	1-3/4	3	JIC-G105524	57.47
		2pc		P-U-9	1-3/4	3-1/2	JIC-G105518	44.55
BACKHOE SWING		2pc		P-U-9	1-1/2	3-1/2	JIC-G34652	39.20
		1pc		P-UB-10	1-1/2	3-1/2	JIC-G105555	36.74
CABLE PLOW SHIFT		1pc		P-UB-10	1-1/2	2-1/2	JIC-G105550	29.30
FORKLIFT MAST TILT		1pc		P-UB-10	1-1/4	3	JIC-G105510	26.93
LIFT		2pc		P-UB-9	1-3/4	3	JIC-G105524	57.47
TILT		2pc		P-U-9	1-1/2	3-1/2	JIC-G34646	38.55
		1pc		P-UB-10	1-1/2	3	JIC-G105502	37.90

CASE



# REPLACEMENT KITS FOR CASE EQUIPMENT

## IMPORTANT - PLEASE READ

If a kit part number is unknown, the machine model number, serial number, and cylinder application will help identify the repair kit you need.

Example: Model Number **580C**  
 Serial Number **5411021**  
 Cylinder Application **Backhoe Swing**

If none of the above information is known, size and description of the parts needed will almost always be sufficient.

Kit Number	Code (Pg. xviii)	Rod X Bore Size	List Price
JIC-110507A1	P-U-10	1-3/8 X 2	\$ 61.12
JIC-110510A1	P-U-10	1 X 2	61.12
JIC-122535A1	P-UB-10	2 X 4	99.07
JIC-128725A1	P-UB-10	1-1/2 X 2-1/2	28.45
JIC-128728A1	P-U-10	1-1/4 X 2-1/2	24.08
JIC-131750A2	P-UB-10	2-1/4 X 3-1/4	62.16
JIC-131790A1	P-UB-10	2-1/4 X 4-1/4	42.19
JIC-1343707C2	P-UB-10	2-1/2 X 4-1/2	67.20
JIC-1346357C2	P-UB-10	4 X 8	223.49
JIC-1346409C2	P-UB-10	1-1/2 X 2-3/4	89.29
JIC-1346478C2	P-UB-10	2-1/4 X 4	84.36
JIC-135352A1	P-UB-10	2 X 3	41.17
JIC-1542764C2	I-UB-10	1-1/2 X 2-1/2	51.47
JIC-1542874C1	N-UB-1	1-1/2	12.79
JIC-1542875C1	N-UB-1	1-3/4	17.66
JIC-1542877C1	N-UB-1	2-1/4	16.27
JIC-1542879C1	P-UB-10	2-1/2 X 5	62.19
JIC-1542881C1	N-UB-1	3	31.98
JIC-1542882C1	N-UB-1	3-1/2	38.48
JIC-1542915C2	P-UB-10	2-1/2 X 5	59.99
JIC-1542919C2	P-UB-10	2-1/4 X 5	135.72
JIC-1542919C4	P-UB-10	2-1/4 X 5	148.11
JIC-1542923C2	P-UB-10	2-1/2 X 3-1/2	63.46
JIC-1542946C1	P-UB-10	1-1/4 X 2-3/4	61.39
JIC-1543249C1	P-UB-10	1-1/4 X 2-1/2	46.16
JIC-1543250C1	P-UB-10	1-1/4 X 2-1/2	36.71
JIC-1543252C1	P-UB-10	1-1/2 X 3	42.22
JIC-1543253C1	P-UB-10	1-1/2 X 2-1/2	43.06
JIC-1543254C1	P-UB-10	1-1/2 X 3-1/2	46.23
JIC-1543256C1	P-UB-10	1-1/2 X 3	39.76
JIC-1543260C1	P-UB-10	1-3/4 X 3-1/4	50.29
JIC-1543261C1	p-ub-10	1-3/4 x 3-1/2	46.24
JIC-1543262C1	P-UB-10	1-3/4 X 3	40.59
JIC-1543263C1	P-UB-9	1-3/4 X 3	59.40
JIC-1543264C1	P-UB-10	1-3/4 X 4	51.14
JIC-1543265C1	P-UB-10	1-3/4 X 3-1/4	50.29
JIC-1543266C1	P-UB-10	1-3/4 X 3-1/2	50.06
JIC-1543267C1	P-UB-10	1-3/4 X 3	49.14

Kit Number	Code (Pg. xviii)	Rod X Bore Size	List Price
JIC-1543268C1	P-UB-10	2 X 3-1/4	\$ 54.82
JIC-1543269C1	P-UB-10	2 X 4	61.25
JIC-1543270C1	P-UB-10	2 X 4-1/2	93.22
JIC-1543271C1	P-UB-9	2 X 4	53.83
JIC-1543273C1	P-UB-10	2 X 4	64.28
JIC-1543274C1	P-UB-10	2 X 3-1/2	65.64
JIC-1543275C1	P-UB-10	2 X 4-1/4	64.70
JIC-1543276C1	P-UB-9	2-1/4 X 4-1/2	96.38
JIC-1543277C1	P-UB-10	2-1/4 X 4	56.84
JIC-1543279C1	P-UB-10	2-1/4 X 4-1/2	56.53
JIC-1543289C2	P-UB-10	2-1/4 X 5	77.40
JIC-1543290C1	P-UB-10	2-1/2 X 4-1/2	46.70
JIC-1543291C1	P-UB-10	2-1/2 X 4-1/2	85.37
JIC-1543294C1	P-UB-10	2-1/2 X 3-1/2	46.24
JIC-1543295C1	P-UB-10	2-1/2 X 4	61.70
JIC-1543303C1	P-UB-10	3 X 6-1/2	149.02
JIC-1543305C1	P-UB-10	3 X 5	88.92
JIC-1543306C1	P-UB-10	3 X 6	107.23
JIC-1543309C1	P-UB-10	3-1/2 X 7	155.67
JIC-1543312C1	P-UB-9	2-1/2 X 5	97.24
JIC-1543313C1	P-UB-10	1-1/2 X 3	50.12
JIC-1543316C1	P-UB-10	1-1/4 X 3	47.30
JIC-1543360C1	P-UB-9	2-1/2 X 5	182.97
JIC-1543378C1	P-UB-9	1-1/2X3	75.77
JIC-1543383C1	P-UB-9	2 X 3-1/2	78.74
JIC-1543385C1	P-UB-10	2-1/4 X 4-1/2	55.51
JIC-156002A1	P-UB-10	110 X 160 mm	462.37
JIC-158846A1	P-UB-10	95 X 140 mm	360.38
JIC-160227A1	P-UB-10	105 X 150 mm	374.11
JIC-160229A1	P-UB-10	90 X 135 mm	273.04
JIC-160577A1	P-UB-10	85 X 125 mm	253.28
JIC-160579A1	P-UB-10	100 X 135 mm	359.26
JIC-160581A1	P-UB-10	80 X 120 mm	233.91
JIC-161912A1	P-UB-10	80 X 115 mm	265.30
JIC-161913A1	P-UB-10	90 X 125 mm	316.86
JIC-161914A1	P-UB-10	75 X 105 mm	278.53
JIC-162976A1	P-UB-10	70 X 95 mm	244.54
JIC-164183A1	P-UB-10	85 X 125 mm	250.64

CASE

## REPLACEMENT KITS FOR CASE EQUIPMENT

CASE

Kit Number	Code (Pg. xviii)	Rod X Bore Size	List Price
JIC-164493A1	P-UB-10	75 X 100 mm	\$ 174.78
JIC-164494A1	P-UB-10	80 X 115 mm	279.56
JIC-175251A1	P-UB-10	1-1/2 X 2-3/4	97.17
JIC-179011A1	P-UB-10,12	2-1/2 X 5-1/2	139.02
JIC-182218A1	P-UB-10,12	2-1/4 X 4-1/2	89.50
JIC-183286A1	P-U-10	1-1/4 X 2-1/2	45.79
JIC-191747A1	P-UB-10,12	2 X 3-3/4	95.09
JIC-1980161C1	P-UB-10	2 X 3-1/2	51.92
JIC-1980181C2	P-UB-10	2 X 3-3/4	66.95
JIC-1980412C2	P-UB-10	2-1/2 X 5-1/2	193.37
JIC-198376A2	P-UB-10	1-3/4 X 2-1/2	50.12
JIC-1986823C2	P-UB-10	3-1/2 X 6	148.71
JIC-1986856C2	P-UB-10	2 X 4-1/2	84.94
JIC-1986920C2	P-UB-10	4 X 7	171.34
JIC-1994527C2	P-UB-10	2-3/4 X 5-1/2	176.05
JIC-201501A1	I-U-10	40 X 70 mm	24.08
JIC-234844A1	P-UB-10,12	2-1/4 X 4-1/4	92.90
JIC-235933A1	P-U-10	1-3/4 X 3-1/2	31.13
JIC-250741A1	P-UB-10	1-3/4 X 3-1/2	64.23
JIC-297895A1	P-UB-10	2-3/4 X 3-3/4	69.54
JIC-310478A1	P-UB-10	1-3/4 X 3	58.83
JIC-358013A1	P-UB-10	2-1/4 X 3-3/4	52.18
JIC-360979A1	P-UB-10	2-1/4 X 4	52.82
JIC-360982A1	P-UB-3	2-1/2 X 4-1/2	66.42
JIC-360984A1	P-UB-3	3 X 5	79.41
JIC-381101A1	P-UB-10	2-1/4 X 4-1/8	91.27
JIC-55355C91	I-OB-10	1 X 2-1/2	69.81
JIC-700710260	P-U-10	1-3/8 X 3	77.16
JIC-84154317	P-UB-10	2-1/4 X 5	64.79
JIC-84155085	P-UB-10	2 X 4-1/4	63.76
JIC-8605262	P-UB-10	3 X 4-3/4	96.93
JIC-8605263	P-UB-10	3 X 5-3/4	84.39
JIC-86613643	P-UB-11	1-3/8 X2-3/4	47.48
JIC-86613644	P-UB-11	1-1/2 X 2-1/4	32.30
JIC-86614269	P-U-11	1-1/2 X 3	32.31
JIC-86631598	P-UB-11	1-1/2 X 2-2/2	32.48
JIC-86988474	P-U-10	40 mm X 60 mm	34.53
JIC-86988481	P-U-10	35 mm X 65 mm	39.36
JIC-86988486	P-U-10	40 mm X 65 mm	31.01
JIC-86988490	P-U-10	35 mm X 70 mm	50.74
JIC-86988494	P-U-10	35 mm X 75 mm	47.58
JIC-87363451	P-UB-10	1-3/4 X 3-1/4	117.22
JIC-87367212	P-UB-10,12	2-3/4 X 5-1/2	119.63
JIC-87367429	I-UB-10	2-1/2 X 5-1/2	139.01
JIC-87418297	I-UB-10	2-1/2 X 5-1/4	180.19

Kit Number	Code (Pg. xviii)	Rod X Bore Size	List Price
JIC-87428866	P-UB-10	2-1/2 X 90 mm	\$ 33.79
JIC-87428869	P-UB-10	2 X 2-3/4	60.81
JIC-87428874	P-UB-10	2-1/2 X 135 mm	154.82
JIC-87432407	P-UB-10	2 X 3-1/2	44.04
JIC-87432412	P-UB-10	1-3/4 X 3-1/4	45.78
JIC-87434291	P-UB-3	2-1/2 X 4-1/2	66.42
JIC-87434292	P-UB-10	2-1/4 X 4	52.82
JIC-87434293	P-UB-3	3 X 5	79.41
JIC-87440117	I-UB-10	2-1/4 X 4-1/2	45.85
JIC-87442965	P-UB-10	3 X 6	84.39
JIC-87445307-NP	P-UB-10	2 X 110 mm	62.20
JIC-87529743	P-UB-10	3-1/2 X 6-1/2	171.32
JIC-87530718	P-UB-10	3 X 5-1/4	105.29
JIC-87608671	P-UB-10	2 X 2-3/4	41.48
JIC-87633295	P-UB-10	2-1/2 X 4-1/2	102.86
JIC-87651309	P-UB-10	2 X 3-3/4	51.72
JIC-87653283	P-UB-10	2 X 3	33.97
JIC-907001	P-N-5	2 X 2	25.53
JIC-907001	TRACK ADJUSTER		25.53
JIC-A43296	I-U-10	1-1/4 X 2-1/8	21.77
JIC-A44644	I-O-3	3/4 X 1-1/2	10.38
JIC-D143215	I-U-10	2 X 4	30.10
JIC-D148100	I-U-13	3/4 X 1-1/2	22.76
JIC-D37360	I-U-9	1-1/2 X 2-1/2	40.91
JIC-D37361	I-U-9	1-1/2 X 2	29.95
JIC-D42867	I-U-1	1-1/4 ROD	19.12
JIC-D42869	I-U-1	1-1/2 ROD	20.62
JIC-D42870	I-U-1	1-1/2 ROD	20.47
JIC-D42872	I-U-1	1-3/4 ROD	15.33
JIC-D42873	I-U-1	1-3/4 ROD	21.01
JIC-D42874	I-U-1	2 ROD	16.35
JIC-D42875	I-U-1	1-3/4 ROD	16.26
JIC-D42876	I-U-1	2 ROD	19.32
JIC-D42877	I-U-1	2-1/4 ROD	15.20
JIC-D42878	P-U-1	2-1/4 ROD	18.66
JIC-D47651	I-U-1	2 ROD	16.91
JIC-D47896	I-U-1	1-1/2 ROD	16.51
JIC-D50279	I-U-9	3 X 5	66.50
JIC-D61006	P-U-10	1 X 2	7.71
JIC-D83184	I-U-11	3/4 X 1-1/2	16.69
JIC-G101021	P-U-10	1-1/4 X 2-1/8	22.99
JIC-G102401	USE JIC-G105545		
JIC-G102402	USE JIC-G105546		
JIC-G102403	USE JIC-G105547		
JIC-G102404	USE JIC-G105548		



# REPLACEMENT KITS FOR CASE EQUIPMENT

Kit Number	Code (Pg. xviii)	Rod X Bore Size	List Price
JIC-G102405	USE JIC-G105549		
JIC-G102406	USE JIC-G105550		
JIC-G102407	USE JIC-G105551		
JIC-G102408	P-U-10	1-3/4 X 4	\$ 45.05
JIC-G102410	P-U-10	1-3/4 X 3-1/2	42.45
JIC-G102411	USE JIC-G105555		
JIC-G102412	USE JIC-G105556		
JIC-G105206	P-UB-10	1-1/2 X 2-3/4	67.58
JIC-G105502	P-UB-10	1-1/2 X 3	37.90
JIC-G105503	P-UB-9	1-1/2 X 2	37.17
JIC-G105505	P-UB-9	1-1/2 X 2-1/2	35.33
JIC-G105507	P-UB-10	1-1/4 X 2-1/2	26.36
JIC-G105508	P-U-9	1-3/4 X 3-1/2	48.49
JIC-G105510	P-UB-10	1-1/4 X 3	26.93
JIC-G105512	P-UB-9	1-1/2 X 3	52.15
JIC-G105513	P-UB-9	2-1/2 X 4-1/2	91.03
JIC-G105514	P-UB-9	2-1/2 X 5-1/2	91.25
JIC-G105515	P-UB-9	2-1/2 X 5	77.48
JIC-G105516	P-UB-9	3 X 6	95.29
JIC-G105517	P-UB-9	2 X 4	54.98
JIC-G105518	P-U-9	1-3/4 X 3-1/2	44.55
JIC-G105519	P-UB-9	1-3/4 X 4	49.76
JIC-G105520	P-UB-9	2-1/4 X 4-1/2	88.28
JIC-G105521	P-UB-9	2 X 3-1/2	45.75
JIC-G105523	P-UB-9	1-3/4 X 3	49.91
JIC-G105524	P-UB-9	1-3/4 X 3	57.47
JIC-G105525	P-UB-9	2 X 4-1/2	73.53
JIC-G105526	P-UB-9	2 X 4	54.90
JIC-G105527	P-UB-9	2 X 3-1/2	52.45
JIC-G105528	P-UB-8	1-3/4 X 3-1/4	47.83
JIC-G105529	P-UB-9	1-3/4 X 3-1/2	41.78
JIC-G105530	P-UB-9	2-1/4 X 5	91.91
JIC-G105531	P-UB-9	3 X 5	88.67
JIC-G105545	P-UB-10	2 X 4	53.06
JIC-G105546	P-UB-10	2 X 3-1/2	46.94
JIC-G105547	P-UB-10	1-3/4 X 3-1/4	44.90
JIC-G105548	P-UB-10	1-1/2 X 3	39.05
JIC-G105549	P-UB-10	1-3/4 X 3	49.69
JIC-G105550	P-UB-10	1-1/2 X 2-1/2	29.30
JIC-G105551	P-UB-10	1-1/4 X 2-1/2	33.21
JIC-G105552	P-UB-10	1-3/4 X 4	46.78
JIC-G105553	P-UB-10	2 X 3-1/4	49.22
JIC-G105555	P-UB-10	1-1/2 X 3-1/2	36.74
JIC-G105556	P-UB-10	2-1/4 X 4	50.75
JIC-G105557	P-UB-10	2-1/4 X 4-1/2	65.36

Kit Number	Code (Pg. xviii)	Rod X Bore Size	List Price
JIC-G105560	P-UB-10	2-1/2 X 4-1/2	\$ 48.77
JIC-G105561	P-UB-10	2-1/2 X 4	44.55
JIC-G105562	P-UB-10	2-3/4 X 5	73.20
JIC-G105563	P-UB-10	2-1/2 X 3-1/2	49.18
JIC-G105566	P-UB-9	2-3/4 X 5-1/2	147.29
JIC-G109417	P-UB-10	1-3/4 X 3-1/4	44.90
JIC-G109418	P-UB-10	1-1/2 X 3	29.45
JIC-G109421	P-UB-9	2 X 4	45.05
JIC-G109423	P-UB-10	2 X 4	49.69
JIC-G109424	P-UB-10	2-1/2 X 4	51.32
JIC-G109452	P-UB-10	1-1/2 X 3	29.65
JIC-G109453	P-UB-10	2 X 3-1/2	43.95
JIC-G109454	P-UB-9	2 X 3-1/2	34.85
JIC-G109456	P-UB-10	1-1/2 X 2-1/2	29.30
JIC-G109458	P-UB-10	1-1/2 X 2-1/2	23.43
JIC-G109460	P-UB-10	1-3/4 X 3	32.23
JIC-G109462	P-UB-9	1-3/4 X 3	36.31
JIC-G109465	P-UB-10	2 X 3-1/4	51.98
JIC-G109470	P-UB-9	1-3/4 X 3-1/2	38.50
JIC-G109471	P-UB-10	1-3/4 X 3-1/2	42.84
JIC-G109472	P-UB-10	1-1/2 X 3-1/2	40.50
JIC-G109475	P-UB-10	1-1/4 X 2-1/2	33.21
JIC-G109476	P-UB-10	1-1/4 X 2-1/2	31.93
JIC-G109484	P-UB-9	1-1/2 X 2-1/2	41.75
JIC-G109498	P-UB-9	2-1/2 X 4-1/2	83.96
JIC-G109499	P-UB-9	2-1/2 X 5	102.13
JIC-G109500	P-UB-9	3 X 5-1/2	131.38
JIC-G109501	P-UB-9	2-1/4 X 5	85.03
JIC-G109502	P-U-9	3 X 5	87.46
JIC-G109503	P-U-10	2-1/2 X 4-1/2	49.06
JIC-G109504	P-UB-10	2-1/2 X 3-1/2	43.39
JIC-G109505	P-UB-10	2-1/4 X 4	46.61
JIC-G110045	P-U-10	1-1/2 X 2-3/4	62.71
JIC-G110046	P-UB-10	2-1/2 X 3-1/2	43.01
JIC-G110047	P-UB-10	1-1/4 X 2-3/4	40.79
JIC-G110048	P-UB-10	1-1/4 X 3	30.54
JIC-G110049	P-UB-10	1-3/4 X 3	38.47
JIC-G110050	P-UB-10	1-1/2 X 3	33.95
JIC-G110053	P-UB-10	1-3/4 X 3-1/4	35.29
JIC-G110055	P-UB-10	1-1/4 X 2-1/2	50.08
JIC-G110526	P-UB-10	3 X 6	90.32
JIC-G110537	P-UB-10	2 X 4-1/4	53.25
JIC-G110582	P-UB-10	2-1/2 X 5	52.08
JIC-G110583	P-UB-10	2-1/4 X 5	133.55
JIC-G110621	P-UB-10	1-3/4 X 3-1/2	40.07

CASE

# REPLACEMENT KITS FOR CASE EQUIPMENT

CASE

Kit Number	Code (Pg. xviii)	Rod X Bore Size	List Price
JIC-G32184	P-U-9	2-1/2 X 5	\$ 68.86
JIC-G32228	P-U-9	1-3/4 X 3-1/2	39.76
JIC-G32293	P-U-9	2 X 3-1/2	40.26
JIC-G32294	P-U-9	1-1/2 X 2-1/2	35.93
JIC-G32295	P-U-9	1-1/4 X 2-1/2	45.16
JIC-G32299	P-U-9	2 X 4	51.90
JIC-G32616	P-U-9	2 X 4	49.91
JIC-G32617	P-U-9	1-3/4 X 4	51.99
JIC-G32668	P-U-9	3 X 5	76.65
JIC-G32695	P-U-9	2 X 4-1/2	75.71
JIC-G32696	P-U-9	2-1/4 X 5	75.24
JIC-G32827	USE JIC-G105505		
JIC-G33141	USE JIC-G105507		
JIC-G33823	P-U-9	2-1/2 X 5-1/2	81.96
JIC-G34172	USE JIC-G105507		
JIC-G34205	USE JIC-G105510		
JIC-G34277	USE JIC-G109458		
JIC-G34332	USE JIC-G105512		
JIC-G34333	USE JIC-G105513		
JIC-G34334	P-U-9	3 X 5	94.50
JIC-G34335	P-U-9	2 X 4	52.99
JIC-G34536	USE JIC-G105514		
JIC-G34537	USE JIC-G105515		
JIC-G34569	USE JIC-G105516		
JIC-G34594	P-U-9	2 X 4	53.60
JIC-G34622	P-U-9	1-3/4 X 3-1/2	44.55
JIC-G34624	P-U-9	1-3/4 X 3-1/2	42.84
JIC-G34626	P-U-9	1-3/4 X 4	53.90
JIC-G34628	USE JIC-G105520		
JIC-G34630	USE JIC-G105521		
JIC-G34631	P-U-9	1-3/4 X 3-1/2	42.84
JIC-G34634	USE JIC-G105523		
JIC-G34636	P-U-9	2-1/4 X 4	59.90
JIC-G34642	USE JIC-G105524		
JIC-G34643	P-U-9	1-3/4 X 3	45.91
JIC-G34644	USE JIC-G105525		
JIC-G34646	P-U-9	1-1/2 X 3.5	38.55
JIC-G34647	USE JIC-G105526		
JIC-G34648	P-U-9	2 X 3-1/2	48.50
JIC-G34651	USE JIC-G105527		
JIC-G34652	P-U-9	1-1/2 X 3-1/2	39.20
JIC-G34653	USE JIC-G105528		
JIC-G34655	P-U-9	1-3/4 X 3-1/2	40.26
JIC-G34656	P-U-10	1-1/2 X 3	35.99
JIC-G34752	USE JIC-G105530		

Kit Number	Code (Pg. xviii)	Rod X Bore Size	List Price
JIC-G34753	USE JIC-G105531		
JIC-G34807	P-U-10	1 X 2-1/2	\$ 16.48
JIC-G34819	P-U-10	1-1/4 X 2-1/8	23.65
JIC-G34827	P-U-9	2-1/4 X 4	59.90
JIC-G35374	P-U-10	1 X 3	25.12
JIC-G35378	P-U-10	1 X 2-1/2	15.90
JIC-H52704	P-OB-3	1 X 2	16.09
JIC-H53041	P-OB-1	3-3/4 Rod Kit	21.85
JIC-LQU0245	P-UB-10	70 mm X 100 mm	129.64
JIC-A5349616	P-U-10	95 X 125 mm	103.79
JIC-LZ00361	P-UB-10	85 X 120 mm	132.39
JIC-LZ00440	P-UB-10	115 mm X 170 mm	299.39
JIC-LZ00442	P-UB-10	90 mm X 125 mm	155.85
JIC-LZ00443	P-UB-10	105 mm X 145 mm	138.66
JIC-LZ00444	P-UB-10	90 mm X 130 mm	150.19
JIC-LZ00445	P-UB-10	85 mm X 120 mm	134.46
JIC-LZ00446	P-UB-10	95 mm X 135 mm	115.70
JIC-LZ00447	P-UB-10	80 mm X 115 mm	92.83
JIC-LZ00448	P-UB-10	70 mm X 105 mm	119.45
JIC-LZ00449	P-UB-10	80 mm X 115 mm	108.69
JIC-LZ00450	P-UB-10	65 mm X 95 mm	77.73
JIC-LZ00451	I-UB-10	80 mm X 115 mm	112.93
JIC-LZ00452	P-UB-10	90 mm X 125 mm	185.20
JIC-LZ00453	P-UB-10	75 mm X 105 mm	112.89
JIC-LZ00455	P-UB-10	75 mm X 105 mm	140.26
JIC-LZ00456	P-UB-10	65 mm X 120 mm	69.42
JIC-LZ00457	P-UB-10	70 mm X 110 mm	73.36
JIC-LZ00477	P-UB-10	100 X 145 mm	299.20
JIC-LZ00476	P-UB-10	105 X 150 mm	406.61
JIC-LZ00478	P-UB-10	120 X 170 mm	347.03
JIC-LZ00482	P-UB-10	105 mm X 150 mm	126.72
JIC-LZ00483	P-UB-10	100 mm X 145 mm	112.99
JIC-LZ00484	P-UB-10	120 X 170 mm	347.03
JIC-LZ00522	P-UB-10	70 X 95 mm	244.54
JIC-LZ00533	P-UB-10	90 X 130 mm	484.06
JIC-LZ00539	P-UP-10	75 X 100 mm	166.49
JIC-N14638	P-U-10	1 X 2	33.95
JIC-N14639	P-U-10	1-1/4 X 2	41.64
JIC-S300163	I-U-10	2 X 4	23.18
JIC-S301013	I-U-10	2-1/2 X 5	58.93
JIC-S301442	I-U-10	2 X 4	35.16
JIC-S92713	P-U-9	2-1/2 X 5	74.55
JIC-S92714	P-U-9	2-1/2 X 5-1/2	82.20
JIC-S92724	P-U-9	2-3/4 X 5-1/2	105.65





# REPLACEMENT KITS FOR CASE EQUIPMENT

**NOTE:** Case part numbers are used as a reference only. We do not imply that these kits are original REPLACEMENT PARTS.

## O-RINGS

Part Number	Min. Pkg	List Price
JIC-14461280	20	\$ 0.63
JIC-14466580	10	1.11
JIC-218-5002	50	0.15
JIC-218-5004	50	0.21
JIC-218-5009	20	0.37
JIC-22409R1	20	0.51
JIC-235-5234	20	0.57
JIC-237-6004	50	0.21
JIC-237-6006	50	0.21
JIC-237-6008	50	0.24
JIC-237-6010	50	0.25
JIC-237-6012	50	0.31
JIC-237-6016	20	0.41
JIC-237-6020	20	0.51
JIC-237-6024	10	0.74
JIC-238-5115	50	0.09
JIC-238-5116	50	0.09
JIC-238-5210	25	0.26
JIC-238-5214	50	0.16
JIC-238-5224	20	0.52
JIC-238-5226	20	0.38
JIC-238-5228	20	0.41
JIC-238-5230	20	0.48
JIC-238-5232	20	0.51
JIC-238-5234	20	0.57
JIC-238-5246	10	1.08
JIC-238-5247	10	1.11
JIC-238-5437	5	2.39
JIC-238-6011	50	0.10
JIC-238-6012	50	0.10

## O-RINGS

Part Number	Min. Pkg	List Price
JIC-238-6014	50	\$ 0.11
JIC-238-6016	50	0.14
JIC-238-6018	50	0.15
JIC-238-6021	50	0.25
JIC-238-6025	50	0.28
JIC-238-6029	20	0.35
JIC-238-6218	19	0.40
JIC-238-6231	12	0.89
JIC-238-7113	15	0.64
JIC-307916R1	10	0.98
JIC-343909R1	20	0.51
JIC-343921R1	20	0.64
JIC-343923R1	20	0.77
JIC-369375R1	50	0.15
JIC-510828	10	1.21
JIC-70923823	10	1.25
JIC-86977728	50	0.09
JIC-A14515	20	0.31
JIC-A17526	50	0.07
JIC-A23316	10	1.11
JIC-A27365	50	0.09
JIC-A27384	10	1.25
JIC-A27410	50	0.07
JIC-A27507	10	0.76
JIC-A27510	10	1.08
JIC-A27994	20	0.63
JIC-A28239	5	1.70
JIC-A28318	20	0.48
JIC-A29456	50	0.18
JIC-A30095	20	0.57

## O-RINGS

Part Number	Min. Pkg	List Price
JIC-A30097	50	\$ 0.19
JIC-A30915	20	0.21
JIC-A47696	50	0.26
JIC-A55800	5	1.46
JIC-A60212	20	0.28
JIC-A61429	20	0.26
JIC-A7156	20	0.52
JIC-A7982	50	0.16
JIC-D26115	20	0.38
JIC-D26820	20	0.22
JIC-D27878	20	0.28
JIC-D31968	20	0.42
JIC-D36183	10	1.25
JIC-F62075	50	0.10
JIC-G100444	13	1.08
JIC-G100710	13	1.25
JIC-G100713	13	0.95
JIC-G100959	3	3.25
JIC-G10347	10	1.21
JIC-G105104	5	2.54
JIC-G105183	5	1.89
JIC-G15457	20	0.67
JIC-G46889	20	0.60
JIC-H436690	20	0.55
JIC-H743591	10	0.76
JIC-N13688	12	0.89
JIC-S6499	20	0.28
JIC-S6573	50	0.29
JIC-T52486	19	0.45

CASE

# REPLACEMENT PARTS FOR CASE EQUIPMENT

**NOTE:** Case part numbers are used as a reference only. We do not imply that these kits are original REPLACEMENT PARTS.

## BACK-UP RINGS

Part Number	Min. Pkg.	List Price
JIC-A35884	13	\$ 0.65
JIC-A45035	18	0.46
JIC-A62070	8	0.65
JIC-B92639	3	2.63
JIC-D28497	1	1.90
JIC-D28498	1	3.40
JIC-D28499	1	1.64
JIC-D28500	1	3.67
JIC-D38858	6	1.23
JIC-D39539	1	2.22
JIC-D42453	3	3.10
JIC-G109033	2	4.35
JIC-G109297	10	0.99
JIC-G109298	7	1.12
JIC-G109300	4	2.18
JIC-G32105	3	2.86
JIC-G32122	6	1.23
JIC-G32126	5	1.43
JIC-G32129	7	1.12
JIC-G32176	5	1.77
JIC-G32284	3	2.48
JIC-G32626	9	0.81
JIC-G32649	2	4.22
JIC-G34260	3	3.60
JIC-H745760	7	1.14
JIC-H754606	6	1.36
JIC-S92644	3	3.25
JIC-S99881	2	4.13

## U-SEALS

Part Number	Rod Diameter	List Price
JIC-G34803	1	\$ 5.01
JIC-G35372	1	4.52
JIC-D36968	1-1/4	5.24
JIC-D60999	1-1/4	5.74
JIC-D36969	1-1/2	5.91
JIC-G107921	1-1/2	11.51
JIC-H436694	1-3/8	7.22
JIC-1542999C1	1-3/4	12.95
JIC-D36970	1-3/4	6.73
JIC-G107922	1-3/4	7.92
JIC-D36971	2	7.38
JIC-G107923	2	14.86
JIC-1986572C1	2-1/4	8.50
JIC-D39359	2-1/4	8.50
JIC-1542929C1	2-1/4	15.81
JIC-1542931C1	2-1/2	15.40
JIC-D45571	2-1/2	9.59
JIC-S220100	2-3/4	10.14
JIC-1543008C1	2-3/4	15.73
JIC-D45572	3	10.63
JIC-G109054	3	16.23
JIC-A137343	3-1/2	12.50
JIC-S118038	3-1/2	40.74
JIC-G109056	4	63.56

## WIPERS

Part Number	Rod Diameter	List Price
JIC-A44651	3/4	\$ 1.08
JIC-D60997	1	2.65
JIC-H746297	1	3.40
JIC-D27705	1-1/4	5.63
JIC-D95141	1-1/4	12.34
JIC-D27706	1-1/2	2.29
JIC-D95142	1-1/2	12.61
JIC-226847A1	1-3/8	12.48
JIC-H436692	1-3/8	3.06
JIC-403845R1	1-3/4	13.62
JIC-D27432	1-3/4	5.06
JIC-D95143	1-3/4	13.62
JIC-D27380	2	6.99
JIC-D95144	2	14.14
JIC-D39360	2-1/4	4.19
JIC-D43162	2-1/4	4.19
JIC-D95145	2-1/4	15.08
JIC-G108712	2-1/4	15.82
JIC-D95149	2-3/8	12.97
JIC-D95146	2-1/2	17.12
JIC-193965C91	2-3/4	19.39
JIC-D95147	2-3/4	19.39
JIC-H215202	2-3/4	6.34
JIC-D46180	3	5.02
JIC-D95148	3	19.93
JIC-L104363	3-1/4	19.29
JIC-S92653	3-1/2	26.60
JIC-S97854	3-1/2	26.60
JIC-S108245	4	37.46

CASE

## REPLACEMENT PARTS FOR CASE EQUIPMENT

**NOTE:** Case part numbers are used as a reference only. We do not imply that these kits are original REPLACEMENT PARTS.

### WEAR RINGS

Part Number	O.D. X Width	List Price
JIC-G102864	1-3/8 X 0.98	\$11.56
JIC-G102424	1-5/8 X 0.98	5.76
JIC-G102425	1-7/8 X 0.98	5.72
JIC-G101533	2-1/8 X 0.98	6.12
JIC-G101837	2-1/8 X 3/8	4.01
JIC-G34818	2-1/8 X 3/8	4.01
JIC-G102426	2-3/8 X 1.48	12.32
JIC-G1346476C1	2-3/8 X 0.98	4.44
JIC-G100714	2-1/2 X 3/8	4.14
JIC-G34805	2-1/2 X 3/8	4.14
JIC-G109908	2-5/8 X 0.98	4.33
JIC-G102427	2-5/8 X 1.48	10.98
JIC-G105187	2-3/4 X 3/8	4.20
JIC-G102428	2-7/8 X 1.48	11.40
JIC-H436691	3 X 1/4	3.86
JIC-G100449	3 X 3/8	4.27
JIC-G32033	3 X 3/8	4.27
JIC-A17360	3 X 3/4	4.91
JIC-G102429	3-1/8 X 1.48	13.16
JIC-S109445	3-1/4 X 3/8	4.39
JIC-G100711	3-1/2 X 3/8	4.42
JIC-S104133	3-3/4 X 1/2	4.49
JIC-G100448	4 X 3/8	5.60
JIC-A63393	4 X 5/8	5.27
JIC-A17341	4 X 1	5.76
JIC-G101996	4-1/2 X 3/4	5.15
JIC-1-9854T1	5 X 0.622	5.27
JIC-G102090	5 X 3/4	5.27
JIC-1980266C1	5-1/2 X 3/4	5.37
JIC-S97856	6-1/2 X 1/2	6.19

### BUFFER RINGS

Part Number	Rod Diameter	List Price
JIC-G109092	1-1/4	\$ 4.19
JIC-G109093	1-1/2	14.42
JIC-1542998C1	1-3/4	16.37
JIC-G109094	1-3/4	5.49
JIC-1542928C1	2-1/4	20.26
JIC-G109086	2-1/4	6.72
JIC-G107998	2-1/2	7.31
JIC-1542930C1	2-1/2	22.17
JIC-1543007C1	2-3/4	24.11

### ROD BEARINGS

Part Number	Rod Diameter	List Price
JIC-G34302	1-1/2	\$ 5.76
JIC-G34621	1-3/4	5.72
JIC-G34322	2	6.12
JIC-G34620	2-1/4	12.32
JIC-G34307	2-1/2	10.98
JIC-S220099	2-3/4	11.40
JIC-G34313	3	13.16

## REPLACEMENT PARTS FOR CASE EQUIPMENT

**NOTE:** Case part numbers are used as a reference only. We do not imply that these kits are original REPLACEMENT PARTS.

### PISTON SEALS

Part Number	Bore Diameter	List Price
JIC-D60995	2	\$ 5.69
JIC-A61430	2-1/8	10.66
JIC-191319A1	2-1/2	13.35
JIC-G100712	2-1/2	21.58
JIC-G102289	2-1/2	9.86
JIC-G33140	2-1/2	8.84
JIC-258546A2	2-3/4	16.75
JIC-G102288	3	25.72
JIC-G32034	3	15.17
JIC-H120188	3	5.25
JIC-G102287	3-1/4	22.85
JIC-G100709	3-1/2	9.88
JIC-G102286	3-1/2	22.11
JIC-G1340764C1	3-3/4	23.12
JIC-G102285	4	22.85
JIC-G110531	4-1/4	25.18
JIC-G101994	4-1/2	25.85
JIC-1986753C1	5	27.91
JIC-140968A1	5-1/2	16.29
JIC-87367210	5-1/2	93.40
JIC-S228607	6-1/2	43.05
JIC-1346359C1	8	48.96

### VEE SETS

Part Number	O.D.	List Price
<b>SINGLE ACTING VEE SETS WITH NO CENTER BEARING</b>		
JIC-G33186	3-1/4	\$ 14.64
JIC-D47205	4-1/2	28.42
JIC-D47207	5-1/2	24.95
JIC-SVS5.5P	5-1/2	24.95
JIC-D49321	6	30.00
JIC-SVS6.0P	6	30.00
<b>DOUBLE ACTING VEE SETS WITH CENTER BEARING</b>		
JIC-G33201	2	\$ 19.89
JIC-G33193	2-1/2	20.35
JIC-G33151	3	20.85
JIC-G33237	3-1/2	23.09
JIC-G33239	4	25.19
JIC-DTVS4.5P	4-1/2	51.78
JIC-D36906	5	41.54
JIC-D47206	5	41.54

CASE

# REPLACEMENT SEAL KITS FOR CATERPILLAR® EQUIPMENT\*

Replacement Seal Kits By Machine Type

## Table of Contents

Machine Type		Page
<b>Agricultural Tractors</b>	65, 65B, 75, 65C, 65D, 70C, 65E, 69D, 73D, 75C, 75D, 75E, 75G, 85C	206
<b>Backhoe Loaders</b>	416, 416B, 416C, 416D, 416E, 420D, 420E, 426, 426B, 426C, 428, 428B, 428C, 430D, 430E, 436, 436B, 436C, 438, 438B, 438C, 446, 446B, 446D	206 - 228
<b>Crawler Dozers</b>	3P, 3S, 4S, 5A, 5S, 6, 6S, 7A, 7S, 7U, 7SU, 8A, 8B, 8D, 8R, 8S, 8U, 9B, 9R, 9S, 9U, D2, D3, D3 LGP, D3B, D3C, D3G, D3K XL & LGP, D4B, D4C, D4D, D4E, D4G, D4H, D4K XL & LGP, D4L, D4TSKH, D5, D5B, D5C, D5E, D5G, D5H, D5K XL & LGP, D5M, D5N, D5TSKH, D6, D6 LGP, D6B, D6C, D6D, D6E, D6G, D6H, D6K LGP, D6K XL, D6M, D6N, D6R, D6T, D7, D7 LGP, D7A, D7B, D7C, D7D, D7E, D7F, D7G, D7H, D7R, D8, D8H, D8K, D8L, D8N, D8R, D8T, D9D, D9G, D9H, D9L, D9N, D9R, D9T, D10, D10N, D10R, D10T, D11N, D11R	228 - 253
<b>Crawler Loaders</b>	931, 931B, 931C, 933, 933C, 933E, 933F, 933G, 935B, 935C, 939, 939C, 941, 941B, 943, 943B, 951, 951B, 951C, 953, 953B, 953C, 953D, 955, 955C, 955E, 955F, 955H, 955K, 955L, 963, 963B, 963C, 963D, 973, 973C, 977, 977D, 977H, 977K, 977L, 983	253 - 266
<b>Dump Trucks - Articulated</b>	D25C, D25D, D30C, D30D, D35C, D35HP, D35HPC, D40D, D250B, D250D, D250E, D300B, D300B AG, D300B CANE H, D350B, D350C, D350D, D350E, D350E, D400, D400D, D400E	266 - 269
<b>Excavators</b>	215, 215B, 215C, 215D, 219, 219D, 225, 225B, 225D, 227, 229, 229D, 231D, 235, 235 FS, 235B, 235C, 235C FS, 235D, 245 FS, 245, 245B, 245B FS, 245D, 302.5, 302.5C, 303 C CR, 303.5, 303.5C CR, 303CR, 304 C CR, 304.5, 304CR, 305 C CR, 305CR, 307, 307B, 307C, 308B, 308C CR, 311, 311B, 311C U, 312, 312B, 312BL, 312C, 312CL, 313B, 314C LCR, 315, 315B, 315B L, 315C, 315C L, 315D L, 315L, 317, 317B, 317BL, 317N, 318B, 318BL, 318C, 318C L, 318C LN, 320, 320B, 320BL, 320C, 320C L, 320C LN, 320C LRR, 320C LU, 320C S, 320C U, 320C, 320CL, 320C6, 320D, 320D L, 320D LN, 320D LRR, 320D RR, 320L, 320N, 320S, 321B, 321C LCR, 321D LCR, 322, 322B, 322BL, 322C, 322C FM LGP, 322C L, 322C LN, 322L, 322N, 324D L, 325, 325B, 325BL, 325C, 325C L, 325C LN, 325D, 325D L, 325D LN, 325L, 325N, 330, 330B, 330BL, 330C, 330C L, 330C LN, 330D, 330D L, 330D N, 330L, 336D, 336D L, 336D LN, 345B, 345BL, 345C, 345C L, 345D L, 350, 350L, 365, 365B, 375, 375L, E70B, E110, E110B, E120, E120B, E180, EL180, E200B, EL200B, E240, EL240, E240B, EL240B, E300, EL300, E300B, EL300B	269 - 338
<b>Excavators - Front-Shovel</b>	5080, 5110, 5230, 5230B	338
<b>Excavators - Wheel</b>	M315, M316, M318, M320	338 - 339
<b>Forestry - Tree Harvesters</b>	518	339
<b>Integrated Toolcarriers</b>	IT12, IT12B, IT12F, IT14B, IT14C, IT14F, IT14G, IT18, IT18B, IT18F, IT24F, IT28, IT28B, IT28F, IT28G, IT38F, IT38G, IT62G	339 - 344
<b>Landfill Compactors</b>	816, 816B, 816F, 826B, 826C, 826G, 836, 836C	344 - 345
<b>Loaders - Skid Steer</b>	226, 226B, 226B2, 236, 236B, 236B2, 242, 242B, 242B2, 246, 246B, 246C, 252B, 252B2, 262, 262B, 262C, 268B	345 - 355
<b>Loaders - Wheel</b>	902, 904, 906, 908, 910, 910E, 910F, 914, 914G, 916, 918F, 920, 924, 924F, 924G, 924Gz, 924H, 924HZ, 926, 926E, 928F, 928G, 928HZ, 930, 930G, 930H, 930R, 930T, 936, 936E, 936F, 938F, 938G, 938H, 944, 944A, 950, 950B, 950E, 950F, 950G, 950H, 960F, 960G, 962G, 966, 966A, 966B, 966C, 966D, 966E, 966F, 966G, 966H, 966R, 970F, 972G, 972H, 980, 980B, 980C, 980F, 980G, 980H, 988, 988B, 988F, 988G, 990, 992, 992B, 992C, 992D, 994D, G910, G916, G926, G936	355 - 374
<b>Motor Graders</b>	12, 12E, 12F, 12G, 12H, 14, 14D, 140, 14E, 14G, 14H, 16, 16G, 16H, 24H, 112, 112E, 112F, 120, 120B, 120G, 120H, 130G, 135H, 140B, 140G, 140H, 143H, 160G, 160H, 163H	374 - 386
<b>Off-Highway Trucks</b>	768, 768B, 768C, 769, 769B, 769C, 769D, 770, 771C, 771D, 772, 772B, 772E, 773, 773B, 773D, 773E, 773F, 775, 775B, 775D, 776, 776B, 776C, 776D, 777, 777B, 777C, 777D, 777F, 783B, 784B, 784C, 785, 785B, 785C, 786, 787B, 789, 789B, 789C, 793, 793B, 793C, 793D	386 - 393
<b>Pipelayers</b>	561B, 561C, 561D, 571A, 571F, 571G, 572C, 572D, 572E, 572F, 572G, 578, 583H, 583K, 583R, 589, 591, 594, 594H, MD7, MD8, MDW8	394
<b>Scrapers</b>	611, 613, 613B, 613C, 613SC, 615, 615C, 615SC, 621, 621B, 621E, 621F, 621G, 621R, 621S, 621SC, 623, 623B, 623E, 623F, 623G, 623SC, 623SCG, 627, 627B, 627E, 627F, 627G, 627SC, 630, 630B, 630SC, 631, 631B, 631C, 631D, 631E, 631SC, 632, 633, 633B, 633C, 633D, 633SC, 637, 637B, 637D, 637E, 637SC, 639D, 639SC, 641, 641B, 641SC, 650, 650B, 651, 651B, 651C, 651E, 651SC, 657, 657B, 657E, 657SC, 660, 666B, 660B, 666, 660SC, 666SC, J621	394 - 410
<b>Skidders</b>	508, 515, 525, 517, 518, 518C, 520D, 522C, 520C, 525B, 527, 528, 528B, 530B, 535B, 545, FB508, FB518	410 - 412
<b>Soil Compactors</b>	815, 815B, 815F, 815S, 825, 825B, 825C, 825G, 835	412 - 413
<b>Telehandlers</b>	TH62, TH63, TH82, TH83	413
<b>Wheel Dozers</b>	814, 814B, 814F, 814S, 824, 824B, 824C, 824S, 834S, 834U, 830M, 834, 834B, 834C	414 - 417
<b>Alpha-Numeric Kit Listing</b>		418 - 436
<b>Caterpillar® Individual Parts</b>		437 - 463

CATERPILLAR®

\*All manufacturer's names, part numbers and descriptions are used for reference purposes only. We do not imply that any part shown is the product of these manufacturers. We also do not imply that the list price shown is exactly that of the manufacturer.



## REPLACEMENT KITS FOR CATERPILLAR® EQUIPMENT

<b>Agricultural Tractors</b>							
APPLICATION	CYL #	Misc-Parts, Instructions, etc.	CODE	ROD	BORE	KIT #	List \$
<b>MODEL 65, 65B, 75</b>							
LIFT							
	9T2230		P-UB-10	2	4	CTC-1328816	92.75
	9T9517		P-UB-10	2	4	CTC-1328816	92.75
<b>MODEL 65C, 65D, 70C</b>							
LIFT							
	9T9517		P-UB-10	2	4	CTC-1328816	92.75
<b>MODEL 65E</b>							
LIFT							
	9T9517		P-UB-10	2	4	CTC-1328816	92.75
<b>MODEL 69D</b>							
STEERING							
	1100532		P-UB-10	2	3	CTC-7X2760	70.47
	9J1287		P-UB-10	2-3/8	3-3/4	CTC-7X2808	80.64
TENSIONER							
	4T4168		I-SP-10	4,6-1/2	5-3/4	CTC-8T4772	314.53
	9J4149		I-SP-10	4,6-1/2	5-3/4	CTC-8T4772	314.53
<b>MODEL 73D</b>							
LIFT							
	1163092		P-UB-3	7	8	CTC-1137478	655.52
STEERING RH							
	7J7686		P-UB-10	2-3/8	4	CTC-8T1389	47.61
TENSIONER							
	1455155		I-SP-10	5,7-1/2	8-1/4	CTC-8T9042	455.14
	9J2017		I-SP-10	5,7-1/2	8-1/4	CTC-8T9042	455.14
	9T3122		I-SP-10	5,7-1/2	8-1/4	CTC-8T9042	455.14
UNSPECIFIED APPLICATION							
	1162837		P-U-3	7	8-1/2	CTC-1417296	273.31
	1U4777		P-UB-3	7	8	CTC-1137478	655.52
	9T6081		P-U-3	7	8-1/2	CTC-1417296	273.31
	9T7204		N-N-10		2	CTC-6E4057	21.39
<b>MODEL 75C</b>							
LIFT							
	9T9517		P-UB-10	2	4	CTC-1328816	92.75
<b>MODEL 75D, 75E, 75G, 85C</b>							
LIFT							
	9T9517		P-UB-10	2	4	CTC-1328816	92.75
<b>Backhoe Loaders</b>							
APPLICATION	CYL #	Misc-Parts, Instructions, etc.	CODE	ROD	BORE	KIT #	List \$
<b>MODEL 416</b>							
BACKHOE BOOM							
	4T6878		P-UB-10	1-7/8	3-1/4	CTC-8T3589	80.81
	6E0087		P-UB-10	1-7/8	3-1/4	CTC-3E3297	98.56
	9T5219		P-UB-10	1-7/8	3-1/4	CTC-3E3297	98.56
BACKHOE BUCKET							
	4T5601		P-UB-10	2	3-1/4	CTC-7X2821	140.11
	6E0091		I-UB-10	2-1/2	3-1/2	CTC-3E3299	134.08
	9T2751		P-UB-10	2	3-1/4	CTC-7X2821	140.11
	9T7287		I-UB-10	2-1/2	3-1/2	CTC-3E3299	134.08
	9T7893		P-UB-10	2	3-1/4	CTC-7X2821	140.11
	9T7894		P-UB-10	2	3-1/4	CTC-7X2821	140.11
BACKHOE EXT STICK							
	9T2215		P-UB-10	1-1/2	3	CTC-7X2745	108.60
	9T4809		P-UB-10	1-1/2	3	CTC-7X2737	108.60
	9T7893		P-UB-10	2	3-1/4	CTC-7X2821	140.11

CATERPILLAR®





## REPLACEMENT KITS FOR CATERPILLAR® EQUIPMENT

<b>Backhoe Loaders</b>							
APPLICATION	CYL #	Misc-Parts, Instructions, etc.	CODE	ROD	BORE	KIT #	List \$
<b>MODEL 416</b>							
<b>BACKHOE STICK</b>							
	4T6877		P-UB-10	2-1/8	4	CTC-1305923	158.53
	6E0089		P-UB-10	2-1/2	4-1/4	CTC-3E3300	107.47
	9T2215		P-UB-10	1-1/2	3	CTC-7X2737	108.60
	9T5216		P-UB-10	2-1/8	4	CTC-1305923	158.53
	9T7063		P-UB-10	2-1/8	4	CTC-1305923	158.53
	9T7291		P-UB-10	2-1/2	4-1/4	CTC-3E3300	107.47
<b>BACKHOE SWING</b>							
	4T6879		P-UB-10	2-1/8	4	CTC-1305923	158.53
	6E0093		P-UB-10	2-1/8	4	CTC-1305923	158.53
<b>BACKHOE SWING LH</b>							
	4T6879		P-UB-10	2-1/8	4	CTC-8T3593	70.99
<b>BACKHOE SWING RH</b>							
	9T0529		P-UB-10	2-1/8	4	CTC-1305923	158.53
<b>LOADER BUCKET MP</b>							
	9T4006		P-UB-10	1-1/2	3	CTC-7X2737	108.60
<b>LOADER LIFT</b>							
	6E0103		P-UB-10	1-7/8	3-1/4	CTC-3E3297	98.56
	9T0415		P-UB-10	1-7/8	3-1/4	CTC-3E3297	98.56
<b>LOADER TILT</b>							
	6E0105		P-UB-10	1-7/8	3-1/4	CTC-3E3297	98.56
	9T0414		P-UB-10	1-7/8	3-1/4	CTC-8T3589	80.81
	9T4005		P-UB-10	1-7/8	3-1/4	CTC-3E3297	98.56
	9T5370		P-UB-10	1-7/8	3-1/4	CTC-3E3297	98.56
<b>STABILIZER</b>							
	9T7070		P-UB-10	2-1/8	4	CTC-8T3593	70.99
	9T7391		P-UB-10	2-1/8	4	CTC-1305923	158.53
	9T7392		P-UB-10	2-1/8	4	CTC-1305923	158.53
<b>STABILIZER LH</b>							
	4T9911		P-UB-10	2-1/8	4	CTC-1305923	158.53
	6E0097		P-UB-10	2-1/8	4	CTC-1305923	158.53
	9T7070		P-UB-10	2-1/8	4	CTC-1305923	158.53
<b>STABILIZER RH</b>							
	4T6880		P-UB-10	2-1/8	4	CTC-1305923	158.53
	6E0099		P-UB-10	2-1/8	4	CTC-1305923	158.53
	9T7069		P-UB-10	2-1/8	4	CTC-1305923	158.53
<b>STEERING</b>							
	6E5190		P-UB-10	1-7/8	3	CTC-1113301	131.00
	9T1493		P-UB-10	1-7/8	3	CTC-8T3852	192.90
<b>UNSPECIFIED APPLICATION</b>							
	1070624		P-UB-10	1-7/8	3-1/4	CTC-3E3297	98.56
	1070625		P-UB-10	1-7/8	3-1/4	CTC-3E3297	98.56
<b>MODEL 416B</b>							
<b>BACKHOE BOOM</b>							
	6E0274		P-UB-10	2-3/8	4-1/2	CTC-3E8877	177.68
<b>BACKHOE BUCKET</b>							
	1268308		I-UB-10	2-1/2	3-1/2	CTC-3E3299	134.08
	6E0275		I-UB-10	2-1/2	3-1/2	CTC-3E3299	134.08
<b>BACKHOE EXT BUCKET</b>							
	6E1964		I-UB-10	2-1/2	3-1/2	CTC-3E3299	134.08
<b>BACKHOE STICK</b>							
	1065694	Rod Bearing width- 1.25"	P-UB-10	2-1/2	4-1/2	CTC-1469860	161.26
	1097020		P-UB-10	2-1/2	4-1/2	CTC-1113300	136.57
	1097021		P-UB-10	2-1/2	4-1/2	CTC-1113300	136.57
	6E0290	Rod Bearing width- 1.25"	P-UB-10	2-1/2	4-1/2	CTC-1469860	161.26
	6E0404		P-UB-10	1-1/2	3	CTC-7X2737	108.60

**CATERPILLAR®**



## REPLACEMENT KITS FOR CATERPILLAR® EQUIPMENT

Backhoe Loaders							
APPLICATION	CYL #	Misc-Parts, Instructions, etc.	CODE	ROD	BORE	KIT #	List \$
<b>MODEL 416B</b>							
<b>BACKHOE SWING</b>							
	1166861		P-UB-10	2	4	CTC-1113302	118.96
	6E0288		P-UB-10	2	4	CTC-1113302	118.96
	6E1864		P-UB-10	2	4	CTC-1328816	92.75
<b>LOADER BUCKET MP</b>							
	9T4006		P-UB-10	1-1/2	3	CTC-7X2737	108.60
<b>LOADER LIFT</b>							
	9T0415		P-UB-10	1-7/8	3-1/4	CTC-3E3297	98.56
<b>LOADER TILT</b>							
	6E0105		P-UB-10	1-7/8	3-1/4	CTC-3E3297	98.56
	9T5490		P-UB-10	1-7/8	3-1/4	CTC-3E3297	98.56
<b>STABILIZER</b>							
	1052323		P-UB-10	2-1/8	4	CTC-1305923	158.53
	1052358		P-UB-10	2-1/8	4	CTC-1305923	158.53
	9T2993		P-UB-10	2-1/8	4	CTC-9X2400	119.16
	9T2994		P-UB-10	2-1/8	4	CTC-9X2400	119.16
<b>STABILIZER LH</b>							
	1165354		P-UB-10	2-1/8	4	CTC-8T3593	70.99
	1302364		P-UB-10	2-1/8	4	CTC-1305923	158.53
	6E0097		P-UB-10	2-1/8	4	CTC-1305923	158.53
<b>STABILIZER RH</b>							
	1165353		P-UB-10	2-1/8	4	CTC-1305923	158.53
	1302365		P-UB-10	2-1/8	4	CTC-1305923	158.53
	6E0099		P-UB-10	2-1/8	4	CTC-1305923	158.53
<b>STEERING</b>							
	6E5190		P-UB-10	1-7/8	3	CTC-1113301	131.00
<b>UNSPECIFIED APPLICATION</b>							
	1070624		P-UB-10	1-7/8	3-1/4	CTC-3E3297	98.56
	1070625		P-UB-10	1-7/8	3-1/4	CTC-3E3297	98.56
	1165354		P-UB-10	2-1/8	4	CTC-1305923	158.53
<b>MODEL 416C</b>							
<b>BACKHOE BOOM</b>							
	6E0274		P-UB-10	2-3/8	4-1/2	CTC-3E8877	177.68
	1AR1-UP; 1BR1-UP; 1KR1-UP; 1LR1-UP; 1WR1-8115; 1XR1-415,684-2183; 4ZN1-16043; 5YN1-15147						
	6E0274		P-UB-10	2-3/8	4-1/2	CTC-1945583	81.63
<b>BACKHOE BUCKET</b>							
	1268308		I-UB-10	2-1/2	3-1/2	CTC-3E3299	134.08
	1AR1-UP; 1BR1-UP; 1KR1-UP; 1LR1-UP; 1WR1-UP; 1XR1-2249; 4ZN1-UP; 5YN1-16589						
	1268308		I-UB-10	2-1/2	3-1/2	CTC-1864327	69.65
	1XR2250-UP; 5YN16590-UP						
	1668140		I-UB-10	2-3/4	3-3/4	CTC-1361990	173.89
<b>BACKHOE EXT BUCKET</b>							
	6E1964		I-UB-10	2-1/2	3-1/2	CTC-3E3299	134.08
	1AR1-UP; 1BR1-UP; 1KR1-UP; 1LR1-UP; 1WR1-UP; 1XR1-2249; 4ZN1-UP; 5YN1-16589						
	6E1964		I-UB-10	2-1/2	3-1/2	CTC-1864327	69.65
	1XR2250-UP; 5YN16590-UP						
	1668141		I-UB-10	2-3/4	3-3/4	CTC-1361990	173.89
<b>BACKHOE EXT STICK</b>							
	1AR1-UP; 1BR1-UP; 1KR1-UP; 1LR1-UP; 1WR1-8115; 1XR1-UP; 4ZN1-16043; 5YN1-16589						
	6E0404		P-UB-10	1-1/2	3	CTC-1856583	45.80
	1WR8116-UP; 1XR2184-UP; 4ZN16044-UP; 5YN16590-UP						
	1647174		P-UB-10	1-1/2	3	CTC-1856583	45.80
<b>BACKHOE STICK</b>							
	1097020		P-UB-10	2-1/2	4-1/2	CTC-1113300	136.57
	6E0404		P-UB-10	1-1/2	3	CTC-7X2737	108.60
	1AR1-UP; 1BR1-UP; 1KR1-UP; 1LR1-UP; 1WR1-UP; 1XR1-2183; 4ZN1-16043; 5YN1-15147						
	1097020		P-UB-10	2-1/2	4-1/2	CTC-1113300	136.57

**CATERPILLAR®**



## REPLACEMENT KITS FOR CATERPILLAR® EQUIPMENT

Backhoe Loaders							
APPLICATION	CYL #	Misc-Parts, Instructions, etc.	CODE	ROD	BORE	KIT #	List \$
<b>MODEL 416C</b>							
<b>BACKHOE STICK</b>							
1WR10495-UP; 1XR2258-UP; 4ZN16044-UP; 5YN16590-UP							
1843709			P-UB-10	2-1/2	4-1/2	CTC-1843709K	73.54
1WR8116-UP; 1XR2184-UP; 4ZN16044-UP; 5YN15148-UP							
1692967			P-UB-10	2-1/2	4-1/2	CTC-1864362	73.04
<b>BACKHOE SWING</b>							
1166857							
			P-UB-10	2	4	CTC-1113302	118.96
1AR1-UP; 1BR1-438; 1BR649-UP; 1KR1-UP; 1LR1-UP; 1WR1-UP; 1XR1-2183; 4ZN1-16043; 5YN1-15147							
1166861			I-UB-10	2	4	CTC-1857686	91.22
1WR8116-UP; 1XR2184-UP; 4ZN16044-UP; 5YN15360-UP							
1699529			P-UB-10	2	4	CTC-1113302	118.96
<b>COUPLER</b>							
1KR1-UP; 1LR1-UP; 1WR1-UP; 1XR1-UP							
9T8823			I-O-3	1	2	CTC-9T0418	82.99
1WR8116-UP							
1783713			I-U-10	1	2	CTC-1809872	117.91
<b>LOADER BUCKET MP</b>							
9T4006							
			P-UB-10	1-1/2	3	CTC-7X2737	108.60
1AR1-UP; 1BR1-UP; 1KR1-UP; 1LR1-UP; 1WR1-UP; 1XR1-UP; 4ZN16044-UP; 5YN1-15147; 5YN16590-UP							
1851839			P-UB-10	1-1/2	3	CTC-1856583	45.80
1AR1-UP; 1BR1-UP; 1KR1-UP; 1LR1-UP; 1WR1-UP; 1XR1-UP; 4ZN1-UP; 5YN1-UP							
9T4006			P-UB-10	1-1/2	3	CTC-1856583	45.80
1XR2250-UP							
9T4006			P-UB-10	1-1/2	3	CTC-7X2737	108.60
<b>LOADER LIFT</b>							
1AR1-UP; 1BR1-UP; 4ZN1-16043; 5YN1-15147							
6E0103			P-UB-10	1-7/8	3-1/4	CTC-1933088	87.60
9T0415			P-UB-10	1-7/8	3-1/4	CTC-1933088	87.60
1AR1-UP; 1BR1-UP; 4ZN1-UP; 5YN1-UP							
1070624			P-UB-10	1-7/8	3-1/4	CTC-1933088	87.60
1KR1-UP; 1WR1-UP							
1235087			P-UB-10	2	3-1/2	CTC-2281778	77.70
1LR1-UP; 1XR1-UP							
1110888			P-UB-10	2	3-1/2	CTC-1857674	115.51
1235089			P-UB-10	2	3-1/2	CTC-1857674	115.51
<b>LOADER TILT</b>							
6E0105							
			P-UB-10	1-7/8	3-1/4	CTC-3E3297	98.56
1AR1-UP; 1BR1-648; 4ZN1-16043; 5YN1-3799							
6E0105			P-UB-10	1-7/8	3-1/4	CTC-1933088	87.60
9T5370			P-UB-10	1-7/8	3-1/4	CTC-1933088	87.60
1AR1-UP; 1BR1-UP; 4ZN1-UP; 5YN1-UP							
1070625			P-UB-10	1-7/8	3-1/4	CTC-1933088	87.60
1KR1-UP; 1LR1-UP; 1WR1-UP; 1XR1-UP							
1235091			P-UB-10	2	3	CTC-1857667	84.68
1WR9975-UP; 1XR2250-UP							
1835158			P-UB-10	2	3	CTC-1857667	84.68
<b>STABILIZER</b>							
1AR1-UP; 1BR1-UP; 1KR1-UP; 1LR1-UP; 1WR1-UP; 1XR1-2183; 4ZN1-16043; 5YN1-15147							
1311846			P-UB-10	2-1/8	4	CTC-1935431	87.60
1311847			P-UB-10	2-1/8	4	CTC-1935431	87.60
1WR8116-9103; 1XR2184-2249; 4ZN16044-UP; 5YN15148-16589							
1521806			P-UB-10	2-1/8	4	CTC-1864404	99.60
1WR8116-UP; 1XR2184-2249; 4ZN16044-UP; 5YN15148-16589							
1521796			P-UB-10	2-1/8	4	CTC-1864404	99.60
1WR8442-UP; 1XR2184-UP; 4ZN16044-UP; 5YN15148-UP							
1731926			P-UB-10	2-1/8	4	CTC-1864404	99.60
1731927			P-UB-10	2-1/8	4	CTC-1864404	99.60

**CATERPILLAR®**



## REPLACEMENT KITS FOR CATERPILLAR® EQUIPMENT

Backhoe Loaders							
APPLICATION	CYL #	Misc-Parts, Instructions, etc.	CODE	ROD	BORE	KIT #	List \$
<b>MODEL 416C</b>							
STABILIZER LH							
	1311846		P-UB-10	2-1/8	4	CTC-1305923	158.53
	1521806		P-UB-10	2-1/8	4	CTC-1305923	158.53
STABILIZER RH							
	1311847		P-UB-10	2-1/8	4	CTC-1305923	158.53
	1521796		P-UB-10	2-1/8	4	CTC-1305923	158.53
STEERING							
	1156437		P-UB-10	1-3/4	2-1/2	CTC-1539054	144.29
UNSPECIFIED APPLICATION							
	1070624		P-UB-10	1-7/8	3-1/4	CTC-3E3297	98.56
	1070625		P-UB-10	1-7/8	3-1/4	CTC-3E3297	98.56
	1235087		P-UB-10	2	3-1/2	CTC-7X2783	102.97
	1235091		P-UB-10	2	3	CTC-7X2760	70.47
	9T8823		I-O-3	1	2	CTC-9T0418	82.99
<b>MODEL 416D</b>							
BACKHOE BOOM							
	BFP1-2532; BGJ1-UP; BKG1-537						
	6E0274		P-UB-10	2-3/8	4-1/2	CTC-6E0274K	81.63
	BFP1-5177						
	2063630		P-UB-10	2-3/8	4-3/4	CTC-2350973	153.76
	BFP1-UP; BGJ1-UP; BKG1-UP; B2D1-UP						
	2063628		P-UB-10	2-3/8	4-1/2	CTC-2063628K	63.73
	BFP2533-5177; BGJ1-UP; BKG1-734						
	1917753		P-UB-10	2-3/8	4-1/2	CTC-1917753K	82.09
BACKHOE BUCKET							
	BFP1-5177; BGJ1-522; BKG1-1523						
	1804849		I-UB-10	2-1/2	3-1/2	CTC-2235945	66.26
	BFP1-5177; BGJ1-522; BKG1-UP						
	1804239		I-UB-10	2-1/2	3-1/2	CTC-2235945	66.26
	BFP1-UP; BGJ1-UP; BKG1300-UP; B2D1-UP						
	2060514		I-UB-10	2-1/2	3-1/2	CTC-2235945	66.26
	2060518		I-UB-10	2-1/2	3-1/2	CTC-2235945	66.26
	BGJ1050-UP						
	1917839		I-UB-10	2-3/4	3-3/4	CTC-1917839K	80.61
BACKHOE EXT STICK							
	BFP1-5177; BGJ1-408; BKG1-UP; B2D1-UP						
	1647174		P-UB-10	1-1/2	3	CTC-1856583	45.80
	BFP5178-UP; BGJ409-UP						
	1917725		P-UB-10	1-1/2	3	CTC-1917725K	41.48
BACKHOE STICK							
	BFP1-5177; BGJ1-1049; BKG1-777						
	1843709		P-UB-10	2-1/2	4-1/2	CTC-1843709K	73.54
	BFP2533-5177; BGJ1-1049; BKG777-2499						
	2060503		P-UB-10	2-1/2	4-1/2	CTC-2297194	55.17
	BFP5178-UP; BGJ1-UP; BKG2500-UP; B2D1-UP						
	2359829		P-UB-10	2-1/2	4-1/2	CTC-2297194	55.17
LOADER BUCKET MP							
	BFP12900-UP						
	2265540		I-U-10	1-1/2	3	CTC-2309357	55.43
	BFP1-UP; BGJ1-UP; BKG1-UP; CXP940-UP; B2D1-UP						
	1851839		P-UB-10	1-1/2	3	CTC-1851839K	40.75
LOADER LIFT							
	BFP1-2491; BGJ1-UP						
	1070624		P-UB-10	1-7/8	3-1/4	CTC-1070624K	44.20
	BFP12900-UP; BGJ1050-1140						
	2300979		P-U-10	1-7/8	3-1/4	CTC-2332628	138.57

**CATERPILLAR®**



## REPLACEMENT KITS FOR CATERPILLAR® EQUIPMENT

<b>Backhoe Loaders</b>							
APPLICATION	CYL #	Misc-Parts, Instructions, etc.	CODE	ROD	BORE	KIT #	List \$
<b>MODEL 416D</b>							
<b>LOADER LIFT</b>							
BFP1-UP; CXP1-UP; BGJ1-1049; BGJ1141-UP; BKG1-UP; B2D1-UP							
2063549			P-UB-10	1-7/8	3-1/4	CTC-2094979	45.18
BFP2492-5177; BGJ1-522; BKG1-776; CXP1-939							
1917843			P-UB-10	1-7/8	3-1/4	CTC-2094979	45.18
<b>LOADER TILT</b>							
BFP1-2491; BGJ1-522							
1851851			P-UB-10	1-7/8	3-1/4	CTC-1851851K	44.30
BFP1-UP; CXP1-UP; BGJ1-UP; BKG1-UP; B2D1-UP							
2063553			P-UB-10	1-7/8	3-1/4	CTC-2094979	45.18
BFP2492-5177; BGJ1-522; BKG1-1299; CXP1-939							
1924128			P-UB-10	1-7/8	3-1/4	CTC-2094979	45.18
<b>STABILIZER</b>							
B2D267-UP							
2627050			P-UB-10	55 mm	100 mm	CTC-2332623	108.28
BFP13748-UP; BGJ1141-UP; B2D267-UP							
2283499			P-UB-10	55 mm	100 mm	CTC-2332623	108.28
BFP13793-UP; BGJ1141-UP; B2D267-UP							
2283500			P-UB-10	55 mm	100 mm	CTC-2332623	108.28
BFP1-5177; BGJ1-1049; BKG1-776							
1807484			P-UB-10	2-1/8	4	CTC-1807484K	100.01
1807485			P-UB-10	2-1/8	4	CTC-1807485K	100.01
BFP1-UP; BGJ1-1140; BKG1-UP; B2D1-266							
2060520			P-UB-10	2-1/8	4	CTC-2060520K	100.01
2060522			P-UB-10	2-1/8	4	CTC-2060522K	100.01
<b>STEERING</b>							
BFP1-12899; BGJ1-1049; BKG1-UP							
1674235			P-UB-10	1-3/4	2-3/4	CTC-2350351	145.01
1674235			P-UB-10	1-3/4	2-3/4	CTC-2350352	100.66
BFP1-9559; BGJ1-1049; CXP1-399							
1787190			I-U-10	36 mm	65 mm	CTC-1787189	220.50
<b>SWING</b>							
BFP1-2461; BGJ1-1049							
1699529			P-UB-10	2	4	CTC-1699529K	72.66
BFP13793-UP; BGJ1141-UP; B2D267-UP							
2283506			P-UB-10	50 mm	100 mm	CTC-2332622	62.22
BFP2492-UP; BGJ1-1140; BKG1-UP; B2D1-UP							
1918161			P-UB-10	2	4	CTC-1918161K	46.75
<b>THUMB</b>							
BFP12900-UP							
2754243			I-U-10	50 mm	70 mm	CTC-2764172	46.99
<b>MODEL 416E</b>							
<b>BACKHOE BOOM</b>							
BWC1-UP; CBD1-UP; SHA1-UP							
2107074			P-UB-10	2-1/4	4-1/2	CTC-2959891	63.44
BWC1-UP; SHA1-UP							
2469885			P-UB-10	2-1/4	4-1/2	CTC-2469885K	61.22
<b>BACKHOE BUCKET</b>							
BWC1-UP; CBD1-UP; SHA1-UP							
2107086			I-UB-10	2-3/8	85 mm	CTC-2107086K	70.10
BWC1-UP; SHA1-UP							
2107085			I-UB-10	2-3/8	85 mm	CTC-2107085K	59.46
CBD1-UP							
2107088			I-UB-10	2-1/2	3-1/2	CTC-2107088K	33.54
<b>BACKHOE EXT STICK</b>							
BWC1-UP; CBD1-UP; SHA1-UP							
2107098			P-UB-10	1-1/2	3	CTC-2107098K	38.29

**CATERPILLAR®**



## REPLACEMENT KITS FOR CATERPILLAR® EQUIPMENT

Backhoe Loaders							
APPLICATION	CYL #	Misc-Parts, Instructions, etc.	CODE	ROD	BORE	KIT #	List \$
<b>MODEL 416E</b>							
BACKHOE EXT STICK							
	BWC1-UP; SHA1-UP						
	2107097		P-UB-10	1-1/2	3	CTC-2107097K	40.66
BACKHOE STICK							
	BWC1-UP; CBD1-UP; SHA1-UP						
	2107078		P-UB-10	2-1/4	4-1/4	CTC-2107078K	56.23
	BWC1-UP; SHA1-UP						
	2107077		P-UB-10	2-1/4	4-1/4	CTC-2107077K	58.61
GRAPPLE							
	CBD1-UP; SHA1-UP						
	2754243		I-U-10	50 mm	70 mm	CTC-2764172	46.99
LOADER BUCKET MP							
	BWC1-UP; CBD1-UP; SHA1-UP						
	2265540		I-U-10	1-1/2	3	CTC-2309357	55.43
	CBD1-UP						
	1851839		P-UB-10	1-1/2	3	CTC-1851839K	40.75
LOADER LIFT							
	BWC1-UP; CBD1-UP; SHA1-UP						
	2283508		P-U-10	1-7/8	3-1/4	CTC-2332628	138.57
LOADER TILT							
	BWC1-UP; CBD1-UP; SHA1-UP						
	2063553		P-UB-10	1-7/8	3-1/4	CTC-2063553K	44.94
STABILIZER							
	BWC1-UP; CBD1-5744; SHA1-UP						
	2627049		P-UB-10	55 mm	100 mm	CTC-2332623	108.28
	2627050		P-UB-10	55 mm	100 mm	CTC-2332623	108.28
SWING							
	BWC1-UP; CBD1-5744; SHA1-UP						
	2781971		P-UB-10	50 mm	100 mm	CTC-2332622	62.22
<b>MODEL 420D</b>							
BACKHOE BOOM							
	1529148		P-UB-10	2-3/8	4-3/4	CTC-2350973	153.76
	BKC1-501; BLN1-1832; BMC1-610; FDP1-3137						
	1529148		P-UB-10	2-3/8	4-3/4	CTC-1529148K	99.98
	BKC1-501; BLN1833-4543; BMC1-610; FDP3138-7198						
	1917846		P-UB-10	2-3/8	4-3/4	CTC-1917846K	100.47
	BKC1-UP; BLN1833-UP; BMC1-UP; FDP7199-UP; MBH1-UP						
	2063630		P-UB-10	2-3/8	4-3/4	CTC-2350973	153.76
BACKHOE BUCKET							
	1668140		I-UB-10	2-3/4	3-3/4	CTC-2235944	79.23
	BKC1-501; BLN1-4543; BMC1-610; FDP1-7198						
	1668140		I-UB-10	2-3/4	3-3/4	CTC-1668140K	79.86
	BKC1-UP; BLN1-UP; BMC1-UP; FDP1-UP						
	1917839		I-UB-10	2-3/4	3-3/4	CTC-1917839K	80.61
	BKC1-UP; BLN1-UP; BMC1-UP; FDP1-UP; MBH1-UP						
	1917835		I-UB-10	2-3/4	3-3/4	CTC-1917835K	80.57
	BLN1-4543; FDP1-7198						
	1668141		I-UB-10	2-3/4	3-3/4	CTC-1668141K	79.86
BACKHOE EXT BUCKET							
	1668141		I-UB-10	2-3/4	3-3/4	CTC-2235944	79.23
BACKHOE EXT STICK							
	1647174		P-UB-10	1-1/2	3	CTC-2350354	34.36
	BKC1-401; BLN1-4543; BMC1-506; FDP1-7198						
	1647174		P-UB-10	1-1/2	3	CTC-1647174K	51.66
	BKC402-UP; BLN4544-UP; BMC507-UP; FDP7199-UP						
	1917725		P-UB-10	1-1/2	3	CTC-1917725K	41.48





## REPLACEMENT KITS FOR CATERPILLAR® EQUIPMENT

<b>Backhoe Loaders</b>							
APPLICATION	CYL #	Misc-Parts, Instructions, etc.	CODE	ROD	BORE	KIT #	List \$
<b>MODEL 420D</b>							
<b>BACKHOE STICK</b>							
1843709			P-UB-10	2-1/2	4-1/2	CTC-2435805	113.45
BKC1-501; BLN1-4543; BMC1-610; FDP1-7198							
1843709			P-UB-10	2-1/2	4-1/2	CTC-1843709K	73.54
BKC1-919; BLN1833-10299; BMC1-1059; FDP7199-18399							
2060503			P-UB-10	2-1/2	4-1/2	CTC-2060503K	55.17
BKC502-UP; BLN8014-UP; BMC1-UP; FDP10193-UP; MBH1-UP							
2359829			P-UB-10	2-1/2	4-1/2	CTC-2359829K	55.14
<b>BACKHOE SWING</b>							
1699529			P-UB-10	2	4	CTC-1113302	118.96
<b>COUPLER</b>							
BLN1-UP; MBH1-UP							
1783713			I-U-10	1	2	CTC-1809872	117.91
<b>GRAPPLE</b>							
BLN10300-UP; FDP18400-UP							
2754243			I-U-10	50 mm	70 mm	CTC-2764172	46.99
<b>LOADER BUCKET MP</b>							
1851839			P-UB-10	1-1/2	3	CTC-2350354	34.36
BKC1-UP; BLN1-UP; BMC1-UP; FDP1-UP; MBH1-UP							
1851839			P-UB-10	1-1/2	3	CTC-1851839K	40.75
FDP18400-UP; MBH1-UP							
2265540			I-U-10	1-1/2	3	CTC-2309357	55.43
<b>LOADER LIFT</b>							
1807490			P-UB-10	2	85 mm	CTC-2410110	123.40
1832856			P-UB-10	2	85 mm	CTC-2410110	123.40
BKC1-501; FDP1-7198							
1832856			P-UB-10	2	85 mm	CTC-1832856K	138.57
BKC1-UP; FDP7199-18399							
1964523			P-UB-10	2	85 mm	CTC-1964523K	138.52
BLN10300-UP; MBH1-UP							
2283505			P-U-10	50 mm	85 mm	CTC-2432276	83.04
BLN1-4543; BMC1-610							
1807490			P-UB-10	2	85 mm	CTC-1807490K	138.57
BLN1833-4543; BLN4544-10299; BMC1-UP							
1923791			P-UB-10	2	85 mm	CTC-1923791K	138.08
FDP18400-UP							
2300980			P-U-10	50 mm	85 mm	CTC-2432276	83.04
<b>LOADER TILT</b>							
1807482			P-UB-10	2	85 mm	CTC-2410110	123.40
1832848			P-UB-10	2	75 mm	CTC-2410109	91.25
BKC1-501; FDP1-7198							
1807482			P-UB-10	2	85 mm	CTC-1807482K	138.57
BKC1-501; FDP3138-7198							
1924110			P-UB-10	2	85 mm	CTC-1924110K	138.48
BKC1-919; FDP7450-UP							
2007128			P-UB-10	2	4	CTC-2007128K	46.79
BKC1-UP; FDP7199-7449							
2063555			P-UB-10	2	85 mm	CTC-2063555K	138.52
BLN1-4543; BMC1-610							
1832848			P-UB-10	2	75 mm	CTC-1832848K	92.61
BLN1833-UP; BMC1-UP; MBH1-UP							
1923884			P-UB-10	2	75 mm	CTC-1923884K	68.56
<b>STABILIZER</b>							
BKC1-501; BLN1-4543; BMC1-610; FDP1-7198							
1807484			P-UB-10	2-1/8	4	CTC-1807484K	100.01
1807485			P-UB-10	2-1/8	4	CTC-1807485K	100.01

**CATERPILLAR®**



## REPLACEMENT KITS FOR CATERPILLAR® EQUIPMENT

Backhoe Loaders							
APPLICATION	CYL #	Misc-Parts, Instructions, etc.	CODE	ROD	BORE	KIT #	List \$
<b>MODEL 420D</b>							
STABILIZER							
BKC1-920; BLN1833-11017; BMC1-1063; FDP7199-20367							
2060520			P-UB-10	2-1/8	4	CTC-2060520K	100.01
BKC1-920; BLN1833-11017; BMC1-1063; FDP7199-20477							
2060522			P-UB-10	2-1/8	4	CTC-2060522K	100.01
BKC921-UP; BLN11018-UP; BMC1064-UP; FDP20368-UP; MBH1-UP							
2283499			P-UB-10	55 mm	100 mm	CTC-2332623	108.28
BKC921-UP; BLN11018-UP; BMC1064-UP; FDP20478-UP; MBH1-UP							
2283500			P-UB-10	55 mm	100 mm	CTC-2332623	108.28
STEERING							
1674235	ENG 03-UP		P-UB-10	1-3/4	2-3/4	CTC-2350351	145.01
1674235	ENG 00-02		P-UB-10	1-3/4	2-3/4	CTC-2350352	100.66
SWING							
BKC1-501; BLN1-1832; BMC1-610; FDP1-3137							
1699529			P-UB-10	2	4	CTC-1699529K	72.66
BKC1-920; BLN1833-11084; BMC1-1063; FDP3138-20480							
1918161			P-UB-10	2	4	CTC-1918161K	46.75
BKC921-UP; BLN11085-UP; BMC1064-UP; FDP20481-UP; MBH1-UP							
2283506			P-UB-10	50 mm	100 mm	CTC-2332622	62.22
<b>MODEL 420E</b>							
BACKHOE BOOM							
GAN1-UP; HLS1-UP; KMW1-UP; PHC1-UP; PRA1-UP							
2107076			P-UB-10	2-3/8	4-3/4	CTC-2107076K	101.55
HLS1-UP; KMW1-UP; PHC1-UP; PRA1-UP							
2689049			P-UB-10	2-3/8	4-3/4	CTC-2689049K	103.89
BACKHOE BUCKET							
GAN1-UP; HLS1-UP; KMW1-UP; PHC1-UP; PRA1-UP							
2107088			I-UB-10	2-1/2	3-1/2	CTC-2107088K	33.54
HLS1-UP; KMW1-UP; PHC1-UP; PRA1-UP							
2107087			I-UB-10	2-1/2	3-1/2	CTC-2107087K	36.23
BACKHOE EXT STICK							
HLS1-UP; KMW1-UP; PHC1-UP; PRA1-UP							
2107097			P-UB-10	1-1/2	3	CTC-2107097K	40.66
2107098			P-UB-10	1-1/2	3	CTC-2107098K	38.29
BACKHOE STICK							
GAN1-UP; HLS1-UP; KMW1-UP; PHC1-UP; PRA1-UP							
2107082			P-UB-10	65 mm	4-3/4	CTC-2107082K	169.49
HLS1-UP; KMW1-UP; PHC1-UP; PRA1-UP							
2107081			P-UB-10	65 mm	4-3/4	CTC-2107081K	171.33
BACKHOE SWING							
GAN1-UP; HLS1-UP; KMW1-UP; PHC1-UP; PRA1-UP							
2781971			P-UB-10	50 mm	100 mm	CTC-2332622	62.22
COUPLER							
GAN1-UP; KMW1-UP; PHC1-UP							
1903085			I-U-10	1	2	CTC-1809872	117.91
GRAPPLE							
HLS1-UP; KMW1-UP							
2754243			I-U-10	50 mm	70 mm	CTC-2764172	46.99
LOADER BUCKET MP							
GAN1-UP; HLS1-UP; KMW1-UP; PHC1-UP; PRA1-UP							
2265540			I-U-10	1-1/2	3	CTC-2309357	55.43
LOADER LIFT							
GAN1-UP; KMW1-UP; PHC1-UP							
2283505			P-U-10	50 mm	85 mm	CTC-2432276	83.04
HLS1-UP; PRA1-UP							
2283509			P-U-10	50 mm	85 mm	CTC-2432276	83.04



## REPLACEMENT KITS FOR CATERPILLAR® EQUIPMENT

Backhoe Loaders							
APPLICATION	CYL #	Misc-Parts, Instructions, etc.	CODE	ROD	BORE	KIT #	List \$
<b>MODEL 420E</b>							
LOADER TILT							
GAN1-UP; KMW1-UP; PHC1-UP							
1923884			P-UB-10	2	75 mm	CTC-1923884K	68.56
HLS1-UP; PRA1-UP							
2007128			P-UB-10	2	4	CTC-2007128K	46.79
STABILIZER							
GAN1-UP; HLS1-UP; KMW1-UP; PHC1-UP; PRA1-UP							
2627049			P-UB-10	55 mm	100 mm	CTC-2332623	108.28
2627050			P-UB-10	55 mm	100 mm	CTC-2332623	108.28
<b>MODEL 426</b>							
BACKHOE BACKHOE BOOM							
4T6969			P-UB-10	2-1/8	3-1/2	CTC-8T3591	104.90
6E0109			P-UB-10	2	3-1/2	CTC-7X2783	102.97
BACKHOE BOOM							
9T5222			P-UB-10	2	3-1/2	CTC-7X2822	95.53
BACKHOE BUCKET							
4T5601			P-UB-10	2	3-1/4	CTC-7X2821	140.11
6E0091			I-UB-10	2-1/2	3-1/2	CTC-3E3299	134.08
9T0735			P-UB-10	2	3-1/2	CTC-7X2822	95.53
9T2751			P-UB-10	2	3-1/4	CTC-7X2821	140.11
9T7287			I-UB-10	2-1/2	3-1/2	CTC-3E3299	134.08
9T7894			P-UB-10	2	3-1/4	CTC-7X2821	140.11
BACKHOE EXT STICK							
9T2215			P-UB-10	1-1/2	3	CTC-7X2737	108.60
9T2215			P-UB-10	1-1/2	3	CTC-7X2745	108.60
9T4809			P-UB-10	1-1/2	3	CTC-7X2737	108.60
9T7893			P-UB-10	2	3-1/4	CTC-7X2821	140.11
BACKHOE STICK							
4T6968			P-UB-10	2-1/8	4	CTC-1305923	158.53
6E0111			P-UB-10	2-1/2	4-1/4	CTC-3E3300	107.47
9T2215			P-UB-10	1-1/2	3	CTC-7X2737	108.60
9T5220			P-UB-10	2-1/8	4	CTC-1305923	158.53
9T7066			P-UB-10	2-1/8	4	CTC-1305923	158.53
9T7289			P-UB-10	2-1/2	4-1/4	CTC-3E3300	107.47
BACKHOE SWING							
6E0093			P-UB-10	2-1/8	4	CTC-1305923	158.53
BACKHOE SWING LH							
4T6879			P-UB-10	2-1/8	4	CTC-1305923	158.53
BACKHOE SWING RH							
9T0529			P-UB-10	2-1/8	4	CTC-1305923	158.53
LOADER BUCKET MP							
9T4006			P-UB-10	1-1/2	3	CTC-7X2737	108.60
LOADER LIFT							
6E0103			P-UB-10	1-7/8	3-1/4	CTC-3E3297	98.56
9T0415			P-UB-10	1-7/8	3-1/4	CTC-3E3297	98.56
LOADER TILT							
6E0113			P-UB-10	2	3-1/2	CTC-7X2783	102.97
9T0735			P-UB-10	2	3-1/2	CTC-7X2822	95.53
9T5370			P-UB-10	1-7/8	3-1/4	CTC-8T3589	80.81
9T5371			P-UB-10	2	3-1/2	CTC-7X2783	102.97
9T5371			P-UB-10	2	3-1/2	CTC-7X2822	95.53
STABILIZER							
9T7391			P-UB-10	2-1/8	4	CTC-1305923	158.53
9T7392			P-UB-10	2-1/8	4	CTC-1305923	158.53

CATERPILLAR®



## REPLACEMENT KITS FOR CATERPILLAR® EQUIPMENT

Backhoe Loaders							
APPLICATION	CYL #	Misc-Parts, Instructions, etc.	CODE	ROD	BORE	KIT #	List \$
<b>MODEL 426</b>							
STABILIZER LH							
	4T9911		P-UB-10	2-1/8	4	CTC-1305923	158.53
	6E0097		P-UB-10	2-1/8	4	CTC-1305923	158.53
	9T7070		P-UB-10	2-1/8	4	CTC-1305923	158.53
STABILIZER RH							
	4T6880		P-UB-10	2-1/8	4	CTC-1305923	158.53
	6E0099		P-UB-10	2-1/8	4	CTC-1305923	158.53
	9T7069		P-UB-10	2-1/8	4	CTC-1305923	158.53
STEERING							
	6E5190		P-UB-10	1-7/8	3	CTC-1113301	131.00
	9T1493		P-UB-10	1-7/8	3	CTC-8T3852	192.90
UNSPECIFIED APPLICATION							
	1070624		P-UB-10	1-7/8	3-1/4	CTC-3E3297	98.56
<b>MODEL 426B</b>							
BACKHOE BACKHOE BOOM							
	6E1948		P-UB-10	2-1/2	5	CTC-1361967	193.76
BACKHOE BUCKET							
	1268316		I-UB-10	2-3/4	3-3/4	CTC-9X2020	108.84
	6E1809		I-UB-10	2-3/4	3-3/4	CTC-9X2020	108.84
BACKHOE EXT BUCKET							
	6E3692		I-UB-10	2-3/4	3-3/4	CTC-9X2020	108.84
BACKHOE STICK							
	6E1935		P-UB-10	2-3/4	5	CTC-3E8878	182.11
	6E3662		P-UB-10	1-1/2	3	CTC-7X2737	108.60
BACKHOE SWING							
	1166861		P-UB-10	2	4	CTC-1113302	118.96
	6E0288		P-UB-10	2	4	CTC-1113302	118.96
	6E1864		P-UB-10	2	4	CTC-1328816	92.75
LOADER BUCKET MP							
	9T4006		P-UB-10	1-1/2	3	CTC-7X2737	108.60
LOADER LIFT							
	6E0103		P-UB-10	1-7/8	3-1/4	CTC-3E3297	98.56
	9T0415		P-UB-10	1-7/8	3-1/4	CTC-3E3297	98.56
LOADER TILT							
	1071855		P-UB-10	2	3-1/2	CTC-7X2783	102.97
	6E0113		P-UB-10	2	3-1/2	CTC-7X2783	102.97
STABILIZER							
	1052323		P-UB-10	2-1/8	4	CTC-1305923	158.53
	1052358		P-UB-10	2-1/8	4	CTC-1305923	158.53
STABILIZER LH							
	1165354		P-UB-10	2-1/8	4	CTC-1305923	158.53
	1302364		P-UB-10	2-1/8	4	CTC-1305923	158.53
	6E0098		P-UB-10	2-1/8	4	CTC-1305923	158.53
STABILIZER RH							
	1165353		P-UB-10	2-1/8	4	CTC-1305923	158.53
	1302365		P-UB-10	2-1/8	4	CTC-1305923	158.53
	6E0099		P-UB-10	2-1/8	4	CTC-1305923	158.53
STEERING							
	6E5190		P-UB-10	1-7/8	3	CTC-1113301	131.00
UNSPECIFIED APPLICATION							
	1070624		P-UB-10	1-7/8	3-1/4	CTC-3E3297	98.56
<b>MODEL 426C</b>							
BACKHOE BOOM							
	6E1948		P-UB-10	2-1/2	5	CTC-1361967	193.76
BACKHOE BUCKET							
	1268316		I-UB-10	2-3/4	3-3/4	CTC-9X2020	108.84

CATERPILLAR®



## REPLACEMENT KITS FOR CATERPILLAR® EQUIPMENT

<b>Backhoe Loaders</b>							
APPLICATION	CYL #	Misc-Parts, Instructions, etc.	CODE	ROD	BORE	KIT #	List \$
<b>MODEL 426C</b>							
<b>BACKHOE EXT BUCKET</b>							
	6E3692		I-UB-10	2-3/4	3-3/4	CTC-9X2020	108.84
<b>BACKHOE STICK</b>							
	1535735		P-UB-10	1-1/2	3	CTC-7X2737	108.60
	6E1935		P-UB-10	2-3/4	5	CTC-3E8878	182.11
	6E3662		P-UB-10	1-1/2	3	CTC-7X2737	108.60
<b>BACKHOE SWING</b>							
	1166861		P-UB-10	2	4	CTC-1113302	118.96
<b>LOADER BUCKET MP</b>							
	9T4006		P-UB-10	1-1/2	3	CTC-7X2737	108.60
<b>LOADER LIFT</b>							
	1108688		P-UB-10	2	3-1/2	CTC-7X2783	102.97
	1216764		P-UB-10	2	3-1/2	CTC-7X2783	102.97
<b>LOADER TILT</b>							
	1071855		P-UB-10	2	3-1/2	CTC-7X2783	102.97
<b>STABILIZER LH</b>							
	1311846		P-UB-10	2-1/8	4	CTC-1305923	158.53
	1521806		P-UB-10	2-1/8	4	CTC-1305923	158.53
<b>STABILIZER RH</b>							
	1311847		P-UB-10	2-1/8	4	CTC-1305923	158.53
	1521796		P-UB-10	2-1/8	4	CTC-1305923	158.53
<b>STEERING</b>							
	1156437		P-UB-10	1-3/4	2-1/2	CTC-1539054	144.29
<b>UNSPECIFIED APPLICATION</b>							
	1235087		P-UB-10	2	3-1/2	CTC-7X2783	102.97
	1235091		P-UB-10	2	3	CTC-7X2760	70.47
	9T8823		I-O-3	1	2	CTC-9T0418	82.99
<b>MODEL 428</b>							
<b>BACKHOE BOOM</b>							
	4T6878		P-UB-10	1-7/8	3-1/4	CTC-8T3589	80.81
	4T6969		P-UB-10	2-1/8	3-1/2	CTC-8T3591	104.90
	6E0087		P-UB-10	1-7/8	3-1/4	CTC-3E3297	98.56
	9T5219		P-UB-10	1-7/8	3-1/4	CTC-3E3297	98.56
	9T5219		P-UB-10	1-7/8	3-1/4	CTC-8T3589	80.81
<b>BACKHOE BUCKET</b>							
	4T5601		P-UB-10	2	3-1/4	CTC-7X2821	140.11
	6E0091		I-UB-10	2-1/2	3-1/2	CTC-3E3299	134.08
	9T2751		P-UB-10	2	3-1/4	CTC-7X2821	140.11
	9T7287		I-UB-10	2-1/2	3-1/2	CTC-3E3299	134.08
	9T7893		P-UB-10	2	3-1/4	CTC-7X2821	140.11
	9T7894		P-UB-10	2	3-1/4	CTC-7X2821	140.11
<b>BACKHOE EXT STICK</b>							
	9T2215		P-UB-10	1-1/2	3	CTC-7X2745	108.60
	9T4809		P-UB-10	1-1/2	3	CTC-7X2737	108.60
	9T7893		P-UB-10	2	3-1/4	CTC-7X2821	140.11
<b>BACKHOE STICK</b>							
	4T6877		P-UB-10	2-1/8	4	CTC-8T3593	70.99
	4T6893		P-UB-10	2-1/8	4	CTC-1305923	158.53
	6E0089		P-UB-10	2-1/2	4-1/4	CTC-3E3300	107.47
	9T2214		P-UB-10	1-1/2	3	CTC-7X2737	108.60
	9T2762		P-UB-10	2-1/8	4	CTC-8T3593	70.99
	9T5215		P-UB-10	2-1/8	4	CTC-1305923	158.53
	9T5216		P-UB-10	2-1/8	4	CTC-8T3593	70.99
	9T7063		P-UB-10	2-1/8	4	CTC-1305923	158.53
	9T7291		P-UB-10	2-1/2	4-1/4	CTC-3E3300	107.47

**CATERPILLAR®**



## REPLACEMENT KITS FOR CATERPILLAR® EQUIPMENT

<b>Backhoe Loaders</b>							
APPLICATION	CYL #	Misc-Parts, Instructions, etc.	CODE	ROD	BORE	KIT #	List \$
<b>MODEL 428</b>							
<b>BACKHOE SWING</b>							
	9T0420		P-UB-10	2-1/8	4	CTC-8T3593	70.99
	9T0421		P-UB-10	2-1/8	4	CTC-8T3593	70.99
<b>BACKHOE SWING LH</b>							
	9T0421		P-UB-10	2-1/8	4	CTC-1305923	158.53
<b>BACKHOE SWING RH</b>							
	9T0420		P-UB-10	2-1/8	4	CTC-1305923	158.53
<b>LOADER BUCKET MP</b>							
	9T4006		P-UB-10	1-1/2	3	CTC-7X2737	108.60
<b>LOADER LIFT</b>							
	6E0103		P-UB-10	1-7/8	3-1/4	CTC-3E3297	98.56
	9T0415		P-UB-10	1-7/8	3-1/4	CTC-3E3297	98.56
<b>LOADER TILT</b>							
	6E0113		P-UB-10	2	3-1/2	CTC-7X2783	102.97
	9T0735		P-UB-10	2	3-1/2	CTC-7X2822	95.53
	9T0770		P-UB-10	2	3-1/2	CTC-7X2783	102.97
	9T5370		P-UB-10	1-7/8	3-1/4	CTC-8T3589	80.81
	9T5371		P-UB-10	2	3-1/2	CTC-7X2783	102.97
	9T5371		P-UB-10	2	3-1/2	CTC-7X2822	95.53
<b>STABILIZER</b>							
	6E0119		P-UB-10	1-3/4	2-3/4	CTC-1539053	150.78
	9T0527		P-UB-10	1-3/4	2-3/4	CTC-7X2820	79.12
	9T9709		P-UB-10	1-3/4	2-3/4	CTC-7X2820	79.12
<b>STEERING</b>							
	9T1493		P-UB-10	1-7/8	3	CTC-8T3852	192.90
<b>UNSPECIFIED APPLICATION</b>							
	1070624		P-UB-10	1-7/8	3-1/4	CTC-3E3297	98.56
<b>MODEL 428B</b>							
<b>BACKHOE BOOM</b>							
	6E0274		P-UB-10	2-3/8	4-1/2	CTC-3E8877	177.68
<b>BACKHOE BUCKET</b>							
	1268308		I-UB-10	2-1/2	3-1/2	CTC-3E3299	134.08
	6E0275		I-UB-10	2-1/2	3-1/2	CTC-3E3299	134.08
<b>BACKHOE EXT BUCKET</b>							
	6E1964		I-UB-10	2-1/2	3-1/2	CTC-3E3299	134.08
	6E2421		I-UB-10	2-3/4	3-3/4	CTC-9X2020	108.84
<b>BACKHOE STICK</b>							
	1097021		P-UB-10	2-1/2	4-1/2	CTC-1113300	136.57
	6E0290	Rod Bearing width- 0.98"	P-UB-10	2-1/2	4-1/2	CTC-1113300	136.57
	6E0290	Rod Bearing width- 1.25"	P-UB-10	2-1/2	4-1/2	CTC-1469860	161.26
	6E0404		P-UB-10	1-1/2	3	CTC-7X2737	108.60
<b>BACKHOE SWING</b>							
	1166861		P-UB-10	2	4	CTC-1113302	118.96
	6E0288		P-UB-10	2	4	CTC-1113302	118.96
<b>BACKHOE SWING LH</b>							
	1166858		P-UB-10	2	4	CTC-1113302	118.96
	6E1864		P-UB-10	2	4	CTC-1113302	118.96
<b>LOADER BUCKET MP</b>							
	9T4006		P-UB-10	1-1/2	3	CTC-7X2737	108.60
<b>LOADER LIFT</b>							
	6E0103		P-UB-10	1-7/8	3-1/4	CTC-3E3297	98.56
	9T0415		P-UB-10	1-7/8	3-1/4	CTC-3E3297	98.56
<b>LOADER TILT</b>							
	1071855		P-UB-10	2	3-1/2	CTC-7X2783	102.97
	6E0113		P-UB-10	2	3-1/2	CTC-7X2783	102.97
<b>SIDESHIFT</b>							
	1166858		P-UB-10	2	4	CTC-1113302	118.96





## REPLACEMENT KITS FOR CATERPILLAR® EQUIPMENT

<b>Backhoe Loaders</b>							
APPLICATION	CYL #	Misc-Parts, Instructions, etc.	CODE	ROD	BORE	KIT #	List \$
<b>MODEL 428B</b>							
<b>SIDESHIFT RH</b>							
	1166858		P-UB-10	2	4	CTC-1113302	118.96
<b>STABILIZER</b>							
	1266950		P-UB-10	1-3/4	2-3/4	CTC-1539053	150.78
	6E3483		P-UB-10	1-3/4	2-3/4	CTC-1539053	150.78
<b>STEERING</b>							
	6E5190		P-UB-10	1-7/8	3	CTC-1113301	131.00
<b>UNSPECIFIED APPLICATION</b>							
	1070624		P-UB-10	1-7/8	3-1/4	CTC-3E3297	98.56
<b>MODEL 428C</b>							
<b>BACKHOE BOOM</b>							
	6E0274		P-UB-10	2-3/8	4-1/2	CTC-3E8877	177.68
<b>BACKHOE BUCKET</b>							
	1268308		I-UB-10	2-1/2	3-1/2	CTC-3E3299	134.08
	1268312		I-UB-10	2-3/4	3-3/4	CTC-1361990	173.89
	6E0275		I-UB-10	2-1/2	3-1/2	CTC-3E3299	134.08
<b>BACKHOE EXT BUCKET</b>							
	6E1964		I-UB-10	2-1/2	3-1/2	CTC-3E3299	134.08
<b>BACKHOE STICK</b>							
	1097021		P-UB-10	2-1/2	4-1/2	CTC-1113300	136.57
	6E0404		P-UB-10	1-1/2	3	CTC-7X2737	108.60
<b>BACKHOE SWING</b>							
	1166861		P-UB-10	2	4	CTC-1113302	118.96
<b>LOADER BUCKET MP</b>							
	9T4006		P-UB-10	1-1/2	3	CTC-7X2737	108.60
<b>LOADER TILT</b>							
	1071855		P-UB-10	2	3-1/2	CTC-7X2783	102.97
<b>SIDESHIFT</b>							
	1166858		P-UB-10	2	4	CTC-1113302	118.96
<b>SIDESHIFT RH</b>							
	1166858		P-UB-10	2	4	CTC-1113302	118.96
<b>STABILIZER</b>							
	1266950		P-UB-10	1-3/4	2-3/4	CTC-1539053	150.78
<b>STEERING</b>							
	1156437		P-UB-10	1-3/4	2-1/2	CTC-1539054	144.29
<b>UNSPECIFIED APPLICATION</b>							
	1070624		P-UB-10	1-7/8	3-1/4	CTC-3E3297	98.56
	1235087		P-UB-10	2	3-1/2	CTC-7X2783	102.97
	1235091		P-UB-10	2	3	CTC-7X2760	70.47
	9T8823		I-O-3	1	2	CTC-9T0418	82.99
<b>MODEL 430D</b>							
<b>BACKHOE BOOM</b>							
BML1-2280; BNK1-2501							
	1832849		P-UB-10	2-3/4	5-3/8	CTC-1832849K	143.49
BML1-UP; BNK2502-UP							
	2058655		P-UB-10	2-3/4	5-3/8	CTC-2058655K	143.54
<b>BACKHOE BUCKET</b>							
BML1-2280; BNK1-2501							
	1668140		I-UB-10	2-3/4	3-3/4	CTC-1668140K	79.86
	1668141		I-UB-10	2-3/4	3-3/4	CTC-1668141K	79.86
BML1-UP; BNK1-UP							
	1917835		I-UB-10	2-3/4	3-3/4	CTC-2315021	80.61
	1917839		I-UB-10	2-3/4	3-3/4	CTC-2315021	80.61
<b>BACKHOE EXT STICK</b>							
BML1-2280; BNK1-2501							
	1535735		P-UB-10	1-1/2	3	CTC-2350354	34.36

**CATERPILLAR®**



## REPLACEMENT KITS FOR CATERPILLAR® EQUIPMENT

Backhoe Loaders							
APPLICATION	CYL #	Misc-Parts, Instructions, etc.	CODE	ROD	BORE	KIT #	List \$
<b>MODEL 430D</b>							
<b>BACKHOE EXT STICK</b>							
BML2281-UP; BNK2502-UP							
1917721			P-UB-10	1-1/2	3	CTC-1917721K	41.48
<b>BACKHOE STICK</b>							
BML1-1116; BNK1-2051							
1832850			P-UB-10	65 mm	4-3/4	CTC-1832850K	159.19
BML1-UP; BNK2502-UP							
2058656			P-UB-10	65 mm	4-3/4	CTC-2058656K	140.07
<b>BACKHOE SWING</b>							
BML1-1116; BNK1-1032							
1699529			P-UB-10	2	4	CTC-1699529K	72.66
BML1-5023; BNK1033-6261							
1918161			P-UB-10	2	4	CTC-1918161K	46.75
BML5013-UP; BNK6262-UP							
2283506			P-UB-10	50 mm	100 mm	CTC-2332622	62.22
<b>COUPLER</b>							
BML1-UP							
1783713			I-U-10	1	2	CTC-1809872	117.91
<b>GRAPPLE</b>							
BML4800-UP; BNK5900-UP							
2754243			I-U-10	50 mm	70 mm	CTC-2764172	46.99
<b>LOADER BUCKET MP</b>							
BML1-UP; BNK1-UP							
1851839			P-UB-10	1-1/2	3	CTC-1851839K	40.75
BML4800-UP; BNK5900-UP							
2265540			I-U-10	1-1/2	3	CTC-2309357	55.43
<b>LOADER LIFT</b>							
BML1-2280							
1807490			P-UB-10	2	85 mm	CTC-1807490K	138.57
BML1-4799							
1923791			P-UB-10	2	85 mm	CTC-1923791K	138.08
BML4800-UP							
2283505			P-U-10	50 mm	85 mm	CTC-2432276	83.04
BNK1-2501							
1832856			P-UB-10	2	85 mm	CTC-1832856K	138.57
BNK2502-5899							
1964523			P-UB-10	2	85 mm	CTC-1964523K	138.52
BNK5900-UP							
2300980			P-U-10	50 mm	85 mm	CTC-2432276	83.04
<b>LOADER TILT</b>							
BML1-2280							
1832848			P-UB-10	2	75 mm	CTC-1832848K	92.61
BML1-UP							
1923884			P-UB-10	2	75 mm	CTC-1923884K	68.56
BNK1033-2501							
1924110			P-UB-10	2	85 mm	CTC-1924110K	138.48
BNK1-1032							
1807482			P-UB-10	2	85 mm	CTC-1807482K	138.57
BNK2502-2558							
2063555			P-UB-10	2	85 mm	CTC-2063555K	138.52
BNK2502-UP							
2007128			P-UB-10	2	4	CTC-2007128K	46.79
<b>STABILIZER</b>							
BML1-2280; BNK1-2501							
1807484			P-UB-10	2-1/8	4	CTC-1807484K	100.01
1807485			P-UB-10	2-1/8	4	CTC-1807485K	100.01

CATERPILLAR®



## REPLACEMENT KITS FOR CATERPILLAR® EQUIPMENT

<b>Backhoe Loaders</b>							
APPLICATION	CYL #	Misc-Parts, Instructions, etc.	CODE	ROD	BORE	KIT #	List \$
<b>MODEL 430D</b>							
<b>STABILIZER</b>							
BML1-5012; BNK2502-6244							
2060520			P-UB-10	2-1/8	4	CTC-2060520K	100.01
BML1-5012; BNK2502-6261							
2060522			P-UB-10	2-1/8	4	CTC-2060522K	100.01
BML5013-UP; BNK6245-UP							
2283499			P-UB-10	55 mm	100 mm	CTC-2332623	108.28
BML5013-UP; BNK6262-UP							
2283500			P-UB-10	55 mm	100 mm	CTC-2332623	108.28
<b>MODEL 430E</b>							
<b>BACKHOE BOOM</b>							
DDT1-UP; EAT1-UP; RLN1-UP; SCD1-UP							
2469884			P-UB-10	3	5-1/4	CTC-2959887	117.14
2689051			P-UB-10	3	5-1/4	CTC-2689051K	114.56
<b>BACKHOE BUCKET</b>							
DDT1-UP; EAT1-UP; RLN1-UP; SCD1-UP							
1668140			I-UB-10	2-3/4	3-3/4	CTC-1668140K	79.86
2107096			I-UB-10	2-3/4	3-3/4	CTC-2107096K	84.29
<b>BACKHOE EXT STICK</b>							
DDT1-UP; EAT1-UP; RLN1-UP; SCD1-UP							
2107092			P-UB-10	2-1/2	5	CTC-2107092K	72.78
2107097			P-UB-10	1-1/2	3	CTC-2107097K	40.66
2107098			P-UB-10	1-1/2	3	CTC-2107098K	38.29
<b>BACKHOE STICK</b>							
DDT1-UP; EAT1-UP; RLN1-UP; SCD1-UP							
2107091			P-UB-10	2-1/2	5	CTC-2107091K	75.43
<b>COUPLER</b>							
DDT1-UP; SCD1-UP							
1903085			I-U-10	1	2	CTC-1809872	117.91
<b>GRAPPLE</b>							
DDT1-UP; EAT1-UP							
2754243			I-U-10	50 mm	70 mm	CTC-2764172	46.99
<b>LOADER BUCKET MP</b>							
DDT1-UP; EAT1-UP; RLN1-UP; SCD1-UP							
2265540			I-U-10	1-1/2	3	CTC-2309357	55.43
<b>LOADER LIFT</b>							
DDT1-UP; SCD1-UP							
2283505			P-U-10	50 mm	85 mm	CTC-2432276	83.04
EAT1-UP; RLN1-UP							
2283509			P-U-10	50 mm	85 mm	CTC-2432276	83.04
<b>LOADER TILT</b>							
DDT1-UP; SCD1-UP							
1923884			P-UB-10	2	75 mm	CTC-1923884K	68.56
EAT1-UP; RLN1-UP							
2007128			P-UB-10	2	4	CTC-2007128K	46.79
<b>STABILIZER</b>							
DDT1-UP; EAT1-UP; RLN1-UP; SCD1-UP							
2627049			P-UB-10	55 mm	100 mm	CTC-2332623	108.28
2627050			P-UB-10	55 mm	100 mm	CTC-2332623	108.28
<b>SWING</b>							
DDT1-UP; EAT1-UP; RLN1-UP; SCD1-UP							
2781971			P-UB-10	50 mm	100 mm	CTC-2332622	62.22
<b>MODEL 436</b>							
<b>BACKHOE BOOM</b>							
6E0109			P-UB-10	2	3-1/2	CTC-7X2783	102.97
9T5222			P-UB-10	2	3-1/2	CTC-7X2783	102.97
9T5222			P-UB-10	2	3-1/2	CTC-7X2822	95.53

**CATERPILLAR®**



## REPLACEMENT KITS FOR CATERPILLAR® EQUIPMENT

<b>Backhoe Loaders</b>							
APPLICATION	CYL #	Misc-Parts, Instructions, etc.	CODE	ROD	BORE	KIT #	List \$
<b>MODEL 436</b>							
<b>BACKHOE EXT STICK</b>							
	9T4809		P-UB-10	1-1/2	3	CTC-7X2737	108.60
<b>BACKHOE SWING</b>							
	4T6879		P-UB-10	2-1/8	4	CTC-1305923	158.53
	6E0093		P-UB-10	2-1/8	4	CTC-1305923	158.53
<b>BACKHOE SWING LH</b>							
	4T6879		P-UB-10	2-1/8	4	CTC-8T3593	70.99
<b>BACKHOE SWING RH</b>							
	9T0529		P-UB-10	2-1/8	4	CTC-1305923	158.53
<b>LOADER BUCKET MP</b>							
	9T4006		P-UB-10	1-1/2	3	CTC-7X2737	108.60
<b>LOADER LIFT</b>							
	6E0103		P-UB-10	1-7/8	3-1/4	CTC-3E3297	98.56
	9T0415		P-UB-10	1-7/8	3-1/4	CTC-3E3297	98.56
<b>LOADER TILT</b>							
	6E0113		P-UB-10	2	3-1/2	CTC-7X2783	102.97
	9T5371		P-UB-10	2	3-1/2	CTC-7X2783	102.97
	9T5371		P-UB-10	2	3-1/2	CTC-7X2822	95.53
<b>STABILIZER</b>							
	9T7391		P-UB-10	2-1/8	4	CTC-1305923	158.53
	9T7392		P-UB-10	2-1/8	4	CTC-1305923	158.53
<b>STABILIZER LH</b>							
	6E0097		P-UB-10	2-1/8	4	CTC-1305923	158.53
	9T7070		P-UB-10	2-1/8	4	CTC-1305923	158.53
<b>STABILIZER RH</b>							
	6E0099		P-UB-10	2-1/8	4	CTC-1305923	158.53
	9T7069		P-UB-10	2-1/8	4	CTC-1305923	158.53
<b>STEERING</b>							
	6E5190		P-UB-10	1-7/8	3	CTC-1113301	131.00
	9T1493		P-UB-10	1-7/8	3	CTC-8T3852	192.90
<b>UNSPECIFIED APPLICATION</b>							
	1070624		P-UB-10	1-7/8	3-1/4	CTC-3E3297	98.56
<b>MODEL 436B</b>							
<b>BACKHOE BOOM</b>							
	6E0274		P-UB-10	2-3/8	4-1/2	CTC-3E8877	177.68
	6E1948		P-UB-10	2-1/2	5	CTC-1361967	193.76
<b>BACKHOE BUCKET</b>							
	1268316		I-UB-10	2-3/4	3-3/4	CTC-9X2020	108.84
	6E0275		I-UB-10	2-1/2	3-1/2	CTC-3E3299	134.08
	6E1809		I-UB-10	2-3/4	3-3/4	CTC-9X2020	108.84
<b>BACKHOE EXT BUCKET</b>							
	6E3692		I-UB-10	2-3/4	3-3/4	CTC-9X2020	108.84
<b>BACKHOE STICK</b>							
	6E1935		P-UB-10	2-3/4	5	CTC-3E8878	182.11
	6E3662		P-UB-10	1-1/2	3	CTC-7X2737	108.60
<b>BACKHOE SWING</b>							
	1166861		P-UB-10	2	4	CTC-1113302	118.96
	6E0288		P-UB-10	2	4	CTC-1113302	118.96
	6E1864		P-UB-10	2	4	CTC-1328816	92.75
<b>LOADER BUCKET MP</b>							
	9T4006		P-UB-10	1-1/2	3	CTC-7X2737	108.60
<b>LOADER LIFT</b>							
	6E0103		P-UB-10	1-7/8	3-1/4	CTC-3E3297	98.56
	9T0415		P-UB-10	1-7/8	3-1/4	CTC-3E3297	98.56
<b>LOADER TILT</b>							
	1071855		P-UB-10	2	3-1/2	CTC-7X2783	102.97
	6E0113		P-UB-10	2	3-1/2	CTC-7X2783	102.97

**CATERPILLAR®**



## REPLACEMENT KITS FOR CATERPILLAR® EQUIPMENT

<b>Backhoe Loaders</b>							
APPLICATION	CYL #	Misc-Parts, Instructions, etc.	CODE	ROD	BORE	KIT #	List \$
<b>MODEL 436B</b>							
<b>STABILIZER</b>							
	1052323		P-UB-10	2-1/8	4	CTC-1305923	158.53
	1052358		P-UB-10	2-1/8	4	CTC-1305923	158.53
	9T2993		P-UB-10	2-1/8	4	CTC-9X2400	119.16
	9T2994		P-UB-10	2-1/8	4	CTC-9X2400	119.16
<b>STABILIZER LH</b>							
	1165354		P-UB-10	2-1/8	4	CTC-1305923	158.53
	1302364		P-UB-10	2-1/8	4	CTC-1305923	158.53
	6E0097		P-UB-10	2-1/8	4	CTC-1305923	158.53
<b>STABILIZER RH</b>							
	1165353		P-UB-10	2-1/8	4	CTC-1305923	158.53
	1302365		P-UB-10	2-1/8	4	CTC-1305923	158.53
	6E0099		P-UB-10	2-1/8	4	CTC-1305923	158.53
	9T7069		P-UB-10	2-1/8	4	CTC-8T3593	70.99
<b>STEERING</b>							
	6E5190		P-UB-10	1-7/8	3	CTC-1113301	131.00
<b>UNSPECIFIED APPLICATION</b>							
	1070624		P-UB-10	1-7/8	3-1/4	CTC-3E3297	98.56
<b>MODEL 436C</b>							
<b>BACKHOE BOOM</b>							
	1118211		P-UB-10	2-5/8	5-1/4	CTC-1361908	176.83
	6E1948		P-UB-10	2-1/2	5	CTC-1361967	193.76
<b>BACKHOE BUCKET</b>							
	1118216		I-UB-10	2-3/4	3-3/4	CTC-9X2020	108.84
	1268316		I-UB-10	2-3/4	3-3/4	CTC-9X2020	108.84
	9T6305		I-UB-10	2-3/4	3-3/4	CTC-9X2020	108.84
<b>BACKHOE EXT BUCKET</b>							
	1144828		I-UB-10	2-3/4	3-3/4	CTC-9X2020	108.84
	6E3692		I-UB-10	2-3/4	3-3/4	CTC-9X2020	108.84
	9T4760		I-UB-10	2-3/4	3-3/4	CTC-9X2020	108.84
<b>BACKHOE EXT STICK</b>							
	6E5383		P-UB-10	1-3/4	3	CTC-7X2825	53.69
<b>BACKHOE STICK</b>							
	1118213		P-UB-10	3	5-1/4	CTC-3E3293	177.73
	1239707		P-UB-10	1-3/4	3	CTC-7X2825	53.69
	1535735		P-UB-10	1-1/2	3	CTC-7X2737	108.60
	6E1936		P-UB-10	2-3/4	5	CTC-3E8878	182.11
	6E3062		P-UB-10	3	5-1/4	CTC-3E3293	177.73
	6E3314		P-UB-10	3	5-1/4	CTC-3E3293	177.73
	6E3662		P-UB-10	1-1/2	3	CTC-7X2737	108.60
	9T8823		I-O-3	1	2	CTC-9T0418	82.99
	9T9186		P-UB-10	3	5-1/4	CTC-3E3293	177.73
<b>BACKHOE SWING</b>							
	1121765		P-UB-10	2	4	CTC-1113302	118.96
	1166861		P-UB-10	2	4	CTC-1113302	118.96
	6E5219		P-UB-10	2	4	CTC-1113302	118.96
<b>BACKHOE SWING LH</b>							
	9T1701		P-UB-10	2-1/8	4	CTC-9X2400	119.16
<b>BACKHOE SWING RH</b>							
	9T1230		P-UB-10	2-1/8	4	CTC-9X2400	119.16
<b>LOADER BUCKET MP</b>							
	9T4006		P-UB-10	1-1/2	3	CTC-7X2737	108.60

**CATERPILLAR®**



## REPLACEMENT KITS FOR CATERPILLAR® EQUIPMENT

<b>Backhoe Loaders</b>							
APPLICATION	CYL #	Misc-Parts, Instructions, etc.	CODE	ROD	BORE	KIT #	List \$
<b>MODEL 436C</b>							
<b>LOADER LIFT</b>							
	1108688		P-UB-10	2	3-1/2	CTC-7X2783	102.97
	1117712		P-UB-10	2-1/4	3-3/4	CTC-1361897	159.18
	1216764		P-UB-10	2	3-1/2	CTC-7X2783	102.97
	1257895		P-UB-10	2-1/4	3-3/4	CTC-1361897	159.18
	9T2997		P-UB-10	2	3-3/4	CTC-7X7938	104.60
<b>LOADER TILT</b>							
	1007844		P-UB-10	2	4	CTC-1328816	92.75
	1071855		P-UB-10	2	3-1/2	CTC-7X2783	102.97
	9T2995		P-UB-10	2	4	CTC-1328816	92.75
<b>STABILIZER LH</b>							
	1311846		P-UB-10	2-1/8	4	CTC-1305923	158.53
	1329701		P-UB-10	2-1/8	4	CTC-1305923	158.53
	1521806		P-UB-10	2-1/8	4	CTC-1305923	158.53
	9T2994		P-UB-10	2-1/8	4	CTC-1305923	158.53
<b>STABILIZER RH</b>							
	1311847		P-UB-10	2-1/8	4	CTC-1305923	158.53
	1329700		P-UB-10	2-1/8	4	CTC-1305923	158.53
	1521796		P-UB-10	2-1/8	4	CTC-1305923	158.53
	9T2993		P-UB-10	2-1/8	4	CTC-1305923	158.53
<b>STEERING</b>							
	1156437		P-UB-10	1-3/4	2-1/2	CTC-1539054	144.29
<b>UNSPECIFIED APPLICATION</b>							
	1235087		P-UB-10	2	3-1/2	CTC-7X2783	102.97
	1235091		P-UB-10	2	3	CTC-7X2760	70.47
<b>MODEL 438</b>							
<b>BACKHOE BOOM</b>							
	6E0087		P-UB-10	1-7/8	3-1/4	CTC-3E3297	98.56
	9T5219		P-UB-10	1-7/8	3-1/4	CTC-3E3297	98.56
	9T5219		P-UB-10	1-7/8	3-1/4	CTC-8T3589	80.81
<b>BACKHOE BUCKET</b>							
	4T5601		P-UB-10	2	3-1/4	CTC-7X2821	140.11
	9T2751		P-UB-10	2	3-1/4	CTC-7X2821	140.11
	9T7893		P-UB-10	2	3-1/4	CTC-7X2821	140.11
	9T7894		P-UB-10	2	3-1/4	CTC-7X2821	140.11
<b>BACKHOE EXT STICK</b>							
	9T2215		P-UB-10	1-1/2	3	CTC-7X2737	108.60
	9T2215		P-UB-10	1-1/2	3	CTC-7X2745	108.60
	9T4809		P-UB-10	1-1/2	3	CTC-7X2737	108.60
	9T7893		P-UB-10	2	3-1/4	CTC-7X2821	140.11
<b>BACKHOE STICK</b>							
	6E0089		P-UB-10	2-1/2	4-1/4	CTC-3E3300	107.47
	9T2215		P-UB-10	1-1/2	3	CTC-7X2737	108.60
	9T7291		P-UB-10	2-1/2	4-1/4	CTC-3E3300	107.47
<b>BACKHOE SWING</b>							
	9T0420		P-UB-10	2-1/8	4	CTC-8T3593	70.99
	9T0421		P-UB-10	2-1/8	4	CTC-8T3593	70.99
<b>BACKHOE SWING LH</b>							
	9T0421		P-UB-10	2-1/8	4	CTC-1305923	158.53
<b>BACKHOE SWING RH</b>							
	9T0420		P-UB-10	2-1/8	4	CTC-1305923	158.53
<b>LOADER BUCKET MP</b>							
	9T4006		P-UB-10	1-1/2	3	CTC-7X2737	108.60
<b>LOADER LIFT</b>							
	6E0103		P-UB-10	1-7/8	3-1/4	CTC-3E3297	98.56
	9T0415		P-UB-10	1-7/8	3-1/4	CTC-3E3297	98.56

**CATERPILLAR®**





## REPLACEMENT KITS FOR CATERPILLAR® EQUIPMENT

<b>Backhoe Loaders</b>							
APPLICATION	CYL #	Misc-Parts, Instructions, etc.	CODE	ROD	BORE	KIT #	List \$
<b>MODEL 438</b>							
LOADER TILT							
	6E0113		P-UB-10	2	3-1/2	CTC-7X2783	102.97
	9T5371		P-UB-10	2	3-1/2	CTC-7X2783	102.97
	9T5371		P-UB-10	2	3-1/2	CTC-7X2822	95.53
STABILIZER							
	6E0119		P-UB-10	1-3/4	2-3/4	CTC-1539053	150.78
	9T0527		P-UB-10	1-3/4	2-3/4	CTC-7X2820	79.12
	9T9709		P-UB-10	1-3/4	2-3/4	CTC-7X2820	79.12
STEERING							
	9T1493		P-UB-10	1-7/8	3	CTC-8T3852	192.90
UNSPECIFIED APPLICATION							
	1070624		P-UB-10	1-7/8	3-1/4	CTC-3E3297	98.56
<b>MODEL 438B</b>							
BACKHOE BOOM							
	6E0274		P-UB-10	2-3/8	4-1/2	CTC-3E8877	177.68
BACKHOE BUCKET							
	1268308		I-UB-10	2-1/2	3-1/2	CTC-3E3299	134.08
	1268312		I-UB-10	2-3/4	3-3/4	CTC-1361990	173.89
	6E0275		I-UB-10	2-1/2	3-1/2	CTC-3E3299	134.08
	6E3693		I-UB-10	2-3/4	3-3/4	CTC-1361990	173.89
BACKHOE EXT BUCKET							
	6E1964		I-UB-10	2-1/2	3-1/2	CTC-3E3299	134.08
	6E2421		I-UB-10	2-3/4	3-3/4	CTC-9X2020	108.84
BACKHOE STICK							
	1097021		P-UB-10	2-1/2	4-1/2	CTC-1113300	136.57
	6E0290	Rod Bearing width- 0.98"	P-UB-10	2-1/2	4-1/2	CTC-1113300	136.57
	6E0290	Rod Bearing width- 1.25"	P-UB-10	2-1/2	4-1/2	CTC-1469860	161.26
	6E0404		P-UB-10	1-1/2	3	CTC-7X2737	108.60
BACKHOE SWING							
	1166861		P-UB-10	2	4	CTC-1113302	118.96
	6E0288		P-UB-10	2	4	CTC-1113302	118.96
BACKHOE SWING LH							
	6E1864		P-UB-10	2	4	CTC-1113302	118.96
LOADER BUCKET MP							
	9T4006		P-UB-10	1-1/2	3	CTC-7X2737	108.60
LOADER LIFT							
	6E0103		P-UB-10	1-7/8	3-1/4	CTC-3E3297	98.56
	9T0415		P-UB-10	1-7/8	3-1/4	CTC-3E3297	98.56
LOADER TILT							
	1071855		P-UB-10	2	3-1/2	CTC-7X2783	102.97
	6E0113		P-UB-10	2	3-1/2	CTC-7X2783	102.97
SIDESHIFT							
	1166858		P-UB-10	2	4	CTC-1113302	118.96
SIDESHIFT RH							
	1166858		P-UB-10	2	4	CTC-1113302	118.96
STABILIZER							
	1266950		P-UB-10	1-3/4	2-3/4	CTC-1539053	150.78
	6E3483		P-UB-10	1-3/4	2-3/4	CTC-1539053	150.78
UNSPECIFIED APPLICATION							
	1070624		P-UB-10	1-7/8	3-1/4	CTC-3E3297	98.56
<b>MODEL 438C</b>							
BACKHOE BOOM							
	6E0274		P-UB-10	2-3/8	4-1/2	CTC-3E8877	177.68
BACKHOE BUCKET							
	1268312		I-UB-10	2-3/4	3-3/4	CTC-1361990	173.89
	6E3693		I-UB-10	2-3/4	3-3/4	CTC-1361990	173.89

CATERPILLAR®



## REPLACEMENT KITS FOR CATERPILLAR® EQUIPMENT

Backhoe Loaders							
APPLICATION	CYL #	Misc-Parts, Instructions, etc.	CODE	ROD	BORE	KIT #	List \$
<b>MODEL 438C</b>							
BACKHOE EXT BUCKET							
	6E1964		I-UB-10	2-1/2	3-1/2	CTC-3E3299	134.08
	6E2421		I-UB-10	2-3/4	3-3/4	CTC-9X2020	108.84
BACKHOE STICK							
	1097021		P-UB-10	2-1/2	4-1/2	CTC-1113300	136.57
	6E0404		P-UB-10	1-1/2	3	CTC-7X2737	108.60
BACKHOE SWING							
	1166861		P-UB-10	2	4	CTC-1113302	118.96
LOADER BUCKET MP							
	9T4006		P-UB-10	1-1/2	3	CTC-7X2737	108.60
LOADER TILT							
	1071855		P-UB-10	2	3-1/2	CTC-7X2783	102.97
SIDESHIFT							
	1166858		P-UB-10	2	4	CTC-1113302	118.96
SIDESHIFT RH							
	1166858		P-UB-10	2	4	CTC-1113302	118.96
STABILIZER							
	1266950		P-UB-10	1-3/4	2-3/4	CTC-1539053	150.78
UNSPECIFIED APPLICATION							
	1070624		P-UB-10	1-7/8	3-1/4	CTC-3E3297	98.56
	1235087		P-UB-10	2	3-1/2	CTC-7X2783	102.97
	1235091		P-UB-10	2	3	CTC-7X2760	70.47
	9T8823		I-O-3	1	2	CTC-9T0418	82.99
<b>MODEL 446</b>							
BACKHOE BOOM							
	1118211		P-UB-10	2-5/8	5-1/4	CTC-1361908	176.83
BACKHOE BUCKET							
	9T6305		I-UB-10	2-3/4	3-3/4	CTC-9X2020	108.84
BACKHOE EXT BUCKET							
	1144828		I-UB-10	2-3/4	3-3/4	CTC-9X2020	108.84
BACKHOE EXT STICK							
	6E5383		P-UB-10	1-3/4	3	CTC-7X2825	53.69
	9T2107		P-UB-10	1-3/4	3	CTC-7X2825	53.69
BACKHOE STICK							
	1118213		P-UB-10	3	5-1/4	CTC-3E3293	177.73
	6E3062		P-UB-10	3	5-1/4	CTC-3E3293	177.73
	6E3314		P-UB-10	3	5-1/4	CTC-3E3293	177.73
	9T9186		P-UB-10	3	5-1/4	CTC-3E3293	177.73
BACKHOE SWING							
	1121765		P-UB-10	2	4	CTC-1113302	118.96
	6E5219		P-UB-10	2	4	CTC-1113302	118.96
BACKHOE SWING LH							
	9T1701		P-UB-10	2-1/8	4	CTC-9X2400	119.16
BACKHOE SWING RH							
	9T1230		P-UB-10	2-1/8	4	CTC-9X2400	119.16
LOADER LIFT							
	1117712		P-UB-10	2-1/4	3-3/4	CTC-1361897	159.18
	1257895		P-UB-10	2-1/4	3-3/4	CTC-1361897	159.18
	9T2997		P-UB-10	2	3-3/4	CTC-7X7938	104.60
LOADER TILT							
	1007844		P-UB-10	2	4	CTC-1113302	118.96
	1007844		P-UB-10	2	4	CTC-1328816	92.75
	9T2995		P-UB-10	2	4	CTC-1113302	118.96
	9T2995		P-UB-10	2	4	CTC-1328816	92.75
STABILIZER							
	9T2993		P-UB-10	2-1/8	4	CTC-9X2400	119.16
	9T2994		P-UB-10	2-1/8	4	CTC-9X2400	119.16

CATERPILLAR®



## REPLACEMENT KITS FOR CATERPILLAR® EQUIPMENT

<b>Backhoe Loaders</b>							
APPLICATION	CYL #	Misc-Parts, Instructions, etc.	CODE	ROD	BORE	KIT #	List \$
<b>MODEL 446</b>							
STABILIZER LH							
	1329701		P-UB-10	2-1/8	4	CTC-1305923	158.53
	9T2994		P-UB-10	2-1/8	4	CTC-1305923	158.53
STABILIZER RH							
	1329700		P-UB-10	2-1/8	4	CTC-1305923	158.53
	9T2993		P-UB-10	2-1/8	4	CTC-1305923	158.53
<b>MODEL 446B</b>							
BACKHOE BOOM							
	1118211		P-UB-10	2-5/8	5-1/4	CTC-1361908	176.83
BACKHOE BUCKET							
	1118217		I-UB-10	2-3/4	3-3/4	CTC-9X2020	108.84
	9T6305		I-UB-10	2-3/4	3-3/4	CTC-9X2020	108.84
BACKHOE EXT BUCKET							
	1144828		I-UB-10	2-3/4	3-3/4	CTC-9X2020	108.84
	9T4760		I-UB-10	2-3/4	3-3/4	CTC-9X2020	108.84
BACKHOE EXT STICK							
	6E5383		P-UB-10	1-3/4	3	CTC-7X2825	53.69
BACKHOE STICK							
	1118213		P-UB-10	3	5-1/4	CTC-3E3293	177.73
	1239707		P-UB-10	1-3/4	3	CTC-7X2825	53.69
	6E3062		P-UB-10	3	5-1/4	CTC-3E3293	177.73
	6E3314		P-UB-10	3	5-1/4	CTC-3E3293	177.73
	9T9186		P-UB-10	3	5-1/4	CTC-3E3293	177.73
BACKHOE SWING							
	1121765		P-UB-10	2	4	CTC-1113302	118.96
	6E5219		P-UB-10	2	4	CTC-1113302	118.96
BACKHOE SWING LH							
	9T1701		P-UB-10	2-1/8	4	CTC-9X2400	119.16
BACKHOE SWING RH							
	9T1230		P-UB-10	2-1/8	4	CTC-9X2400	119.16
LOADER LIFT							
	1117712		P-UB-10	2-1/4	3-3/4	CTC-1361897	159.18
	1257895		P-UB-10	2-1/4	3-3/4	CTC-1361897	159.18
	9T2997		P-UB-10	2	3-3/4	CTC-7X7938	104.60
LOADER TILT							
	1007844		P-UB-10	2	4	CTC-1113302	118.96
	1007844		P-UB-10	2	4	CTC-1328816	92.75
	9T2995		P-UB-10	2	4	CTC-1328816	92.75
SIDESHIFT							
	1121765		P-UB-10	2	4	CTC-1113302	118.96
STABILIZER LH							
	1329701		P-UB-10	2-1/8	4	CTC-1305923	158.53
	9T2994		P-UB-10	2-1/8	4	CTC-1305923	158.53
STABILIZER RH							
	1329700		P-UB-10	2-1/8	4	CTC-1305923	158.53
	9T2993		P-UB-10	2-1/8	4	CTC-1305923	158.53
<b>MODEL 446D</b>							
BACKHOE BOOM							
	DBL1-UP						
	1118211		P-UB-10	2-5/8	5-1/4	CTC-1118211K	106.86
BACKHOE BUCKET							
	DBL1-UP						
	2406029		I-UB-10	2-3/4	3-3/4	CTC-2406029K	74.12
	2406030		I-UB-10	2-3/4	3-3/4	CTC-2406030K	74.12
BACKHOE EXT STICK							
	DBL1-UP						
	2424278		P-UB-10	1-3/4	3	CTC-2342594	39.38

**CATERPILLAR®**



## REPLACEMENT KITS FOR CATERPILLAR® EQUIPMENT

<b>Backhoe Loaders</b>							
APPLICATION	CYL #	Misc-Parts, Instructions, etc.	CODE	ROD	BORE	KIT #	List \$
<b>MODEL 446D</b>							
<b>BACKHOE STICK</b>							
DBL1-UP							
	1118213		P-UB-10	3	5-1/4	CTC-2281776	108.40
<b>BACKHOE SWING</b>							
DBL1-426							
	1699531		P-UB-10	2	4	CTC-1699531K	69.03
DBL427-UP							
	2514296		P-UB-10	50 mm	100 mm	CTC-2332622	62.22
<b>LOADER BUCKET MP</b>							
DBL1-UP							
	2265540		I-U-10	1-1/2	3	CTC-2309357	55.43
	2681322		I-U-10	40 mm	3-1/2	CTC-2711529	24.94
	6Q2195		I,P-U-15	1-1/2	3-1/2	CTC-6Q2203	57.43
<b>LOADER LIFT</b>							
DBL1-UP							
	1257895		P-UB-10	2-1/4	3-3/4	CTC-1257895K	52.78
<b>LOADER TILT</b>							
DBL1-UP							
	1007844		P-UB-10	2	4	CTC-1007844K	43.01
<b>STABILIZER</b>							
DBL1-UP							
	1978079		P-UB-10	2-1/2	4	CTC-1978079K	49.22
	1978083		P-UB-10	2-1/2	4	CTC-1978083K	49.22
<b>STEERING</b>							
DBL1-UP							
	9T1834		P-UB-10	2-1/8	3-1/4	CTC-9T1834K	219.93
<b>UNSPECIFIED APPLICATION</b>							
DBL1-UP							
	2429893		P-UB-10	1-3/4	3-1/2	CTC-2401881	71.98
<b>Crawler Dozers</b>							
APPLICATION	CYL #	Misc-Parts, Instructions, etc.	CODE	ROD	BORE	KIT #	List \$
<b>MODEL 3P</b>							
<b>TILT</b>							
	9J8674		P-UB-10	1-1/2	3-1/2	CTC-7X2752	95.40
<b>MODEL 3S</b>							
<b>TILT</b>							
	8J6893		P-UB-10	2	4	CTC-7X2789	102.01
	9J8674		P-UB-10	1-1/2	3-1/2	CTC-7X2752	95.40
<b>MODEL 4S</b>							
<b>DOZER TILT</b>							
	5J1603		P-V-10	2	4-3/4	CTC-7X2677	117.03
<b>MODEL 5A</b>							
<b>LIFT</b>							
	7J8299		P-UB-10	2-1/2	4	CTC-7X2659	156.77
<b>MODEL 5S</b>							
<b>LIFT</b>							
	7J8302		P-UB-10	2-1/2	4	CTC-7X2659	156.77
<b>TILT</b>							
	2J1402		P-UB-10	3	6-1/2	CTC-7X2694	158.86
<b>MODEL 6</b>							
<b>LIFT</b>							
	7J7974		P-UB-10	1-1/2	4	CTC-7X2738	87.47
<b>RIPPER</b>							
	2K3663		P-UB-10	2-1/2	7-1/4	CTC-7X2661	180.93
<b>MODEL 6S</b>							
<b>TILT</b>							
	2J1402		P-UB-10	3	6-1/2	CTC-7X2694	158.86

CATERPILLAR®



## REPLACEMENT KITS FOR CATERPILLAR® EQUIPMENT

Crawler Dozers							
APPLICATION	CYL #	Misc-Parts, Instructions, etc.	CODE	ROD	BORE	KIT #	List \$
<b>MODEL 7A</b>							
TILT							
	5J7929		P-UB-10	2-1/2	6	CTC-7X2692	164.27
<b>MODEL 7S, 7U</b>							
DOZER TILT							
	3G4533		P-UB-10	3	6-1/2	CTC-1126550	177.23
	3J9694		P-U-10	3-1/2	8-1/4	CTC-7X2720	180.67
	6J9752		P-UB-10	3	6-1/2	CTC-1126550	177.23
	9J8748		P-UB-10	3	6-1/2	CTC-1126550	177.23
<b>MODEL 7SU</b>							
DOZER TILT							
	3G4533		P-UB-10	3	6-1/2	CTC-1126550	177.23
<b>MODEL 8A</b>							
DOZER LIFT							
	9J8802		P-UB-10	3-1/2	7-1/2	CTC-7X2722	185.75
<b>MODEL 8B</b>							
PIN PULLER							
	4J5057		P-V-10	1-1/4	4	CTC-8T1480	82.72
<b>MODEL 8D</b>							
RIPPER PIN PULLER							
	8J2071		P-UB-10	1-1/2	4	CTC-7X2738	87.47
<b>MODEL 8R</b>							
TILT							
	7J0192		P-UB-10	3-1/2	8-1/4	CTC-7X2721	291.15
<b>MODEL 8S</b>							
DOZER TILT							
	2J3894		P-U-10	3-1/2	8-1/4	CTC-7X2720	180.67
	3G5707		P-UB-10	3-1/2	8-1/4	CTC-7X2721	291.15
LIFT LH							
	5J9378		P-UB-10	2-1/2	5	CTC-7X2675	124.26
LIFT RH							
	5J9708		P-UB-10	2-1/2	5	CTC-7X2675	124.26
TILT							
	6J2472		P-UB-10	3-1/2	8-1/4	CTC-7X2728	174.95
	7J0192		P-UB-10	3-1/2	8-1/4	CTC-7X2721	291.15
	8J8682		P-UB-10	3-1/2	8-1/4	CTC-7X2721	291.15
<b>MODEL 8U</b>							
	6J2472		P-UB-10	3-1/2	8-1/4	CTC-7X2728	174.95
DOZER TILT							
	2J3894		P-U-10	3-1/2	8-1/4	CTC-7X2720	180.67
	3G5707		P-UB-10	3-1/2	8-1/4	CTC-7X2721	291.15
TILT							
	7J0192		P-UB-10	3-1/2	8-1/4	CTC-7X2721	291.15
	8J8682		P-UB-10	3-1/2	8-1/4	CTC-7X2721	291.15
<b>MODEL 9B</b>							
PIN PULLER							
	4J5057		P-V-10	1-1/4	4	CTC-8T1480	82.72
<b>MODEL 9R</b>							
TILT							
	6J1570		P-UB-10	3-1/2	8-1/4	CTC-7X2721	291.15
<b>MODEL 9S, 9U</b>							
DOZER TILT							
	2J6705		P-U-10	3-1/2	8-1/4	CTC-7X2720	180.67
	3G8661		P-UB-10	4	9-1/4	CTC-7X2799	357.79
TILT							
	6J1570		P-UB-10	3-1/2	8-1/4	CTC-7X2721	291.15

CATERPILLAR®



## REPLACEMENT KITS FOR CATERPILLAR® EQUIPMENT

<b>Crawler Dozers</b>							
APPLICATION	CYL #	Misc-Parts, Instructions, etc.	CODE	ROD	BORE	KIT #	List \$
<b>MODEL D2</b>							
UNSPECIFIED APPLICATION							
	4H6711		P-V-10	1-1/4	4	CTC-8T1480	82.72
<b>MODEL D3</b>							
ANGLING							
	8J0096		P-UB-10	1-1/2	3-1/2	CTC-7X2752	95.40
	9J8698		P-UB-10	1-1/2	3-1/2	CTC-7X2752	95.40
	9J8761		P-UB-10	1-1/2	3-1/2	CTC-7X2752	95.40
BACKHOE BOOM							
	8J5555		P-UB-10	2-1/4	4-1/2	CTC-7X2748	107.59
BACKHOE BUCKET							
	3G5905		P-UB-10	2-1/4	3-1/2	CTC-7X2818	90.21
	8J5642		P-UB-10	2-1/4	3-1/2	CTC-7X2818	90.21
BACKHOE STABILIZER							
	1U2655		P-UB-10	2	4	CTC-7X2789	102.01
	1U2656		P-UB-10	2	4	CTC-7X2789	102.01
	8J9481		P-UB-10	1-1/2	3-1/2	CTC-7X2752	95.40
BACKHOE STICK							
	8J5448		P-UB-10	2	4	CTC-7X2789	102.01
LIFT							
	7J9223		P-UB-10	1-1/2	3-1/2	CTC-7X2752	95.40
	7J9224		P-UB-10	1-1/2	3-1/2	CTC-7X2752	95.40
	8J6894		P-UB-10	1-1/2	3-1/2	CTC-7X2752	95.40
RIPPER							
	7J9920		P-UB-10	2	4	CTC-1328816	92.75
RIPPER PIN PULLER							
	4H6711		P-V-10	1-1/4	4	CTC-8T1480	82.72
TILT							
	8J0095		P-UB-10	1-1/2	3-1/2	CTC-7X2752	95.40
	8J6893		P-UB-10	2	4	CTC-7X2789	102.01
	9J4042		P-UB-10	1-1/2	3-1/2	CTC-7X2752	95.40
	9J8674		P-UB-10	1-1/2	3-1/2	CTC-7X2752	95.40
TRACK ADJUSTER							
			TRK ADJ			CTC-FIG4405	22.37
<b>MODEL D3 LGP</b>							
LIFT							
	8J6894		P-UB-10	1-1/2	3-1/2	CTC-7X2752	95.40
<b>MODEL D3B</b>							
ANGLING							
	9J8698		P-UB-10	1-1/2	3-1/2	CTC-1327058	103.88
	9J8761		P-UB-10	1-1/2	3-1/2	CTC-7X2752	95.40
BACKHOE BOOM/BUCKET							
	3G5767		P-UB-10	2-1/4	4-1/2	CTC-1326770	150.17
	3G5905		P-UB-10	2-1/4	3-1/2	CTC-1358166	171.50
BACKHOE STABILIZER							
	8J6903		P-UB-10	2	4	CTC-7X2789	102.01
	8J6904		P-UB-10	2	4	CTC-7X2789	102.01
	8J9481		P-UB-10	1-1/2	3-1/2	CTC-7X2752	95.40
BACKHOE STICK/BLADE SHIFT							
	3G5771		P-UB-10	2	4	CTC-1328816	92.75
LIFT							
	7J9223		P-UB-10	1-1/2	3-1/2	CTC-1327058	103.88
	8J6894		P-UB-10	1-1/2	3-1/2	CTC-7X2752	95.40
	9T4000		P-UB-10	1-1/2	4	CTC-7X2738	87.47
	9T6652		P-UB-10	1-1/2	3-1/2	CTC-1327058	103.88
RIPPER							
	7J9920		P-UB-10	2	4	CTC-1328816	92.75





## REPLACEMENT KITS FOR CATERPILLAR® EQUIPMENT

<b>Crawler Dozers</b>							
APPLICATION	CYL #	Misc-Parts, Instructions, etc.	CODE	ROD	BORE	KIT #	List \$
<b>MODEL D3B</b>							
STABILIZER							
	3G6792		P-UB-10	1-1/2	3-1/2	CTC-7X2752	95.40
STABILIZER LH							
	1U2656		P-UB-10	2	4	CTC-1328816	92.75
STABILIZER RH							
	1U2655		P-UB-10	2	4	CTC-1328816	92.75
TILT							
	8J0095		P-UB-10	1-1/2	3-1/2	CTC-7X2752	95.40
	8J6893		P-UB-10	2	4	CTC-1328816	92.75
	9J4042		P-UB-10	1-1/2	3-1/2	CTC-7X2752	95.40
	9J8674		P-UB-10	1-1/2	3-1/2	CTC-1327058	103.88
TRACK ADJUSTER							
			TRK ADJ			CTC-FIG4405	22.37
<b>MODEL D3C</b>							
ANGLING							
	1026237		P-UB-10	1-1/2	3-1/2	CTC-1327058	103.88
	1363155		P-UB-10	1-1/2	3-1/2	CTC-1327058	103.88
	1363156		P-UB-10	1-1/2	3-1/2	CTC-1327058	103.88
	1386859		P-UB-10	1-1/2	3	CTC-7X2751	64.04
	1390548		P-UB-10	1-1/2	3	CTC-7X2751	64.04
	9J8698		P-UB-10	1-1/2	3-1/2	CTC-1327058	103.88
BACKHOE BOOM							
	3G5767		P-UB-10	2-1/4	4-1/2	CTC-7X2748	107.59
BACKHOE BUCKET							
	3G5905		P-UB-10	2-1/4	3-1/2	CTC-7X2818	90.21
BACKHOE STABILIZER							
	3G6792		P-UB-10	1-1/2	3-1/2	CTC-7X2752	95.40
BACKHOE STICK							
	3G5771		P-UB-10	2	4	CTC-7X2789	102.01
LIFT							
	1412915		P-UB-10	1-1/2	3-1/2	CTC-1327058	103.88
	7J9223		P-UB-10	1-1/2	3-1/2	CTC-1327058	103.88
	8J6894		P-UB-10	1-1/2	3-1/2	CTC-7X2752	95.40
LIFT RH							
	6E0212		P-UB-10	2	4	CTC-1328816	92.75
RIPPER							
	7J9920		P-UB-10	2	4	CTC-1328816	92.75
TILT							
	1437219		P-UB-10	1-1/2	3-1/2	CTC-1327058	103.88
	8J0095		P-UB-10	1-1/2	3-1/2	CTC-7X2752	95.40
	8J6893		P-UB-10	2	4	CTC-1328816	92.75
	9J4042		P-UB-10	1-1/2	3-1/2	CTC-7X2752	95.40
	9J8674		P-UB-10	1-1/2	3-1/2	CTC-1327058	103.88
TRACK ADJUSTER							
			TRK ADJ			CTC-FIG4405	22.37
<b>MODEL D3G</b>							
ANGLING							
	BYR1-1323; CFC1-UP; CFF1-UP; JMH1-2051						
	2167388		P-UB-10	1-1/2	2-3/4	CTC-2167388K	43.33
	BYR1324-UP; JMH2052-UP						
	2590459		P-UB-10	1-1/2	2-3/4	CTC-2590459K	43.33
DOZER LIFT							
	JMH1-UP; BYR1-UP; CFC1-UP; CFF1-UP						
	1833721		P-UB-10	1-1/2	3-1/2	CTC-2465917	69.86
RIPPER-LH							
	BYR1-UP; CFC1-UP; CFF1-UP; JMH1-UP						
	1920893		P-UB-10	1-1/2	3	CTC-1920893K	48.71

CATERPILLAR®



## REPLACEMENT KITS FOR CATERPILLAR® EQUIPMENT

Crawler Dozers							
APPLICATION	CYL #	Misc-Parts, Instructions, etc.	CODE	ROD	BORE	KIT #	List \$
<b>MODEL D3G</b>							
RIPPER-RH							
BYR1-UP; CFC1-UP; CFF1-UP; JMH1-UP							
	1920891		P-UB-10	1-1/2	3	CTC-1920891K	48.71
TILT							
JMH1-UP; BYR1-UP; CFC1-UP; CFF1-UP							
	1838459		P-UB-10	1-1/2	3-1/2	CTC-1838459K	72.54
<b>MODEL D3K XL &amp; LGP</b>							
ANGLING							
LLL1-UP; FFF1-UP							
	2633745		P-UB-10	1-1/2	3	CTC-2633745K	40.73
	2633745		Bushing	1-1/2		CTC-4D0298	36.64
DOZER LIFT LH							
JTD1-UP; LLL1-UP; FFF1-UP							
	2764667		P-UB-10	1-1/2	3-1/2	CTC-2764667K	73.25
DOZER LIFT RH							
JTD1-UP; LLL1-UP; FFF1-UP							
	2634068		P-UB-10	1-1/2	3-1/2	CTC-2634068K	73.25
RIPPER LH							
JTD1-UP; LLL1-UP; FFF1-UP							
	2624418		P-UB-10	1-1/2	3	CTC-2624418K	40.73
RIPPER RH							
JTD1-UP; LLL1-UP; FFF1-UP							
	2624415		P-UB-10	1-1/2	3	CTC-2624415K	40.73
TILT							
JTD1-UP							
	3169205		P-UB-10	1-1/2	3	CTC-3169205K	40.73
JTD1-UP; LLL1-UP; FFF1-UP							
	2635008		P-UB-10	1-1/2	3-1/2	CTC-2635008K	73.25
	2635008		Bushing	1-1/2		CTC-4D0298	36.64
<b>MODEL D4B</b>							
ANGLING							
	9J8698		P-UB-10	1-1/2	3-1/2	CTC-7X2752	95.40
BACKHOE BOOM/BUCKET							
	3G5767		P-UB-10	2-1/4	4-1/2	CTC-1326770	150.17
	3G5905		P-UB-10	2-1/4	3-1/2	CTC-1358166	171.50
BACKHOE STICK/BLADE SHIFT							
	3G5771		P-UB-10	2	4	CTC-1328816	92.75
LIFT							
	7J9223		P-UB-10	1-1/2	3-1/2	CTC-1327058	103.88
	9T6652		P-UB-10	1-1/2	3-1/2	CTC-1327058	103.88
RIPPER							
	7J9920		P-UB-10	2	4	CTC-1328816	92.75
STABILIZER							
	3G6792		P-UB-10	1-1/2	3-1/2	CTC-7X2752	95.40
STABILIZER LH							
	1U2656		P-UB-10	2	4	CTC-1328816	92.75
STABILIZER RH							
	1U2655		P-UB-10	2	4	CTC-1328816	92.75
TILT							
	9J8674		P-UB-10	1-1/2	3-1/2	CTC-1327058	103.88
TRACK ADJUSTER							
			TRK ADJ			CTC-FIG4405	22.37
<b>MODEL D4C</b>							
ANGLING							
	1363156		P-UB-10	1-1/2	3-1/2	CTC-1327058	103.88
	1390548		P-UB-10	1-1/2	3	CTC-7X2751	64.04
	9J8698		P-UB-10	1-1/2	3-1/2	CTC-1327058	103.88

CATERPILLAR®



## REPLACEMENT KITS FOR CATERPILLAR® EQUIPMENT

<b>Crawler Dozers</b>							
APPLICATION	CYL #	Misc-Parts, Instructions, etc.	CODE	ROD	BORE	KIT #	List \$
<b>MODEL D4C</b>							
<b>LIFT</b>							
	1412915		P-UB-10	1-1/2	3-1/2	CTC-1327058	103.88
	7J9223		P-UB-10	1-1/2	3-1/2	CTC-1327058	103.88
	8J6894		P-UB-10	1-1/2	3-1/2	CTC-7X2752	95.40
<b>RIPPER</b>							
	7J9920		P-UB-10	2	4	CTC-1328816	92.75
<b>TILT</b>							
	1437219		P-UB-10	1-1/2	3-1/2	CTC-1327058	103.88
	9J8674		P-UB-10	1-1/2	3-1/2	CTC-1327058	103.88
<b>TRACK ADJUSTER</b>							
			TRK ADJ			CTC-FIG4400	48.04
			TRK ADJ			CTC-FIG4405	22.37
<b>MODEL D4D</b>							
<b>DOZER</b>							
	4J4890		P-U-10	2	3-1/2	CTC-7X2806	121.33
	4J4891		P-U-10	2	3-1/2	CTC-7X2806	121.33
	4T4575		P-UB-10	2	3-1/2	CTC-7X2769	112.87
	5J1603		P-V-10	2	4-3/4	CTC-7X2677	117.03
<b>DOZER LIFT</b>							
	8J6894		P-UB-10	1-1/2	3-1/2	CTC-7X2752	95.40
<b>RIPPER</b>							
	6J3308		P-UB-10	2-1/2	5-1/2	CTC-8T1374	93.39
	6J3308		P-UB-10	2-1/2	5-1/2	CTC-9X2050	100.69
<b>RIPPER PIN PULLER</b>							
	4H6711		P-V-10	1-1/4	4	CTC-8T1480	82.72
<b>TILT</b>							
	5J1603		P-V-10	2	4-3/4	CTC-7X2677	117.03
<b>TRACK ADJUSTER</b>							
			TRK ADJ			CTC-FIG4400	48.04
<b>MODEL D4E</b>							
<b>DOZER</b>							
	4T4574		P-UB-10	2	3-1/2	CTC-7X2769	112.87
	4T4575		P-UB-10	2	3-1/2	CTC-7X2769	112.87
<b>DOZER TILT</b>							
	5J1603		P-V-10	2	4-3/4	CTC-7X2677	117.03
<b>LIFT</b>							
	3G0892		P-UB-10	1-3/4	3-1/2	CTC-7X2762	100.06
	3G0892		P-UB-10	1-3/4	3-1/2	CTC-7X2784	56.35
	7J8302		P-UB-10	2-1/2	4	CTC-7X2659	156.77
	7J9223		P-UB-10	1-1/2	3-1/2	CTC-7X2752	95.40
	8J6894		P-UB-10	1-1/2	3-1/2	CTC-7X2752	95.40
<b>RIPPER</b>							
	3G5189		P-UB-10	2-1/2	5	CTC-7X2658	174.24
	6J3308		P-UB-10	2-1/2	5-1/2	CTC-8T1374	93.39
	6J3308		P-UB-10	2-1/2	5-1/2	CTC-9X2050	100.69
<b>RIPPER PIN PULLER</b>							
	4H6711		P-V-10	1-1/4	4	CTC-8T1480	82.72
<b>STEERING</b>							
	3G0892		P-UB-10	1-3/4	3-1/2	CTC-7X2762	100.06
	3G0892		P-UB-10	1-3/4	3-1/2	CTC-7X2784	56.35
	4T1574		P-UB-10	2	4	CTC-7X2789	102.01
	6E4892		P-UB-10	1-3/4	3-1/2	CTC-7X2784	56.35
	7J9685		P-UB-10	1-1/2	3-1/2	CTC-7X2812	104.03
<b>TILT</b>							
	5J1603		P-V-10	2	4-3/4	CTC-7X2677	117.03
<b>TRACK ADJUSTER</b>							
			TRK ADJ			CTC-FIG4400	48.04

**CATERPILLAR®**



## REPLACEMENT KITS FOR CATERPILLAR® EQUIPMENT

Crawler Dozers							
APPLICATION	CYL #	Misc-Parts, Instructions, etc.	CODE	ROD	BORE	KIT #	List \$
<b>MODEL D4G</b>							
ANGLING							
CFN1-UP; FDC1-UP; HYD1-UP; TLX1-UP							
2167388			P-UB-10	1-1/2	2-3/4	CTC-2167388K	43.33
HYD1719-UP; TLX859-UP							
2590459			P-UB-10	1-1/2	2-3/4	CTC-2590459K	43.33
DOZER LIFT							
CFN1-UP; FDC1-UP; HYD1-UP; TLX1-UP							
1833721			P-UB-10	1-1/2	3-1/2	CTC-2465917	69.86
RIPPER-LH							
CFN1-UP; FDC1-UP; HYD1-UP; TLX1-UP							
1920893			P-UB-10	1-1/2	3	CTC-1920893K	48.71
RIPPER-RH							
CFN1-UP; FDC1-UP; HYD1-UP; TLX1-UP							
1920891			P-UB-10	1-1/2	3	CTC-1920891K	48.71
TILT							
CFN1-UP; FDC1-UP; HYD1-UP; TLX1-UP							
1838459			P-UB-10	1-1/2	3-1/2	CTC-1838459K	72.54
<b>MODEL D4H</b>							
ANGLING							
1006174			P-UB-10	1-3/4	3-1/2	CTC-7X2784	56.35
4T1683			P-UB-10	1-3/4	3-1/2	CTC-7X2784	56.35
9T9247			P-UB-10	1-3/4	3-1/2	CTC-7X2784	56.35
DOZER LIFT							
3G9226			P-UB-10	2	4-1/4	CTC-7X2819	105.12
LIFT							
3G9226			P-UB-10	2	4-1/4	CTC-7X2819	105.12
4T4783			P-UB-10	2-1/4	3-3/4	CTC-7X2798	75.90
8J6894			P-UB-10	1-1/2	3-1/2	CTC-7X2752	95.40
RIPPER							
3G9892			P-UB-10	2	4	CTC-1328816	92.75
TILT							
1U2568			P-UB-10	2	4-1/4	CTC-7X2819	105.12
4T1063			P-UB-10	2	4-1/4	CTC-1378662	135.35
8J6893			P-UB-10	2	4	CTC-7X2789	102.01
9T8760			P-UB-10	2	4-1/4	CTC-1378662	135.35
9T8760			P-UB-10	2	4-1/4	CTC-7X2766	44.13
9T9557			P-UB-10	2	4-1/4	CTC-1378662	135.35
<b>MODEL D4K XL &amp; LGP</b>							
ANGLING							
MMM1-UP; RRR1-UP							
2633745			P-UB-10	1-1/2	3	CTC-2633745K	40.73
2633745			Bushing	1-1/2		CTC-4D0298	36.64
DOZER LIFT LH							
MMM1-UP; RRR1-UP							
2764667			P-UB-10	1-1/2	3-1/2	CTC-2764667K	73.25
DOZER LIFT RH							
MMM1-UP; RRR1-UP							
2634068			P-UB-10	1-1/2	3-1/2	CTC-2634068K	73.25
RIPPER LH							
MMM1-UP; RRR1-UP							
2624418			P-UB-10	1-1/2	3	CTC-2624418K	40.73
RIPPER RH							
MMM1-UP; RRR1-UP							
2624415			P-UB-10	1-1/2	3	CTC-2624415K	40.73

CATERPILLAR®



## REPLACEMENT KITS FOR CATERPILLAR® EQUIPMENT

Crawler Dozers							
APPLICATION	CYL #	Misc-Parts, Instructions, etc.	CODE	ROD	BORE	KIT #	List \$
<b>MODEL D4K XL &amp; LGP</b>							
TILT							
MMM1-UP; RRR1-UP							
	2635008		P-UB-10	1-1/2	3-1/2	CTC-2635008K	73.25
	2635008		Bushing	1-1/2		CTC-4D0298	36.64
<b>MODEL D4L</b>							
DOZER LIFT							
	3G9226		P-UB-10	2	4-1/4	CTC-7X2819	105.12
<b>MODEL D4TSKH</b>							
ANGLING							
	1006174		P-UB-10	1-3/4	3-1/2	CTC-7X2784	56.35
	9T9247		P-UB-10	1-3/4	3-1/2	CTC-7X2784	56.35
LIFT							
	6E0365		P-UB-10	2	4-1/4	CTC-7X2819	105.12
	6E0366		P-UB-10	2-1/2	4-3/4	CTC-1328811	161.44
TILT							
	9T9557		P-UB-10	2	4-1/4	CTC-1378662	135.35
<b>MODEL D5</b>							
DOZER							
	5J8174		P-UB-10	2-1/2	4-1/4	CTC-7X2664	89.40
	5J8176		P-UB-10	2-1/2	4-1/4	CTC-7X2664	89.40
LIFT							
	7J7974		P-UB-10	1-1/2	4	CTC-7X2738	87.47
	7J8299		P-UB-10	2-1/2	4	CTC-1318748	153.96
	7J8302		P-UB-10	2-1/2	4	CTC-1318748	153.96
RIPPER							
	2K3663		P-UB-10	2-1/2	7-1/4	CTC-7X2661	180.93
	8J1779		P-UB-10	2-1/2	7-1/4	CTC-1542502	193.44
TILT							
	2J1402		P-UB-10	3	6-1/2	CTC-1318740	173.30
	2J1402		P-UB-10	3	6-1/2	CTC-7X2694	158.86
TRACK ADJUSTER							
			TRK ADJ			CTC-FIG4400	48.04
<b>MODEL D5B</b>							
LIFT							
	7J7974		P-UB-10	1-1/2	4	CTC-7X2738	87.47
	7J8299		P-UB-10	2-1/2	4	CTC-1318748	153.96
	7J8302		P-UB-10	2-1/2	4	CTC-7X2659	156.77
	8J6868		P-UB-10	2-1/2	4	CTC-7X2659	156.77
RIPPER							
	8J1779		P-UB-10	2-1/2	7-1/4	CTC-1542502	193.44
TILT							
	2J1402		P-UB-10	3	6-1/2	CTC-1318733	206.11
	2J1402		P-UB-10	3	6-1/2	CTC-7X2694	158.86
	7J9695		P-UB-10	2-1/2	5-1/2	CTC-9X2050	100.69
TRACK ADJUSTER							
			TRK ADJ			CTC-FIG4400	48.04
<b>MODEL D5C</b>							
ANGLING							
	1363156		P-UB-10	1-1/2	3-1/2	CTC-1327058	103.88
	1390548		P-UB-10	1-1/2	3	CTC-7X2751	64.04
	9J8698		P-UB-10	1-1/2	3-1/2	CTC-1327058	103.88
LIFT							
	1412915		P-UB-10	1-1/2	3-1/2	CTC-1327058	103.88
	7J9223		P-UB-10	1-1/2	3-1/2	CTC-1327058	103.88
RIPPER							
	7J9920		P-UB-10	2	4	CTC-1328816	92.75

**CATERPILLAR®**



## REPLACEMENT KITS FOR CATERPILLAR® EQUIPMENT

Crawler Dozers							
APPLICATION	CYL #	Misc-Parts, Instructions, etc.	CODE	ROD	BORE	KIT #	List \$
<b>MODEL D5C</b>							
TILT							
	1437219		P-UB-10	1-1/2	3-1/2	CTC-1327058	103.88
	9J8674		P-UB-10	1-1/2	3-1/2	CTC-1327058	103.88
<b>MODEL D5E</b>							
LIFT							
	8J6868		P-UB-10	2-1/2	4	CTC-7X2659	156.77
RIPPER							
	8J1779		P-UB-10	2-1/2	7-1/4	CTC-1542502	193.44
TRACK ADJUSTER							
			TRK ADJ			CTC-FIG4400	48.04
<b>MODEL D5G</b>							
ANGLING							
	FDH1141-UP; FDW651-UP; RKG1-2121; WGB1-2700						
	2167388		P-UB-10	1-1/2	2-3/4	CTC-2167388K	43.33
	FDH1-UP; FDW1-UP						
	2011056		P-UB-10	1-1/2	2-3/4	CTC-2011056K	43.33
	RKG2122-UP; WGB2701-UP						
	2590459		P-UB-10	1-1/2	2-3/4	CTC-2590459K	43.33
DOZER LIFT							
	FDH1-UP; FDW1-UP; RKG1-UP; WGB1-UP						
	1833721		P-UB-10	1-1/2	3-1/2	CTC-2465917	69.86
RIPPER-LH							
	FDH1-UP; FDW1-UP; RKG1-UP; WGB1-UP						
	1920893		P-UB-10	1-1/2	3	CTC-1920893K	48.71
RIPPER-RH							
	FDH1-UP; FDW1-UP; RKG1-UP; WGB1-UP						
	1920891		P-UB-10	1-1/2	3	CTC-1920891K	48.71
TILT							
	FDH1-UP; FDW1-UP; RKG1-UP; WGB1-UP						
	1838459		P-UB-10	1-1/2	3-1/2	CTC-1838459K	72.54
<b>MODEL D5H</b>							
ANGLING							
	4T1666		P-UB-10	2	4	CTC-7X2789	102.01
	9T9273		P-UB-10	2	4	CTC-1113302	118.96
LIFT							
	1153524		P-UB-10	2-1/4	3-3/4	CTC-1361897	159.18
	1U1839		P-UB-10	2-1/4	3-3/4	CTC-1361897	159.18
	1U2568		P-UB-10	2	4-1/4	CTC-7X2819	105.12
	3G5909		P-UB-10	2	4	CTC-7X2789	102.01
	4T1089		P-UB-10	2-1/4	3-3/4	CTC-1361897	159.18
	4T1659		P-UB-10	2-1/4	4-1/2	CTC-1326770	150.17
	6E5400		P-UB-10	2-1/4	4-1/2	CTC-1354392	140.37
RIPPER							
	3G5909		P-UB-10	2	4	CTC-1328816	92.75
	9T2716		P-UB-10	2-1/2	5	CTC-7X2658	174.24
TILT							
	1U3991		P-UB-10	3	6-1/2	CTC-1126550	177.23
	1U3991		P-UB-10	3	6-1/2	CTC-8T1408	80.75
	4T1625		P-UB-10	2-1/4	4-3/4	CTC-1318778	140.11
	4T2613		P-UB-10	2-1/2	5	CTC-1315118	177.89
	4T2613		P-UB-10	2-1/2	5	CTC-7X2658	174.24
<b>MODEL D5K XL &amp; LGP</b>							
ANGLING							
	WWW1-UP; YYY1-UP						
	2633745		P-UB-10	1-1/2	3	CTC-2633745K	40.73
	2633745		Bushing	1-1/2		CTC-4D0298	36.64





## REPLACEMENT KITS FOR CATERPILLAR® EQUIPMENT

<b>Crawler Dozers</b>							
APPLICATION	CYL #	Misc-Parts, Instructions, etc.	CODE	ROD	BORE	KIT #	List \$
<b>MODEL D5K XL &amp; LGP</b>							
<b>DOZER LIFT LH</b>							
JLF1-UP; WWW1-UP; YYY1-UP							
2764667			P-UB-10	1-1/2	3-1/2	CTC-2764667K	73.25
<b>DOZER LIFT RH</b>							
JLF1-UP; WWW1-UP; YYY1-UP							
2634068			P-UB-10	1-1/2	3-1/2	CTC-2634068K	73.25
<b>RIPPER LH</b>							
JLF1-UP; WWW1-UP; YYY1-UP							
2624418			P-UB-10	1-1/2	3	CTC-2624418K	40.73
<b>RIPPER RH</b>							
JLF1-UP; WWW1-UP; YYY1-UP							
2624415			P-UB-10	1-1/2	3	CTC-2624415K	40.73
<b>TILT</b>							
JLF1-UP							
3169205			P-UB-10	1-1/2	3	CTC-3169205K	40.73
JLF1-UP; WWW1-UP; YYY1-UP							
2635008			P-UB-10	1-1/2	3-1/2	CTC-2635008K	73.25
2635008			Bushing	1-1/2		CTC-4D0298	36.64
<b>MODEL D5M</b>							
<b>ANGLING</b>							
1061286			P-UB-10	1-3/4	3-1/2	CTC-7X2784	56.35
1378456			P-UB-10	1-3/4	3-1/2	CTC-7X2784	56.35
1526482			P-UB-10	1-3/4	3-1/2	CTC-7X2784	56.35
<b>LIFT</b>							
1059822			P-UB-10	2	4-1/4	CTC-1378662	135.35
1607610			P-UB-10	2-1/2	4-3/4	CTC-1328811	161.44
6E0366			P-UB-10	2-1/2	4-3/4	CTC-1328811	161.44
<b>RIPPER</b>							
3G9892			P-UB-10	2	4	CTC-1328816	92.75
<b>MODEL D5N</b>							
<b>ANGLING</b>							
AGG1-UP; AKD1-UP; CFH1-150; CKT1-292							
1526482			P-UB-10	1-3/4	3-1/2	CTC-2401881	71.98
AGG1-UP; AKD1-UP; CFH151-UP; CKT293-UP							
2432058			P-UB-10	1-3/4	3-1/2	CTC-2432058K	75.02
<b>DOZER LIFT</b>							
AGG1-UP; AKD1-UP; CFH1-UP; CKT1-UP							
1677551			P-UB-10	2	4-1/4	CTC-1677551K	50.16
<b>DOZER TILT</b>							
1600045	Includes 0.99" & 1.24" Wear ring		P-UB-10	2-1/2	4-3/4	CTC-1600045K	101.38
1600045	CHG 00-01, 0.99" Wear ring width		P-UB-10	2-1/2	4-3/4	CTC-1864382	94.88
1600045	CHG 06-UP, 1.24" Wear ring width		P-UB-10	2-1/2	4-3/4	CTC-1864399	84.06
<b>RIPPER</b>							
AGG1-UP; AKD1-UP; CFH1-UP; CKT1-UP							
3G9892			P-UB-10	2	4	CTC-2339205	53.31
<b>MODEL D5TSKH</b>							
<b>ANGLING</b>							
9T9273			P-UB-10	2	4	CTC-1113302	118.96
<b>LIFT</b>							
6E0366			P-UB-10	2-1/2	4-3/4	CTC-1328811	161.44
<b>MODEL D6</b>							
<b>RIPPER</b>							
2K3663			P-UB-10	2-1/2	7-1/4	CTC-7X2661	180.93
<b>RIPPER LIFT</b>							
8J1779			P-UB-10	2-1/2	7-1/4	CTC-7X2661	180.93

**CATERPILLAR®**



## REPLACEMENT KITS FOR CATERPILLAR® EQUIPMENT

Crawler Dozers							
APPLICATION	CYL #	Misc-Parts, Instructions, etc.	CODE	ROD	BORE	KIT #	List \$
<b>MODEL D6 LGP</b>							
LIFT	8J6868		P-UB-10	2-1/2	4	CTC-7X2659	156.77
<b>MODEL D6B</b>							
LIFT	5J8173		P-UB-10	2-1/2	4-1/4	CTC-7X2664	89.40
RIPPER	2K3663		P-UB-10	2-1/2	7-1/4	CTC-7X2661	180.93
RIPPER LIFT	8J1779		P-UB-10	2-1/2	7-1/4	CTC-7X2661	180.93
TILT	2J1402		P-UB-10	3	6-1/2	CTC-1318733	206.11
	2J1402		P-UB-10	3	6-1/2	CTC-7X2694	158.86
TRACK ADJUSTER			TRK ADJ			CTC-FIG4400	48.04
<b>MODEL D6C</b>							
BACKHOE STICK/BLADE SHIFT							
	8J5448		P-UB-10	2	4	CTC-1328816	92.75
DOZER							
	5J8172		P-UB-10	2-1/2	4-1/4	CTC-7X2664	89.40
	5J8173		P-UB-10	2-1/2	4-1/4	CTC-7X2664	89.40
DOZER LIFT							
	4J4891		P-U-10	2	3-1/2	CTC-7X2806	121.33
DOZER TILT							
	1U3495		P-UB-10	2-1/2	6	CTC-7X2674	129.22
	2J1402		P-UB-10	3	6-1/2	CTC-7X2694	158.86
	5J1603		P-V-10	2	4-3/4	CTC-7X2677	117.03
	7J3171		P-UB-10	2-1/2	6	CTC-7X2674	129.22
	7J3172		P-UB-10	2-1/2	6	CTC-7X2674	129.22
LIFT							
	7J7974		P-UB-10	1-1/2	4	CTC-7X2738	87.47
	7J8302		P-UB-10	2-1/2	4	CTC-1318748	153.96
	8J6868		P-UB-10	2-1/2	4	CTC-1318748	153.96
RIPPER							
	2K3663		P-UB-10	2-1/2	7-1/4	CTC-7X2661	180.93
	6J3308		P-UB-10	2-1/2	5-1/2	CTC-8T1374	93.39
	8J1779		P-UB-10	2-1/2	7-1/4	CTC-1542502	193.44
TILT							
	2J1402		P-UB-10	3	6-1/2	CTC-1318733	206.11
TRACK ADJUSTER							
			TRK ADJ			CTC-FIG3400	59.82
<b>MODEL D6D</b>							
BACKHOE STICK/BLADE SHIFT							
	8J5448		P-UB-10	2	4	CTC-1328816	92.75
DOZER TILT							
	1U3495		P-UB-10	2-1/2	6	CTC-7X2674	129.22
	2J1402		P-UB-10	3	6-1/2	CTC-7X2694	158.86
	7J3171		P-UB-10	2-1/2	6	CTC-7X2674	129.22
	7J3172		P-UB-10	2-1/2	6	CTC-7X2674	129.22
DOZER TILT RH							
	7J9695		P-UB-10	2-1/2	5-1/2	CTC-8T1374	93.39
LIFT							
	7J7974		P-UB-10	1-1/2	4	CTC-7X2738	87.47
	7J8302		P-UB-10	2-1/2	4	CTC-1318748	153.96
	8J6868		P-UB-10	2-1/2	4	CTC-1318748	153.96
RIPPER							
	8J1779		P-UB-10	2-1/2	7-1/4	CTC-1542502	193.44

CATERPILLAR®



## REPLACEMENT KITS FOR CATERPILLAR® EQUIPMENT

<b>Crawler Dozers</b>							
APPLICATION	CYL #	Misc-Parts, Instructions, etc.	CODE	ROD	BORE	KIT #	List \$
<b>MODEL D6D</b>							
TILT							
	1U3495		P-UB-10	2-1/2	6	CTC-7X2692	164.27
	2J1402		P-UB-10	3	6-1/2	CTC-1318733	206.11
	7J3171		P-UB-10	2-1/2	6	CTC-7X2692	164.27
	7J9695		P-UB-10	2-1/2	5-1/2	CTC-9X2050	100.69
	9T2797		P-UB-10	2-1/2	6	CTC-7X2674	129.22
TILT LH							
	6J0518		P-UB-10	2-1/2	6	CTC-7X2692	164.27
	7J3172		P-UB-10	2-1/2	6	CTC-7X2692	164.27
TILT RH							
	6J0517		P-UB-10	2-1/2	6	CTC-7X2692	164.27
TRACK ADJUSTER							
			TRK ADJ			CTC-FIG3400	59.82
<b>MODEL D6E, D6G</b>							
LIFT							
	8J6868		P-UB-10	2-1/2	4	CTC-1318748	153.96
RIPPER							
	1306135		P-UB-10	2-1/2	7-1/4	CTC-1542502	193.44
	8J1779		P-UB-10	2-1/2	7-1/4	CTC-1542502	193.44
TILT							
	1U3495		P-UB-10	2-1/2	6	CTC-7X2674	129.22
	1U3495		P-UB-10	2-1/2	6	CTC-7X2692	164.27
	9T2797		P-UB-10	2-1/2	6	CTC-7X2674	129.22
UNSPECIFIED APPLICATION							
	2J1402		P-UB-10	3	6-1/2	CTC-1318733	206.11
<b>MODEL D6H</b>							
DOZER							
	1U3989		P-UB-10	2-1/2	3-3/4	CTC-1318700	150.91
	1U3990		P-UB-10	2-1/2	3-3/4	CTC-1318700	150.91
	4Y3807		P-UB-10	2-1/2	3-3/4	CTC-1318700	150.91
	9T8952		P-UB-10	2-1/2	4	CTC-1353223	160.41
	9T8996		P-UB-10	2-1/2	4	CTC-1353223	160.41
DOZER TILT							
	9T6095		P-UB-10	2-1/2	6	CTC-7X2655	113.60
RIPPER							
	9T2716		P-UB-10	2-1/2	5	CTC-7X2658	174.24
TILT							
	1U3991		P-UB-10	3	6-1/2	CTC-1126550	177.23
	1U3991		P-UB-10	3	6-1/2	CTC-7X2694	158.86
	1U3992		P-UB-10	2-1/2	6	CTC-7X2655	113.60
	1U3992		P-UB-14	2-1/2	6	CTC-7X2836	256.92
	3G2798		P-UB-10	2-1/2	5-1/2	CTC-7X2671	148.14
	9T6095		P-UB-10	2-1/2	6	CTC-1315164	203.42
	9T8760		P-UB-10	2	4-1/4	CTC-7X2766	44.13
<b>MODEL D6K LGP</b>							
ANGLING							
	DHA1-UP; FBH1-UP						
	2692728		P-UB-10	45 mm	90 mm	CTC-2692728K	108.38
DOZER LIFT							
	DHA1-UP; FBH1-UP						
	2692730		P-UB-10	60 mm	110 mm	CTC-2692730K	152.73
DOZER TILT							
	DHA1-UP; FBH1-UP						
	2692729		P-UB-10	65 mm	120 mm	CTC-2692729K	82.60

**CATERPILLAR®**



## REPLACEMENT KITS FOR CATERPILLAR® EQUIPMENT

Crawler Dozers							
APPLICATION	CYL #	Misc-Parts, Instructions, etc.	CODE	ROD	BORE	KIT #	List \$
<b>MODEL D6K LGP</b>							
RIPPER							
4041-UP							
	2270842		P-UB-10	2-1/2	5	CTC-2422542	80.81
	3255723		P-UB-10	2-1/2	5	CTC-3255723K	76.42
<b>MODEL D6K XL</b>							
ANGLING							
DHA1-UP; FBH1-UP; HMG1-UP							
	2692728		P-UB-10	45 mm	90 mm	CTC-2692728K	108.38
DOZER LIFT							
DHA1-UP; FBH1-UP; HMG1-UP							
	2692730		P-UB-10	60 mm	110 mm	CTC-2692730K	152.73
DOZER TILT							
DHA1-UP; FBH1-UP; HMG1-UP							
	2692729		P-UB-10	65 mm	120 mm	CTC-2692729K	82.60
RIPPER							
4041-UP							
	2270842		P-UB-10	2-1/2	5	CTC-2422542	80.81
4041-UP; HMG1-UP							
	3255723		P-UB-10	2-1/2	5	CTC-3255723K	76.42
<b>MODEL D6M</b>							
ANGLING							
	1103786		P-UB-10	2	4	CTC-1113302	118.96
	1526485		P-UB-10	2	4	CTC-1113302	118.96
LIFT							
	1103269		P-UB-10	2-1/4	4-1/2	CTC-1326770	150.17
	1153524		P-UB-10	2-1/4	3-3/4	CTC-1361897	159.18
RIPPER							
	3G5909		P-UB-10	2	4	CTC-1328816	92.75
	9T2716		P-UB-10	2-1/2	5	CTC-7X2658	174.24
TILT							
	1600054		P-UB-10	2-1/2	5-1/2	CTC-7X2653	162.45
UNSPECIFIED APPLICATION							
	1375107		P-UB-10	2	4	CTC-1113302	118.96
<b>MODEL D6N</b>							
ANGLING							
AKM1-UP; ALH1-UP; ALR1-UP; ALY1-UP; CBF1-UP; CBJ1-UP; CBL1-UP; CCG1-UP; CCK1-UP; CCS1-UP; DJA1-UP; DJY1-UP							
	2280320		P-UB-10	2	4	CTC-2280320K	70.57
AKM1-UP; ALY1-UP; CCK1-UP; DJA1-UP; DJY1-UP; GHS1-UP; JAH1-UP; LJR1-UP; MLW1-UP							
	3217048		P-UB-10	2	4	CTC-3217048K	70.69
ALH1-UP; ALR1-UP							
	1526485		P-UB-10	2	4	CTC-2409538	73.72
DOZER LIFT							
AKM1-1885; ALY1-2181							
	1922811		P-UB-10	2-1/4	4-1/2	CTC-2417585	73.70
AKM1-UP; ALH1-UP; ALR1-UP; ALY1-UP; CBJ1-UP; CCK1-UP							
	1U1839		P-UB-10	2-1/4	3-3/4	CTC-1U1839K	56.57
AKM1-UP; ALH1-UP; ALY1-UP; CBF1-UP; CBJ1-UP; CBL1-UP; CCG1-UP; CCK1-UP; CCS1-UP; DJA1-UP; DJY1-UP; GHS1-UP; JAH1-UP; LJR1-UP; MLW1-UP							
	1103269		P-UB-10	2-1/4	4-1/2	CTC-2417584	75.10
AKM1-UP; ALH1-UP; CBJ1-UP; CCK1-UP							
	1153524		P-UB-10	2-1/4	3-3/4	CTC-1153524K	56.57
DJA1-UP; DJY1-UP; GHS1-UP; JAH1-UP; LJR1-UP; MLW1-UP							
	2758416		P-UB-10	2-1/4	3-3/4	CTC-2758416K	56.57
DOZER TILT							
AKM1-UP; ALH1-UP; ALR1-UP; ALY1-UP; CBF1-UP; CBJ1-UP; CBL1-UP; CCG1-UP; CCK1-UP; CCS1-UP; DJA1-UP; DJY1-UP; JAH1-UP; LJR1-UP							
	1600054		P-UB-10	2-1/2	5-1/2	CTC-2422539	79.98

**CATERPILLAR®**



## REPLACEMENT KITS FOR CATERPILLAR® EQUIPMENT

<b>Crawler Dozers</b>							
APPLICATION	CYL #	Misc-Parts, Instructions, etc.	CODE	ROD	BORE	KIT #	List \$
<b>MODEL D6N</b>							
DOZER TILT							
AKM1-UP; ALH1-UP; CBF1-UP; CBJ1-UP; CBL1-UP; CCG1-UP; CCK1-UP; CCS1-UP; DJA1-UP; DJY1-UP							
	1153523		P-UB-10	3	6-1/2	CTC-1153523K	118.85
DJA1-UP; DJY1-UP; GHS1-UP; JAH1-UP; LJR1-UP; MLW1-UP							
	2339134		P-UB-10	3	6-1/2	CTC-2339134K	121.95
	3284267		P-UB-10	2-1/2	5-1/2	CTC-3284267K	79.98
RIPPER LIFT							
AKM1-UP; ALH1-UP; ALR1-UP; ALY1-UP; CBF1-UP; CBJ1-UP; CBL1-UP; CCG1-UP; CCK1-UP; CCS1-UP							
	9T2716		P-UB-10	2-1/2	5	CTC-2422542	80.81
AKM1-UP; ALH1-UP; ALR1-UP; ALY1-UP; CBF1-UP; CBL1-UP; CCG1-UP; CCK1-UP; CCS1-UP; DJA1-UP; DJY1-UP; JAH1-UP							
	2270842		P-UB-10	2-1/2	5	CTC-2270842K	76.20
DJA1-UP; DJY1-UP; GHS1-UP; JAH1-UP; LJR1-UP; MLW1-UP							
	3255723		P-UB-10	2-1/2	5	CTC-3255723K	76.42
<b>MODEL D6R</b>							
DOZER							
	1278931		P-UB-10	2-1/2	4	CTC-1353223	160.41
	1294258		P-UB-10	2-1/2	4	CTC-1353223	160.41
RIPPER							
	9T2716		P-UB-10	2-1/2	5	CTC-7X2658	174.24
TILT							
	1U3991		P-UB-10	3	6-1/2	CTC-1126550	177.23
	1U3991		P-UB-10	3	6-1/2	CTC-8T1408	80.75
	9T6095		P-UB-10	2-1/2	6	CTC-1315164	203.42
	9T6095		P-UB-10	2-1/2	6	CTC-7X2655	113.60
<b>MODEL D6T</b>							
ANGLING							
DJG1-UP; JWD1-UP; RLW1-UP; WCG1-UP; WFH1-UP; ZEB1-UP							
	2871973		P-UB-10	2-1/4	4	CTC-2871973K	78.48
DOZER ANGLING							
DJG1-UP; JWD1-UP; RLW1-UP; WCG1-UP; WFH1-UP; ZEB1-UP							
	2278893		P-UB-10	2-1/2	5-1/4	CTC-2278893K	80.61
GCT1-UP; JHB1-UP; KJL1-UP; LAE1-UP; LAY1-UP; PEZ1-UP; SKL1-UP; SMC1-UP							
	2270841		P-UB-10	2-1/2	6	CTC-2270841K	72.89
DOZER LIFT							
DJG1-UP; JWD1-UP; RLW1-UP; WFH1-UP; ZEB1-UP							
	2270994		P-UB-10	2-1/2	4	CTC-2270994K	177.35
GCT1-UP; JHB1-UP; LAE1-UP; LAY1-UP; LBD1-UP; LKJ1-UP; PEZ1-UP; SKL1-UP; SMC1-UP							
	2270844		P-UB-10	2-1/2	4	CTC-2270844K	90.84
JWD1-UP; RLW1-UP; WCG1-UP; ZEB1-UP							
	2330478		P-UB-10	2-1/2	4	CTC-2330478K	177.35
KJL1-UP; LAE1-UP; LBD1-UP; LKJ1-UP; PEZ1-UP							
	2270843		P-UB-10	2-1/2	4	CTC-2270843K	90.84
DOZER TILT							
JHB1-UP; KJL1-UP; LAE1-UP; LAY1-UP; LBD1-UP; LKJ1-UP; PEZ1-UP; SKL1-UP; SMC1-UP							
	2339134		P-UB-10	3	6-1/2	CTC-2339134K	121.95
RIPPER LIFT							
DJG1-UP; GCT1-UP; JHB1-UP; JWD1-UP; KJL1-UP; LAE1-UP; LAY1-UP; LBD1-UP; LKJ1-UP; PEZ1-UP; RLW1-UP; SKL1-UP; SMC1-UP; WCG1-UP; WFH1-UP; ZEB1-UP							
	2270842		P-UB-10	2-1/2	5	CTC-2270842K	76.20
	3255723		P-UB-10	2-1/2	5	CTC-3255723K	76.42
<b>MODEL D7</b>							
TRACK ADJUSTER							
			TRK ADJ			CTC-FIG3400	59.82
<b>MODEL D7 LGP</b>							
LIFT LH							
	9J4887		P-UB-10	2-1/2	4-3/4	CTC-1014201	133.98

**CATERPILLAR®**



## REPLACEMENT KITS FOR CATERPILLAR® EQUIPMENT

Crawler Dozers							
APPLICATION	CYL #	Misc-Parts, Instructions, etc.	CODE	ROD	BORE	KIT #	List \$
<b>MODEL D7 LGP</b>							
LIFT RH							
	9J4888		P-UB-10	2-1/2	4-3/4	CTC-1014201	133.98
<b>MODEL D7A, D7B, D7C, D7D, D7E</b>							
DOZER LIFT							
	3R6781		P-UB-10	2-1/2	4-3/4	CTC-7X2660	179.61
DOZER LIFT LH							
	1U2133		P-UB-10	2-1/2	4-3/4	CTC-7X2660	179.61
	1U2136		P-UB-10	2-1/2	4-3/4	CTC-7X2660	179.61
DOZER LIFT RH							
	1U2134		P-UB-10	2-1/2	4-3/4	CTC-7X2660	179.61
	1U2135		P-UB-10	2-1/2	4-3/4	CTC-7X2660	179.61
DOZER TILT							
	2J6783		P-U-10	3-1/2	8-1/4	CTC-7X2720	180.67
	3J9694		P-U-10	3-1/2	8-1/4	CTC-7X2720	180.67
	3R6770		P-U-10	3-1/2	8-1/4	CTC-7X2720	180.67
	9J8748		P-UB-10	3	6-1/2	CTC-7X2694	158.86
LIFT							
	3J3271		P-UB-10	2-1/2	6	CTC-7X2679	138.16
	4J6177		P-UB-10	2-1/2	4-3/4	CTC-1014201	133.98
	4J6177		P-UB-10	2-1/2	4-3/4	CTC-7X2660	179.61
RIPPER							
	3J6439		P-UB-10	2-1/2	6	CTC-7X2679	138.16
RIPPER LIFT							
	3R6724	D7E only	P-UB-10	2-1/2	6	CTC-7X2679	138.16
	4T9290		P-UB-10	2-1/2	6	CTC-7X2655	113.60
TILT							
	5J7929		P-UB-10	2-1/2	6	CTC-7X2692	164.27
	6J9752		P-UB-10	3	6-1/2	CTC-1126550	177.23
TRACK ADJUSTER							
		D7C, D7D only	TRK ADJ			CTC-FIG3400	59.82
		D7E only	TRK ADJ			CTC-FIG3404	46.26
<b>MODEL D7F</b>							
DOZER LH							
	1041944		P-UB-10	2-1/2	4-3/4	CTC-1700221	141.65
	1U2136		P-UB-10	2-1/2	4-3/4	CTC-7X2773	178.40
DOZER LIFT							
	3R6781		P-UB-10	2-1/2	4-3/4	CTC-7X2660	179.61
DOZER LIFT LH							
	1U2133		P-UB-10	2-1/2	4-3/4	CTC-7X2660	179.61
	1U2136		P-UB-10	2-1/2	4-3/4	CTC-7X2660	179.61
DOZER LIFT RH							
	1U2134		P-UB-10	2-1/2	4-3/4	CTC-7X2660	179.61
	1U2135		P-UB-10	2-1/2	4-3/4	CTC-7X2660	179.61
DOZER RH							
	1041943		P-UB-10	2-1/2	4-3/4	CTC-1700221	141.65
	1U2135		P-UB-10	2-1/2	4-3/4	CTC-7X2773	178.40
DOZER TILT							
	2J6783		P-U-10	3-1/2	8-1/4	CTC-7X2720	180.67
	3J9694		P-U-10	3-1/2	8-1/4	CTC-7X2720	180.67
	3R6770		P-U-10	3-1/2	8-1/4	CTC-7X2720	180.67
	9J8748		P-UB-10	3	6-1/2	CTC-7X2694	158.86
LIFT							
	3J3271		P-UB-10	2-1/2	6	CTC-7X2679	138.16
	4J6177		P-UB-10	2-1/2	4-3/4	CTC-7X2660	179.61
LIFT LH							
	7J3334		P-UB-10	2-1/2	4-3/4	CTC-7X2773	178.40

CATERPILLAR®





## REPLACEMENT KITS FOR CATERPILLAR® EQUIPMENT

Crawler Dozers							
APPLICATION	CYL #	Misc-Parts, Instructions, etc.	CODE	ROD	BORE	KIT #	List \$
<b>MODEL D7F</b>							
LIFT RH							
	7J3333		P-UB-10	2-1/2	4-3/4	CTC-7X2773	178.40
RIPPER							
	3J6439		P-UB-10	2-1/2	6	CTC-7X2679	138.16
RIPPER LIFT							
	3R6724		P-UB-10	2-1/2	6	CTC-7X2679	138.16
	4T9290		P-UB-10	2-1/2	6	CTC-7X2655	113.60
TILT							
	5J7929		P-UB-10	2-1/2	6	CTC-7X2692	164.27
	6J9752		P-UB-10	3	6-1/2	CTC-1126550	177.23
	9J8748		P-UB-10	3	6-1/2	CTC-1126550	177.23
TRACK ADJUSTER							
			TRK ADJ			CTC-FIG3401	55.84
<b>MODEL D7G</b>							
DOZER LH							
	1041944		P-UB-10	2-1/2	4-3/4	CTC-1700221	141.65
	1U2133		P-UB-10	2-1/2	4-3/4	CTC-7X2773	178.40
	1U2136		P-UB-10	2-1/2	4-3/4	CTC-7X2773	178.40
DOZER LIFT							
	3R6781		P-UB-10	2-1/2	4-3/4	CTC-7X2660	179.61
DOZER LIFT LH							
	1U2133		P-UB-10	2-1/2	4-3/4	CTC-7X2660	179.61
	1U2136		P-UB-10	2-1/2	4-3/4	CTC-7X2660	179.61
DOZER LIFT RH							
	1U2134		P-UB-10	2-1/2	4-3/4	CTC-7X2660	179.61
	1U2135		P-UB-10	2-1/2	4-3/4	CTC-7X2660	179.61
DOZER RH							
	1041943		P-UB-10	2-1/2	4-3/4	CTC-1700221	141.65
	1U2134		P-UB-10	2-1/2	4-3/4	CTC-7X2773	178.40
	1U2135		P-UB-10	2-1/2	4-3/4	CTC-7X2773	178.40
DOZER TILT							
	2J6783		P-U-10	3-1/2	8-1/4	CTC-7X2720	180.67
	3J9694		P-U-10	3-1/2	8-1/4	CTC-7X2720	180.67
	3R6770		P-U-10	3-1/2	8-1/4	CTC-7X2720	180.67
	9J8748		P-UB-10	3	6-1/2	CTC-7X2694	158.86
LIFT							
	3J3271		P-UB-10	2-1/2	6	CTC-7X2679	138.16
	3R6781		P-UB-10	2-1/2	4-3/4	CTC-7X2660	179.61
	4J6177		P-UB-10	2-1/2	4-3/4	CTC-1014201	133.98
	4J6177		P-UB-10	2-1/2	4-3/4	CTC-7X2660	179.61
LIFT LH							
	7J3334		P-UB-10	2-1/2	4-3/4	CTC-7X2773	178.40
LIFT RH							
	7J3333		P-UB-10	2-1/2	4-3/4	CTC-7X2773	178.40
	9J4888		P-UB-10	2-1/2	4-3/4	CTC-7X2773	178.40
RIPPER							
	3J6439		P-UB-10	2-1/2	6	CTC-7X2679	138.16
RIPPER LIFT							
	4T9290		P-UB-10	2-1/2	6	CTC-7X2655	113.60
TILT							
	2J1402		P-UB-10	3	6-1/2	CTC-1318733	206.11
	5J7929		P-UB-10	2-1/2	6	CTC-7X2692	164.27
	6J9752		P-UB-10	3	6-1/2	CTC-1126550	177.23
	9J8748		P-UB-10	3	6-1/2	CTC-1126550	177.23
	9J8748		P-UB-10	3	6-1/2	CTC-8T1408	80.75

CATERPILLAR®



## REPLACEMENT KITS FOR CATERPILLAR® EQUIPMENT

Crawler Dozers							
APPLICATION	CYL #	Misc-Parts, Instructions, etc.	CODE	ROD	BORE	KIT #	List \$
<b>MODEL D7G</b>							
TILT LH							
	5J7930		P-UB-10	2-1/2	6	CTC-7X2692	164.27
	7J9364		P-UB-10	2-1/2	6	CTC-7X2669	233.76
TRACK ADJUSTER							
			TRK ADJ			CTC-FIG3401	55.84
<b>MODEL D7H</b>							
DOZER							
	1291908		P-UB-10	2-1/2	4	CTC-1353223	160.41
	1U4851		P-UB-10	2-1/2	4	CTC-1353253	157.63
	1U4852		P-UB-10	2-1/2	4	CTC-1353253	157.63
DOZER LIFT							
	1U3989		P-UB-10	2-1/2	3-3/4	CTC-7X2670	91.62
	1U4851		P-UB-10	2-1/2	4	CTC-1318748	153.96
	1U4852		P-UB-10	2-1/2	4	CTC-1318748	153.96
DOZER TILT							
	3G4533		P-UB-10	3	6-1/2	CTC-7X2694	158.86
	9T1370		P-UB-10	3	6-1/2	CTC-7X2694	158.86
LIFT							
	1294259		P-UB-10	2-1/2	4	CTC-1353223	160.41
	1U4852		P-UB-10	2-1/2	4	CTC-7X2659	156.77
	4T2098		P-UB-10	2-1/2	4-3/4	CTC-7X2673	178.40
	6E1836		P-UB-10	2-1/2	4	CTC-1353223	160.41
	6E1841		P-UB-10	2-1/2	4	CTC-1353223	160.41
RIPPER							
	4T8639		P-UB-10	2-3/4	5-1/4	CTC-1326121	209.57
	9T0142		P-UB-10	3	7-1/4	CTC-1326184	225.89
TILT							
	1124814		P-UB-10	2-3/4	6	CTC-1352167	210.58
	3G4533		P-UB-10	3	6-1/2	CTC-1126550	177.23
	6J9752		P-UB-10	3	6-1/2	CTC-1126550	177.23
	9T6113		P-UB-10	3	6-1/2	CTC-1126550	177.23
<b>MODEL D7R</b>							
DOZER							
	1291908		P-UB-10	2-1/2	4	CTC-1353223	160.41
	1U4851		P-UB-10	2-1/2	4	CTC-1318748	153.96
	1U4851		P-UB-10	2-1/2	4	CTC-1353253	157.63
	1U4852		P-UB-10	2-1/2	4	CTC-1318748	153.96
	1U4852		P-UB-10	2-1/2	4	CTC-1353253	157.63
LIFT							
	1294259		P-UB-10	2-1/2	4	CTC-1353223	160.41
	6E1836		P-UB-10	2-1/2	4	CTC-1353223	160.41
	6E1841		P-UB-10	2-1/2	4	CTC-1353223	160.41
RIPPER							
	9T0142		P-UB-10	3	7-1/4	CTC-1326184	225.89
TILT							
	1124814		P-UB-10	2-3/4	6	CTC-1352167	210.58
	3G4533		P-UB-10	3	6-1/2	CTC-1126550	177.23
	9T6113		P-UB-10	3	6-1/2	CTC-1126550	177.23
TILT LH							
	1470709		P-UB-10	3	6-1/2	CTC-1126550	177.23
TILT RH							
	1470708		P-UB-10	3	6-1/2	CTC-1126550	177.23
<b>MODEL D8</b>							
DOZER LIFT LH							
	3G8089		P-UB-10	2-3/4	5	CTC-7X2682	156.12
	8J8585		P-UB-10	2-3/4	5	CTC-7X2824	118.91



## REPLACEMENT KITS FOR CATERPILLAR® EQUIPMENT

<b>Crawler Dozers</b>							
APPLICATION	CYL #	Misc-Parts, Instructions, etc.	CODE	ROD	BORE	KIT #	List \$
<b>MODEL D8</b>							
<b>DOZER LIFT RH</b>							
	3G8090		P-UB-10	2-3/4	5	CTC-7X2682	156.12
	8J8584		P-UB-10	2-3/4	5	CTC-7X2824	118.91
<b>DOZER TILT</b>							
	2J3894		P-U-10	3-1/2	8-1/4	CTC-7X2720	180.67
<b>LIFT</b>							
	2J2470		P-UB-10	2-1/2	6	CTC-7X2679	138.16
	3J2189		P-UB-10	2-1/2	6	CTC-7X2679	138.16
	5J1243		P-UB-10	2-1/2	6	CTC-7X2679	138.16
	5J2815		P-UB-10	2-1/2	6	CTC-7X2679	138.16
<b>LIFT LH</b>							
	5J9378		P-UB-10	2-1/2	5	CTC-7X2675	124.26
	8J8585		P-UB-10	2-3/4	5	CTC-7X2824	118.91
<b>LIFT RH</b>							
	5J9708		P-UB-10	2-1/2	5	CTC-7X2675	124.26
<b>PIN PULLER</b>							
	4J5057		P-V-10	1-1/4	4	CTC-8T1480	82.72
<b>RIPPER</b>							
	6J9129		P-UB-10	3	7-1/4	CTC-7X2702	283.88
<b>RIPPER LIFT LH</b>							
	7J3222		P-UB-10	3-1/4	8-1/4	CTC-7X2715	264.94
	7J3222		P-UB-10	3-1/4	8-1/4	CTC-7X2801	244.36
<b>RIPPER LIFT RH</b>							
	7J3221		P-UB-10	3-1/4	8-1/4	CTC-7X2715	264.94
	7J3221		P-UB-10	3-1/4	8-1/4	CTC-7X2801	244.36
<b>RIPPER PIN PULLER</b>							
	7J0508		P-V-10	1-1/4	4	CTC-8T1480	82.72
	8J2071		P-UB-10	1-1/2	4	CTC-7X2738	87.47
<b>TILT</b>							
	6J2472		P-UB-10	3-1/2	8-1/4	CTC-7X2728	174.95
	7J0192		P-UB-10	3-1/2	8-1/4	CTC-7X2721	291.15
	8J8682		P-UB-10	3-1/2	8-1/4	CTC-7X2721	291.15
<b>MODEL D8H</b>							
<b>ANGLING</b>							
	3J2189		P-UB-10	2-1/2	6	CTC-7X2679	138.16
<b>DOZER</b>							
	2J3894		P-U-10	3-1/2	8-1/4	CTC-7X2720	180.67
	5J2815		P-UB-10	2-1/2	6	CTC-7X2679	138.16
<b>LIFT</b>							
	2J2470		P-UB-10	2-1/2	6	CTC-7X2679	138.16
	3J2189		P-UB-10	2-1/2	6	CTC-7X2679	138.16
	5J1243		P-UB-10	2-1/2	6	CTC-7X2679	138.16
<b>LIFT LH</b>							
	5J9378		P-UB-10	2-1/2	5	CTC-7X2675	124.26
<b>LIFT RH</b>							
	5J9708		P-UB-10	2-1/2	5	CTC-7X2675	124.26
<b>PIN PULLER</b>							
	4J5057		P-V-10	1-1/4	4	CTC-8T1480	82.72
	7J0508		P-V-10	1-1/4	4	CTC-8T1480	82.72
	8J2071		P-UB-10	1-1/2	4	CTC-7X2738	87.47
<b>RIPPER</b>							
	6J9129		P-UB-10	3	7-1/4	CTC-7X2702	283.88
	7J3222		P-UB-10	3-1/4	8-1/4	CTC-7X2715	264.94
<b>RIPPER LIFT LH</b>							
	7J3222		P-UB-10	3-1/4	8-1/4	CTC-7X2715	264.94
	7J3222		P-UB-10	3-1/4	8-1/4	CTC-7X2801	244.36

**CATERPILLAR®**



## REPLACEMENT KITS FOR CATERPILLAR® EQUIPMENT

Crawler Dozers							
APPLICATION	CYL #	Misc-Parts, Instructions, etc.	CODE	ROD	BORE	KIT #	List \$
<b>MODEL D8H</b>							
RIPPER LIFT RH							
	7J3221		P-UB-10	3-1/4	8-1/4	CTC-7X2715	264.94
RIPPER PIN PULLER							
	7J0508		P-V-10	1-1/4	4	CTC-8T1480	82.72
RIPPER RH							
	7J3221		P-UB-10	3-1/4	8-1/4	CTC-7X2801	244.36
TILT							
	6J2472		P-UB-10	3-1/2	8-1/4	CTC-7X2728	174.95
	7J0192		P-UB-10	3-1/2	8-1/4	CTC-1371974	255.18
	7J0192		P-UB-10	3-1/2	8-1/4	CTC-7X2721	291.15
TRACK ADJUSTER							
			TRK ADJ			CTC-FIG1401	114.41
<b>MODEL D8K</b>							
DOZER LIFT LH							
	3G8089		P-UB-10	2-3/4	5	CTC-7X2682	156.12
	8J8585		P-UB-10	2-3/4	5	CTC-7X2824	118.91
DOZER LIFT RH							
	3G8090		P-UB-10	2-3/4	5	CTC-7X2682	156.12
	8J8584		P-UB-10	2-3/4	5	CTC-7X2824	118.91
PIN PULLER							
	7J0508		P-V-10	1-1/4	4	CTC-8T1480	82.72
	8J2071		P-UB-10	1-1/2	4	CTC-7X2738	87.47
RIPPER							
	6J9129		P-UB-10	3	7-1/4	CTC-7X2702	283.88
	7J3222		P-UB-10	3-1/4	8-1/4	CTC-7X2715	264.94
RIPPER LIFT LH							
	7J3222		P-UB-10	3-1/4	8-1/4	CTC-7X2715	264.94
	7J3222		P-UB-10	3-1/4	8-1/4	CTC-7X2801	244.36
RIPPER LIFT RH							
	7J3221		P-UB-10	3-1/4	8-1/4	CTC-7X2715	264.94
	7J3221		P-UB-10	3-1/4	8-1/4	CTC-7X2801	244.36
RIPPER PIN PULLER							
	8J2071		P-UB-10	1-1/2	4	CTC-7X2738	87.47
TILT							
	7J0192		P-UB-10	3-1/2	8-1/4	CTC-7X2721	291.15
	8J8682		P-UB-10	3-1/2	8-1/4	CTC-1371974	255.18
<b>MODEL D8L</b>							
DOZER							
	9J8802		P-UB-10	3-1/2	7-1/2	CTC-7X2722	185.75
DOZER LIFT							
	9J8802		P-UB-10	3-1/2	7-1/2	CTC-7X2722	185.75
	9T2860		P-UB-10	3	5-1/4	CTC-7X2756	126.44
DOZER TILT							
	3G5707		P-UB-10	3-1/2	8-1/4	CTC-7X2721	291.15
LIFT							
	3G8537		P-UB-10	3	5-1/4	CTC-1378646	184.67
	3G8537		P-UB-10	3	5-1/4	CTC-7X2756	126.44
	9T2860		P-UB-10	3	5-1/4	CTC-1378646	184.67
	9T2860		P-UB-10	3	5-1/4	CTC-7X2756	126.44
PIN PULLER							
	1U3373		P-UB-10	1-1/2	4	CTC-7X2738	87.47
RIPPER							
	3G6457		P-UB-10	3-1/4	8-1/4	CTC-7X2715	264.94
RIPPER LIFT							
	3G6457		P-UB-10	3-1/4	8-1/4	CTC-7X2715	264.94
RIPPER PIN PULLER							
	1U3373		P-UB-10	1-1/2	4	CTC-7X2738	87.47



## REPLACEMENT KITS FOR CATERPILLAR® EQUIPMENT

<b>Crawler Dozers</b>							
APPLICATION	CYL #	Misc-Parts, Instructions, etc.	CODE	ROD	BORE	KIT #	List \$
<b>MODEL D8L</b>							
RIPPER TILT							
	9T0106		P-UB-10	3	6-1/2	CTC-1126552	231.80
	9T0106		P-UB-10	3	6-1/2	CTC-7X2693	180.48
TILT							
	3G5707		P-UB-10	3-1/2	8-1/4	CTC-1371974	255.18
<b>MODEL D8N</b>							
DOZER							
	6E1102		P-UB-10	3	4-1/2	CTC-1353802	174.37
	6E1175		P-UB-10	3-1/2	7-1/4	CTC-1309483	330.34
	9T0140		P-UB-10	2-3/4	4-1/4	CTC-7X2451	110.88
	9T0141		P-UB-10	3-1/2	7-1/2	CTC-7X2722	185.75
PIN PULLER							
	6E3113		P-UB-10	1-3/4	4	CTC-1316108	108.64
	9T2066		P-UB-10	1-1/2	4	CTC-7X2738	87.47
RIPPER							
	9T0142		P-UB-10	3	7-1/4	CTC-1326184	225.89
	9T0143		P-UB-10	3	6-1/2	CTC-1279809	231.47
TILT							
	6E0397		P-UB-10	3	7-1/4	CTC-1326127	207.98
	9T6077		P-UB-10	3	6-1/2	CTC-1126550	177.23
<b>MODEL D8R</b>							
DOZER							
	6E1102		P-UB-10	3	4-1/2	CTC-1353802	174.37
	6E1175		P-UB-10	3-1/2	7-1/4	CTC-1309483	330.34
PIN PULLER							
	6E3113		P-UB-10	1-3/4	4	CTC-1316108	108.64
	9T2066		P-UB-10	1-1/2	4	CTC-7X2738	87.47
RIPPER							
	4Z6313		P-UB-10	3	6-1/2	CTC-1279809	231.47
	9T0142		P-UB-10	3	7-1/4	CTC-1326184	225.89
	9T0143		P-UB-10	3	6-1/2	CTC-1279809	231.47
TILT							
	6E0397		P-UB-10	3	7-1/4	CTC-1326127	207.98
<b>MODEL D8T</b>							
DOZER LIFT							
	J8B1-UP; KPZ1-UP						
	2505861		P-UB-10	3	4-1/2	CTC-2505861K	95.62
DOZER TILT							
	J8B1-UP; KPZ1-UP						
	2407347		P-UB-10	3-1/2	7-1/4	CTC-2407347K	185.41
	2410550		P-UB-10	3-1/2	7-1/4	CTC-2410550K	131.37
	6E0397		P-UB-10	3	7-1/4	CTC-6E0397K	133.19
RIPPER							
	J8B1-UP; KPZ1-UP						
	1553653		P-UB-10	3	7-1/4	CTC-1553653K	180.17
RIPPER PIN PULLER							
	J8B1-UP; KPZ1-UP						
	6E3113		P-UB-10	1-3/4	4	CTC-6E3113K	45.90
RIPPER-LH							
	J8B1-UP; KPZ1-UP						
	1553652		P-UB-10	3	6-1/2	CTC-1553652K	150.56
RIPPER-RH							
	J8B1-UP; KPZ1-UP						
	1650102		P-UB-10	3	6-1/2	CTC-1650102K	163.22
TILT							
	KPZ3627-UP						
	3473272		P-UB-10	3-1/2	7-1/4	CTC-3473272K	155.73

**CATERPILLAR®**



## REPLACEMENT KITS FOR CATERPILLAR® EQUIPMENT

<b>Crawler Dozers</b>							
APPLICATION	CYL #	Misc-Parts, Instructions, etc.	CODE	ROD	BORE	KIT #	List \$
<b>MODEL D9D</b>							
TRACK ADJUSTER							
			TRK ADJ			CTC-FIG0401	103.67
<b>MODEL D9G</b>							
DOZER TILT							
	2J6705		P-U-10	3-1/2	8-1/4	CTC-7X2720	180.67
LIFT LH							
	7J1488		P-UB-10	3-1/4	9-1/4	CTC-7X2707	346.13
LIFT RH							
	7J1487		P-UB-10	3-1/4	9-1/4	CTC-7X2707	346.13
PIN PULLER							
	4J5057		P-V-10	1-1/4	4	CTC-8T1480	82.72
	7J0508		P-V-10	1-1/4	4	CTC-8T1480	82.72
	8J2071		P-UB-10	1-1/2	4	CTC-7X2738	87.47
RIPPER							
	6J7810		P-UB-10	3-1/2	8-1/4	CTC-7X2725	389.08
RIPPER LIFT LH							
	7J1488		P-UB-10	3-1/4	9-1/4	CTC-7X2707	346.13
RIPPER LIFT RH							
	7J1487		P-UB-10	3-1/4	9-1/4	CTC-7X2707	346.13
RIPPER PIN PULLER							
	8J2071		P-UB-10	1-1/2	4	CTC-7X2738	87.47
RIPPER TILT							
	6J7810		P-UB-10	3-1/2	8-1/4	CTC-7X2725	389.08
TILT							
	6J1570		P-UB-10	3-1/2	8-1/4	CTC-1371974	255.18
	6J1570		P-UB-10	3-1/2	8-1/4	CTC-7X2721	291.15
TRACK ADJUSTER							
			TRK ADJ			CTC-FIG0401	103.67
			TRK ADJ			CTC-FIG0402	122.15
<b>MODEL D9H</b>							
DOZER LH							
	3G1174		P-UB-10	3	6-1/4	CTC-7X2697	158.18
	3G1177		P-UB-10	3	6-1/4	CTC-7X2697	158.18
DOZER RH							
	3G1175		P-UB-10	3	6-1/4	CTC-7X2697	158.18
	3G1176		P-UB-10	3	6-1/4	CTC-7X2697	158.18
LIFT LH							
	3G1174		P-UB-10	3	6-1/4	CTC-7X2697	158.18
	3G1177		P-UB-10	3	6-1/4	CTC-7X2697	158.18
	7J1488		P-UB-10	3-1/4	9-1/4	CTC-1895377	241.10
	7J1488		P-UB-10	3-1/4	9-1/4	CTC-7X2707	346.13
LIFT RH							
	3G1175		P-UB-10	3	6-1/4	CTC-7X2697	158.18
	3G1176		P-UB-10	3	6-1/4	CTC-7X2697	158.18
	7J1487		P-UB-10	3-1/4	9-1/4	CTC-1895377	241.10
	7J1487		P-UB-10	3-1/4	9-1/4	CTC-7X2707	346.13
PIN PULLER							
	8J2071		P-UB-10	1-1/2	4	CTC-7X2738	87.47
RIPPER							
	6J7810		P-UB-10	3-1/2	8-1/4	CTC-7X2725	389.08
RIPPER LIFT LH							
	7J1488		P-UB-10	3-1/4	9-1/4	CTC-7X2707	346.13
RIPPER LIFT RH							
	7J1487		P-UB-10	3-1/4	9-1/4	CTC-7X2707	346.13
RIPPER PIN PULLER							
	8J2071		P-UB-10	1-1/2	4	CTC-7X2738	87.47

CATERPILLAR®



## REPLACEMENT KITS FOR CATERPILLAR® EQUIPMENT

<b>Crawler Dozers</b>							
APPLICATION	CYL #	Misc-Parts, Instructions, etc.	CODE	ROD	BORE	KIT #	List \$
<b>MODEL D9H</b>							
RIPPER TILT							
	6J7810		P-UB-10	3-1/2	8-1/4	CTC-7X2725	389.08
TILT							
	6J1570		P-UB-10	3-1/2	8-1/4	CTC-1371974	255.18
	6J1570		P-UB-10	3-1/2	8-1/4	CTC-7X2721	291.15
<b>MODEL D9L</b>							
DOZER TILT							
	3G8661		P-UB-10	4	9-1/4	CTC-7X2799	357.79
	4T4248		P-UB-10	4	9-1/4	CTC-7X2799	357.79
LIFT							
	9J5868		P-UB-10	3-1/4	6	CTC-7X2757	267.61
PIN PULLER							
	1U3373		P-UB-10	1-1/2	4	CTC-7X2738	87.47
RIPPER LIFT							
	4T0979		P-UB-10	3-1/4	9-1/4	CTC-7X2707	346.13
RIPPER LIFT LH							
	4T5111		P-UB-10	3-1/4	9-1/4	CTC-7X2707	346.13
RIPPER LIFT RH							
	4T5112		P-UB-10	3-1/4	9-1/4	CTC-7X2707	346.13
RIPPER PIN PULLER							
	1U3373		P-UB-10	1-1/2	4	CTC-7X2738	87.47
RIPPER TILT							
	4T6970		P-UB-10	3-1/4	8-1/4	CTC-7X2715	264.94
	4T9977		P-UB-10	3-1/4	8-1/4	CTC-7X2715	264.94
<b>MODEL D9N</b>							
DOZER LIFT							
	9T2860		P-UB-10	3	5-1/4	CTC-7X2756	126.44
DOZER TILT							
	3G5707		P-UB-10	3-1/2	8-1/4	CTC-7X2721	291.15
LIFT							
	9T2860		P-UB-10	3	5-1/4	CTC-7X2756	126.44
PIN PULLER							
	6E3113		P-UB-10	1-3/4	4	CTC-1316108	108.64
	9T2066		P-UB-10	1-1/2	4	CTC-7X2738	87.47
RIPPER							
	3G6457		P-UB-10	3-1/4	8-1/4	CTC-7X2715	264.94
RIPPER LIFT							
	3G6457		P-UB-10	3-1/4	8-1/4	CTC-7X2715	264.94
RIPPER PIN PULLER							
	9T2066		P-UB-10	1-1/2	4	CTC-7X2738	87.47
TILT							
	3G5707		P-UB-10	3-1/2	8-1/4	CTC-1371974	255.18
	6E4835	1229350 Piston	P-UB-10	3-1/2	8-1/4	CTC-1324905	209.96
	6E4836	1229350 Piston	P-UB-10	3-1/2	8-1/4	CTC-1324905	209.96
<b>MODEL D9R</b>							
DOZER							
	4Z6172		P-UB-10	3	4-3/4	CTC-1362025	209.10
	6E4433		P-UB-10	3	4-3/4	CTC-1542503	125.15
PIN PULLER							
	6E3113		P-UB-10	1-3/4	4	CTC-1316108	108.64
RIPPER							
	1238098		P-UB-10	3-1/4	7-1/4	CTC-1324987	243.58
	1325123		P-UB-10	3-1/4	7-1/4	CTC-1324987	243.58
	9T5813		P-UB-10	3-1/4	7-1/4	CTC-1324987	243.58

**CATERPILLAR®**





## REPLACEMENT KITS FOR CATERPILLAR® EQUIPMENT

Crawler Dozers							
APPLICATION	CYL #	Misc-Parts, Instructions, etc.	CODE	ROD	BORE	KIT #	List \$
<b>MODEL D9R</b>							
RIPPER TILT							
	1238097		P-UB-10	3	6	CTC-1324937	133.88
	1325149		P-UB-10	3	6	CTC-1324937	133.88
	9T5807		P-UB-10	3	6	CTC-1324937	133.88
TILT							
	1096778		P-UB-10	3-1/2	8-1/4	CTC-1324905	209.96
TILT LH							
	1098833		P-UB-10	3-1/2	8-1/4	CTC-1324905	209.96
	6E4835		P-UB-10	3-1/2	8-1/4	CTC-7X2721	291.15
TILT RH							
	1098832		P-UB-10	3-1/2	8-1/4	CTC-1324905	209.96
	6E4836		P-UB-10	3-1/2	8-1/4	CTC-7X2721	291.15
<b>MODEL D9T</b>							
DOZER LIFT							
	RJS1-UP						
	2256727		P-UB-10	3	4-3/4	CTC-2256727K	131.20
	RJS1-UP; T9H1-UP; T9J1-UP						
	1658633		P-UB-10	3	4-3/4	CTC-1658633K	129.58
DOZER TILT							
	T9J1-UP						
	4Z6110		P-UB-10	3-1/2	8-1/4	CTC-4Z6110K	175.35
DOZER TILT LH							
	RJS1-UP						
	1098833		P-UB-10	3-1/2	8-1/4	CTC-2456835	184.00
DOZER TILT RH							
	RJS1-UP						
	1098832		P-UB-10	3-1/2	8-1/4	CTC-2456835	184.00
DOZER TILT STABILIZER							
	T9H1-UP; T9J1-UP						
	1096778		P-UB-10	3-1/2	8-1/4	CTC-2456835	184.00
RIPPER							
	CRM1-UP						
	1325123		P-UB-10	3-1/4	7-1/4	CTC-1325123K	166.64
RIPPER - PIN PULLER							
	RJS1-UP						
	6E3113		P-UB-10	1-3/4	4	CTC-2404819	108.64
RIPPER TIP							
	CRM1-UP; MAM1-UP						
	1325149		P-UB-10	3	6	CTC-1325149K	144.69
	RJS1-UP						
	4Z6364	Cold Weather	P-UB-10	3	6	CTC-4Z6364K	125.13
<b>MODEL D10</b>							
DOZER							
	1U2711		P-UB-10	4	10-1/2	CTC-1324932	361.38
	3G5761		P-UB-10	4	10-1/2	CTC-1324932	361.38
DOZER LH							
	4T3211		P-UB-10	4	10-1/2	CTC-1324932	361.38
DOZER LIFT LH							
	4T2727		P-UB-10	4	7	CTC-8T1457	192.08
	9J2959		P-UB-10	4	7	CTC-1326783	259.77
DOZER LIFT RH							
	4T2728		P-UB-10	4	7	CTC-8T1457	192.08
	9J2958		P-UB-10	4	7	CTC-1326783	259.77
DOZER RH							
	4T3210		P-UB-10	4	10-1/2	CTC-1324932	361.38

CATERPILLAR®



## REPLACEMENT KITS FOR CATERPILLAR® EQUIPMENT

<b>Crawler Dozers</b>							
APPLICATION	CYL #	Misc-Parts, Instructions, etc.	CODE	ROD	BORE	KIT #	List \$
<b>MODEL D10</b>							
PIN PULLER							
	1U3373		P-UB-10	1-1/2	4	CTC-7X2738	87.47
	8J2071		P-UB-10	1-1/2	4	CTC-7X2738	87.47
RIPPER							
	3G2220		P-UB-10	3-1/4	8-1/4	CTC-7X2801	244.36
RIPPER PIN PULLER							
	1U3373		P-UB-10	1-1/2	4	CTC-7X2738	87.47
	8J2071		P-UB-10	1-1/2	4	CTC-7X2738	87.47
RIPPER TILT							
	3G2220		P-UB-10	3-1/4	8-1/4	CTC-7X2801	244.36
<b>MODEL D10N</b>							
DOZER							
	9T4279		P-UB-10	4	9-1/4	CTC-1324922	319.24
	9T4280		P-UB-10	4	9-1/4	CTC-1324922	319.24
	9T7341		P-UB-10	4	9-1/4	CTC-1324922	319.24
DOZER LIFT							
	9T2869		P-UB-10	3-1/2	6-1/4	CTC-7X0863	169.04
DOZER TILT							
	9T1180		P-UB-10	4	9-1/4	CTC-7X2799	357.79
	9T4279		P-UB-10	4	9-1/4	CTC-7X2799	357.79
LIFT							
	9T2869		P-UB-10	3-1/2	6-1/4	CTC-1365158	206.84
PIN PULLER							
	6E3113		P-UB-10	1-3/4	4	CTC-1316108	108.64
	9T2066		P-UB-10	1-1/2	4	CTC-7X2738	87.47
RIPPER							
	4T9977		P-UB-10	3-1/4	8-1/4	CTC-7X2715	264.94
RIPPER LH							
	4T5111		P-UB-10	3-1/4	9-1/4	CTC-1469631	243.91
	4T5111		P-UB-10	3-1/4	9-1/4	CTC-7X2707	346.13
RIPPER LIFT LH							
	4T5111		P-UB-10	3-1/4	9-1/4	CTC-7X2707	346.13
RIPPER LIFT RH							
	4T5112		P-UB-10	3-1/4	9-1/4	CTC-7X2707	346.13
RIPPER PIN PULLER							
	9T2066		P-UB-10	1-1/2	4	CTC-7X2738	87.47
RIPPER RH							
	4T5112		P-UB-10	3-1/4	9-1/4	CTC-1469631	243.91
	4T5112		P-UB-10	3-1/4	9-1/4	CTC-7X2707	346.13
RIPPER TILT							
	4T9977		P-UB-10	3-1/4	8-1/4	CTC-7X2715	264.94
TILT LH							
	9J0673		P-UB-10	2-3/4	6	CTC-7X2803	171.39
TILT RH							
	9T9203		P-UB-10	4	9-1/4	CTC-1324922	319.24
TWIN TILT LH							
	9T9204		P-UB-10	4	9-1/4	CTC-7X2799	357.79
TWIN TILT RH							
	9T9203		P-UB-10	4	9-1/4	CTC-7X2799	357.79
<b>MODEL D10R</b>							
DOZER LH							
	9T9204		P-UB-10	4	9-1/4	CTC-1324922	319.24
DOZER RH							
	4T5112		P-UB-10	3-1/4	9-1/4	CTC-1469631	243.91
LIFT							
	9T2869		P-UB-10	3-1/2	6-1/4	CTC-1365158	206.84

**CATERPILLAR®**



## REPLACEMENT KITS FOR CATERPILLAR® EQUIPMENT

Crawler Dozers							
APPLICATION	CYL #	Misc-Parts, Instructions, etc.	CODE	ROD	BORE	KIT #	List \$
<b>MODEL D10R</b>							
PIN PULLER							
	6E3113		P-UB-10	1-3/4	4	CTC-1316108	108.64
RIPPER							
	4T9977		P-UB-10	3-1/4	8-1/4	CTC-7X2715	264.94
RIPPER LH							
	4T5111		P-UB-10	3-1/4	9-1/4	CTC-1469631	243.91
	4T5111		P-UB-10	3-1/4	9-1/4	CTC-7X2707	346.13
RIPPER RH							
	4T5112		P-UB-10	3-1/4	9-1/4	CTC-7X2707	346.13
TILT							
	9T9202		P-UB-10	4	9-1/4	CTC-1324922	319.24
<b>MODEL D10T</b>							
DOZER LIFT							
	BHA1-UP; BHF1-UP; BHJ1-UP; BHP1-UP; RJG1-UP						
	9T2869		P-UB-10	3-1/2	6-1/4	CTC-9T2869K	203.66
DOZER LIFT RH							
	RJG1-1900						
	2310865		P-UB-10	3-1/2	6-1/4	CTC-3189220	391.40
	RJG1901-UP						
	3238514		P-UB-10	3-1/2	6-1/4	CTC-3189220	391.40
DOZER TILT							
	BHA1-UP; BHF1-UP; BHJ1-UP; BHP1-UP						
	2320654		P-UB-10	4	9-1/4	CTC-2320654K	288.72
DUAL TILT LH							
	RJG1-UP						
	2320652		P-UB-10	4	9-1/4	CTC-2320652K	279.06
DUAL TILT RH							
	RJG1-UP						
	2320653		P-UB-10	4	9-1/4	CTC-2320653K	279.06
RIPPER - PIN PULLER							
	RJG1-UP						
	6E3113		P-UB-10	1-3/4	4	CTC-2404819	108.64
RIPPER LIFT LH							
	4PP1-UP; BRT1-UP; BEY1-UP						
	1926446		P-UB-10	3-1/2	9-1/4	CTC-1926446K	264.37
RIPPER LIFT RH							
	4PP1-UP; BRT1-UP; BEY1-UP						
	1926445		P-UB-10	3-1/2	9-1/4	CTC-1926445K	264.37
RIPPER TILT							
	4PP1-UP; BRT1-UP; BEY1-UP						
	4T9977		P-UB-10	3-1/4	8-1/4	CTC-4T9977K	155.76
<b>MODEL D11N</b>							
DOZER LIFT LH							
	4T2727		P-UB-10	4	7	CTC-1326783	259.77
	4T2727		P-UB-10	4	7	CTC-8T1457	192.08
DOZER LIFT RH							
	4T2728		P-UB-10	4	7	CTC-1326783	259.77
	4T2728		P-UB-10	4	7	CTC-8T1457	192.08
DOZER TILT							
	1U2711		P-UB-10	4	10-1/2	CTC-1324932	361.38
	9T1180		P-UB-10	4	9-1/4	CTC-7X2799	357.79
	9T4276		P-UB-10	4	9-1/4	CTC-7X2799	357.79
PIN PULLER							
	6E3113		P-UB-10	1-3/4	4	CTC-2404819	108.64
	9T2066		P-UB-10	1-1/2	4	CTC-7X2738	87.47
RIPPER							
	4T7985		P-UB-10	3-1/4	8-1/4	CTC-7X2715	264.94



## REPLACEMENT KITS FOR CATERPILLAR® EQUIPMENT

<b>Crawler Dozers</b>							
APPLICATION	CYL #	Misc-Parts, Instructions, etc.	CODE	ROD	BORE	KIT #	List \$
<b>MODEL D11N</b>							
<b>RIPPER PIN PULLER</b>							
	9T2066		P-UB-10	1-1/2	4	CTC-7X2738	87.47
<b>RIPPER TILT</b>							
	3G2220		P-UB-10	3-1/4	8-1/4	CTC-7X2801	244.36
	3G3220		P-UB-10	3-1/4	8-1/4	CTC-7X2715	264.94
	4T7985		P-UB-10	3-1/4	8-1/4	CTC-7X2715	264.94
<b>TILT</b>							
	9T3715		P-UB-10	4	10-1/2	CTC-1324932	361.38
	9T3716		P-UB-10	4	10-1/2	CTC-1324932	361.38
<b>MODEL D11R</b>							
<b>DOZER</b>							
	1U2711		P-UB-10	4	10-1/2	CTC-1324932	361.38
<b>DOZER LH</b>							
	4T2727		P-UB-10	4	7	CTC-1326783	259.77
	4T2727		P-UB-10	4	7	CTC-8T1457	192.08
<b>DOZER RH</b>							
	4T2728		P-UB-10	4	7	CTC-1326783	259.77
	4T2728		P-UB-10	4	7	CTC-8T1457	192.08
<b>PIN PULLER</b>							
	6E3113		P-UB-10	1-3/4	4	CTC-1316108	108.64
	9T2066		P-UB-10	1-1/2	4	CTC-7X2738	87.47
<b>TILT</b>							
	9T3715		P-UB-10	4	10-1/2	CTC-1324932	361.38
	9T3716		P-UB-10	4	10-1/2	CTC-1324932	361.38
<b>Crawler Loaders</b>							
APPLICATION	CYL #	Misc-Parts, Instructions, etc.	CODE	ROD	BORE	KIT #	List \$
<b>MODEL 931</b>							
<b>BACKHOE BOOM</b>							
	3G5767		P-UB-10	2-1/4	4-1/2	CTC-7X2748	107.59
	8J5555		P-UB-10	2-1/4	4-1/2	CTC-7X2748	107.59
<b>BACKHOE BUCKET</b>							
	3G5905		P-UB-10	2-1/4	3-1/2	CTC-7X2818	90.21
	8J5642		P-UB-10	2-1/4	3-1/2	CTC-7X2818	90.21
<b>BACKHOE STABILIZER</b>							
	1U2655		P-UB-10	2	4	CTC-1328816	92.75
	1U2656		P-UB-10	2	4	CTC-1328816	92.75
	3G6792		P-UB-10	1-1/2	3-1/2	CTC-7X2752	95.40
	8J6903		P-UB-10	2	4	CTC-1328816	92.75
	8J6904		P-UB-10	2	4	CTC-1328816	92.75
	8J9481		P-UB-10	1-1/2	3-1/2	CTC-7X2752	95.40
<b>BACKHOE STICK</b>							
	3G5771		P-UB-10	2	4	CTC-1328816	92.75
	8J5448		P-UB-10	2	4	CTC-1328816	92.75
<b>LIFT</b>							
	7J5893		P-UB-10	2	4	CTC-1328816	92.75
	7J5894		P-UB-10	2	4	CTC-1328816	92.75
<b>M.P. BUCKET</b>							
	3G7365		P-UB-10	1-1/2	3-1/2	CTC-7X2752	95.40
	8J5391		P-UB-10	1-1/2	3-1/2	CTC-7X2752	95.40
<b>RIPPER</b>							
	7J9920		P-UB-10	2	4	CTC-1328816	92.75
<b>TILT</b>							
	7J5885		P-UB-10	1-3/4	3	CTC-7X2791	88.60
	9J7905		P-UB-10	1-3/4	3	CTC-7X2791	88.60

**CATERPILLAR®**



## REPLACEMENT KITS FOR CATERPILLAR® EQUIPMENT

<b>Crawler Loaders</b>							
APPLICATION	CYL #	Misc-Parts, Instructions, etc.	CODE	ROD	BORE	KIT #	List \$
<b>MODEL 931B</b>							
<b>BACKHOE BOOM/BUCKET</b>							
	3G5767		P-UB-10	2-1/4	4-1/2	CTC-1326770	150.17
	3G5905		P-UB-10	2-1/4	3-1/2	CTC-1358166	171.50
<b>BACKHOE BUCKET</b>							
	8J5642		P-UB-10	2-1/4	3-1/2	CTC-7X2818	90.21
<b>BACKHOE STABILIZER</b>							
	8J6903		P-UB-10	2	4	CTC-7X2789	102.01
	8J6904		P-UB-10	2	4	CTC-7X2789	102.01
	8J9481		P-UB-10	1-1/2	3-1/2	CTC-7X2752	95.40
<b>BACKHOE STICK/BLADE SHIFT</b>							
	3G5771		P-UB-10	2	4	CTC-1328816	92.75
<b>LIFT</b>							
	7J5893		P-UB-10	2	4	CTC-1328816	92.75
	7J5894		P-UB-10	2	4	CTC-1328816	92.75
<b>LIFT LH</b>							
	6E0214		P-UB-10	2	4	CTC-1328816	92.75
	9T6705		P-UB-10	2	4	CTC-1328816	92.75
<b>LIFT RH</b>							
	9T6704		P-UB-10	2	4	CTC-1328816	92.75
<b>M.P. BUCKET</b>							
	3G7365		P-UB-10	1-1/2	3-1/2	CTC-7X2752	95.40
<b>RIPPER</b>							
	7J9920		P-UB-10	2	4	CTC-1328816	92.75
<b>STABILIZER</b>							
	3G6792		P-UB-10	1-1/2	3-1/2	CTC-7X2752	95.40
	8J6903		P-UB-10	2	4	CTC-7X2789	102.01
	8J6904		P-UB-10	2	4	CTC-7X2789	102.01
	8J9481		P-UB-10	1-1/2	3-1/2	CTC-7X2752	95.40
<b>STABILIZER LH</b>							
	1U2656		P-UB-10	2	4	CTC-1328816	92.75
<b>STABILIZER RH</b>							
	1U2655		P-UB-10	2	4	CTC-1328816	92.75
<b>TILT</b>							
	1U3165		P-UB-10	1-3/4	3-1/4	CTC-7X2764	68.76
	4T0963		P-UB-10	1-3/4	3-1/4	CTC-7X2764	68.76
	7J5885		P-UB-10	1-3/4	3	CTC-7X2791	88.60
	9J7905		P-UB-10	1-3/4	3	CTC-7X2791	88.60
<b>MODEL 931C</b>							
<b>BACKHOE BOOM/BUCKET</b>							
	3G5767		P-UB-10	2-1/4	4-1/2	CTC-1326770	150.17
	3G5767		P-UB-10	2-1/4	4-1/2	CTC-7X2748	107.59
	3G5905		P-UB-10	2-1/4	3-1/2	CTC-1358166	171.50
<b>BACKHOE BUCKET</b>							
	8J5642		P-UB-10	2-1/4	3-1/2	CTC-7X2818	90.21
<b>BACKHOE STABILIZER</b>							
	1U2655		P-UB-10	2	4	CTC-7X2789	102.01
	1U2656		P-UB-10	2	4	CTC-7X2789	102.01
	3G6792		P-UB-10	1-1/2	3-1/2	CTC-7X2752	95.40
	8J6903		P-UB-10	2	4	CTC-7X2789	102.01
	8J6904		P-UB-10	2	4	CTC-7X2789	102.01
	8J9481		P-UB-10	1-1/2	3-1/2	CTC-7X2752	95.40
<b>BACKHOE STICK/BLADE SHIFT</b>							
	3G5771		P-UB-10	2	4	CTC-1328816	92.75
<b>BUCKET</b>							
	3G7365		P-UB-10	1-1/2	3-1/2	CTC-7X2752	95.40

**CATERPILLAR®**



## REPLACEMENT KITS FOR CATERPILLAR® EQUIPMENT

<b>Crawler Loaders</b>							
APPLICATION	CYL #	Misc-Parts, Instructions, etc.	CODE	ROD	BORE	KIT #	List \$
<b>MODEL 931C</b>							
LIFT							
	7J5893		P-UB-10	2	4	CTC-1328816	92.75
	7J5894		P-UB-10	2	4	CTC-1328816	92.75
LIFT LH							
	6E0214		P-UB-10	2	4	CTC-1328816	92.75
	9T6705		P-UB-10	2	4	CTC-1328816	92.75
LIFT RH							
	9T6704		P-UB-10	2	4	CTC-1328816	92.75
M.P. BUCKET							
	3G7365		P-UB-10	1-1/2	3-1/2	CTC-7X2752	95.40
RIPPER							
	7J9920		P-UB-10	2	4	CTC-1328816	92.75
STABILIZER							
	3G6792		P-UB-10	1-1/2	3-1/2	CTC-7X2752	95.40
STABILIZER LH							
	1U2656		P-UB-10	2	4	CTC-1328816	92.75
STABILIZER RH							
	1U2655		P-UB-10	2	4	CTC-1328816	92.75
TILT							
	4T0963		P-UB-10	1-3/4	3-1/4	CTC-7X2764	68.76
<b>MODEL 933</b>							
BUCKET							
	3G7365		P-UB-10	1-1/2	3-1/2	CTC-7X2752	95.40
LIFT LH							
	1052808		P-UB-10	2	4	CTC-1328816	92.75
LIFT RH							
	1052886		P-UB-10	2	4	CTC-1328816	92.75
	6E0212		P-UB-10	2	4	CTC-1328816	92.75
RIPPER							
	7J9920		P-UB-10	2	4	CTC-1328816	92.75
TILT							
	1012493		P-UB-10	1-3/4	3-1/2	CTC-7X2784	56.35
	1368600		P-UB-10	1-3/4	3-1/2	CTC-7X2784	56.35
<b>MODEL 933C</b>							
BUCKET							
	1494362		P-UB-10	2	4	CTC-1328816	92.75
LIFT RH							
	1412421		P-UB-10	2	4	CTC-1328816	92.75
RIPPER							
	7J9920		P-UB-10	2	4	CTC-1328816	92.75
TILT							
	1214264		P-UB-10	1-3/4	3-1/2	CTC-7X2784	56.35
TRACK ADJUSTER							
			TRK ADJ			CTC-FIG4400	48.04
<b>MODEL 933E, 933F, 933G</b>							
TRACK ADJUSTER							
			TRK ADJ			CTC-FIG4400	48.04
<b>MODEL 935B</b>							
BACKHOE / BOOM BUCKET							
	3G5767		P-UB-10	2-1/4	4-1/2	CTC-1326770	150.17
	3G5905		P-UB-10	2-1/4	3-1/2	CTC-1358166	171.50
BACKHOE BUCKET							
	3G7365		P-UB-10	1-1/2	3-1/2	CTC-7X2752	95.40
BACKHOE STICK/BLADE SHIFT							
	3G5771		P-UB-10	2	4	CTC-1328816	92.75

**CATERPILLAR®**



## REPLACEMENT KITS FOR CATERPILLAR® EQUIPMENT

<b>Crawler Loaders</b>							
APPLICATION	CYL #	Misc-Parts, Instructions, etc.	CODE	ROD	BORE	KIT #	List \$
<b>MODEL 935B</b>							
LIFT							
	7J5893		P-UB-10	2	4	CTC-1328816	92.75
	7J5894		P-UB-10	2	4	CTC-1328816	92.75
LIFT LH							
	6E0214		P-UB-10	2	4	CTC-1328816	92.75
	9T6705		P-UB-10	2	4	CTC-1328816	92.75
LIFT RH							
	9T6704		P-UB-10	2	4	CTC-1328816	92.75
RIPPER							
	7J9920		P-UB-10	2	4	CTC-1328816	92.75
STABILIZER							
	3G6792		P-UB-10	1-1/2	3-1/2	CTC-7X2752	95.40
STABILIZER LH							
	1U2656		P-UB-10	2	4	CTC-1328816	92.75
STABILIZER RH							
	1U2655		P-UB-10	2	4	CTC-1328816	92.75
TILT							
	4T0963		P-UB-10	1-3/4	3-1/4	CTC-7X2764	68.76
<b>MODEL 935C</b>							
BACKHOE BOOM/BUCKET							
	3G5767		P-UB-10	2-1/4	4-1/2	CTC-1326770	150.17
	3G5905		P-UB-10	2-1/4	3-1/2	CTC-1358166	171.50
BACKHOE BUCKET							
	3G7365		P-UB-10	1-1/2	3-1/2	CTC-7X2752	95.40
BACKHOE STICK/BLADE SHIFT							
	3G5771		P-UB-10	2	4	CTC-1328816	92.75
LIFT							
	7J5893		P-UB-10	2	4	CTC-1328816	92.75
	7J5894		P-UB-10	2	4	CTC-1328816	92.75
LIFT LH							
	6E0214		P-UB-10	2	4	CTC-1328816	92.75
	9T6705		P-UB-10	2	4	CTC-1328816	92.75
LIFT RH							
	6E0212		P-UB-10	2	4	CTC-1328816	92.75
	9T6704		P-UB-10	2	4	CTC-1328816	92.75
RIPPER							
	7J9920		P-UB-10	2	4	CTC-1328816	92.75
STABILIZER							
	3G6792		P-UB-10	1-1/2	3-1/2	CTC-7X2752	95.40
STABILIZER LH							
	1U2656		P-UB-10	2	4	CTC-1328816	92.75
STABILIZER RH							
	1U2655		P-UB-10	2	4	CTC-1328816	92.75
TILT							
	4T0963		P-UB-10	1-3/4	3-1/4	CTC-7X2764	68.76
<b>MODEL 939</b>							
BUCKET							
	3G7365		P-UB-10	1-1/2	3-1/2	CTC-7X2752	95.40
LIFT LH							
	1052808		P-UB-10	2	4	CTC-1328816	92.75
LIFT RH							
	1052886		P-UB-10	2	4	CTC-1328816	92.75
	6E0212		P-UB-10	2	4	CTC-1328816	92.75
RIPPER							
	7J9920		P-UB-10	2	4	CTC-1328816	92.75

CATERPILLAR®





## REPLACEMENT KITS FOR CATERPILLAR® EQUIPMENT

<b>Crawler Loaders</b>							
APPLICATION	CYL #	Misc-Parts, Instructions, etc.	CODE	ROD	BORE	KIT #	List \$
<b>MODEL 939</b>							
TILT							
	1012518		P-UB-10	2	4	CTC-1328816	92.75
	1363129		P-UB-10	2	4	CTC-1328816	92.75
<b>MODEL 939C</b>							
BUCKET							
	1494362		P-UB-10	2	4	CTC-1328816	92.75
LIFT							
	1412422		P-UB-10	2-1/2	4-1/2	CTC-1113300	136.57
RIPPER							
	7J9920		P-UB-10	2	4	CTC-1328816	92.75
TILT							
	1414266		P-UB-10	2	4	CTC-1328816	92.75
<b>MODEL 941</b>							
BUCKET							
	7J6789		P-UB-10	2	4	CTC-7X2789	102.01
	8J5663		P-UB-10	2	4	CTC-7X2789	102.01
BUCKET LH							
	6J2806		P-UB-10	2	4	CTC-7X2789	102.01
BUCKET RH							
	6J2805		P-UB-10	2	4	CTC-7X2789	102.01
LIFT							
	8J6868		P-UB-10	2-1/2	4	CTC-7X2659	156.77
LIFT LH							
	6J3082		P-UB-10	2-1/4	4	CTC-7X2802	91.69
	7J9862		P-UB-10	2-1/4	4	CTC-7X2802	91.69
	9J5726		P-UB-10	2-1/4	4	CTC-7X2802	91.69
LIFT RH							
	6J3081		P-UB-10	2-1/4	4	CTC-7X2802	91.69
	7J9861		P-UB-10	2-1/4	4	CTC-7X2802	91.69
	9J5725		P-UB-10	2-1/4	4	CTC-7X2802	91.69
RIPPER							
	6J3308		P-UB-10	2-1/2	5-1/2	CTC-8T1374	93.39
	6J3308		P-UB-10	2-1/2	5-1/2	CTC-9X2050	100.69
SIDE DUMP							
	8J5670		P-UB-10	2	4	CTC-7X2755	147.15
	8J5670		P-UB-10	2	4	CTC-7X7937	160.47
TILT							
			P-UB-10	2-3/8	4	CTC-2418925	56.47
TRACK ADJUSTER							
			TRK ADJ			CTC-FIG4400	48.04
<b>MODEL 941B</b>							
BUCKET							
	7J6789		P-UB-10	2	4	CTC-7X2789	102.01
	8J5663		P-UB-10	2	4	CTC-7X2789	102.01
LIFT LH							
	6J3082		P-UB-10	2-1/4	4	CTC-7X2802	91.69
	7J9862		P-UB-10	2-1/4	4	CTC-7X2802	91.69
	9J5726		P-UB-10	2-1/4	4	CTC-7X2802	91.69
LIFT RH							
	6J3081		P-UB-10	2-1/4	4	CTC-7X2802	91.69
	7J9861		P-UB-10	2-1/4	4	CTC-7X2802	91.69
	9J5725		P-UB-10	2-1/4	4	CTC-7X2802	91.69
M.P. BUCKET							
	8J5663		P-UB-10	2	4	CTC-7X2789	102.01
M.P. BUCKET LH							
	6J2806		P-UB-10	2	4	CTC-7X2789	102.01

CATERPILLAR®



## REPLACEMENT KITS FOR CATERPILLAR® EQUIPMENT

<b>Crawler Loaders</b>							
APPLICATION	CYL #	Misc-Parts, Instructions, etc.	CODE	ROD	BORE	KIT #	List \$
<b>MODEL 941B</b>							
M.P. BUCKET RH							
	6J2805		P-UB-10	2	4	CTC-7X2789	102.01
RIPPER							
	6J3308		P-UB-10	2-1/2	5-1/2	CTC-8T1374	93.39
	6J3308		P-UB-10	2-1/2	5-1/2	CTC-9X2050	100.69
SIDE DUMP							
	8J5670		P-UB-10	2	4	CTC-7X2755	147.15
	8J5670		P-UB-10	2	4	CTC-7X7937	160.47
TILT							
			P-UB-10	2-3/8	4	CTC-2418925	56.47
TRACK ADJUSTER							
			TRK ADJ			CTC-FIG4400	48.04
<b>MODEL 943</b>							
BUCKET							
	4T9387		P-UB-10	2	4	CTC-1328816	92.75
	9J4892		P-UB-10	2	4	CTC-7X2789	102.01
BUCKET TILT							
	1U4802		P-UB-10	2-1/2	4-3/4	CTC-7X2660	179.61
LIFT							
	4T1963		P-UB-10	2-1/4	4	CTC-1361171	101.36
	9J0532		P-UB-10	2-1/4	4	CTC-1361171	101.36
M.P. BUCKET							
	9J4892		P-UB-10	2	4	CTC-7X2789	102.01
RIPPER							
	3G1296		P-UB-10	2	4	CTC-1328816	92.75
TILT							
	1U4802		P-UB-10	2-1/2	4-3/4	CTC-7X2660	179.61
	3G4653		P-UB-10	2-1/2	4-3/4	CTC-7X2660	179.61
<b>MODEL 943B</b>							
BUCKET							
	4T9387		P-UB-10	2	4	CTC-1328816	92.75
LIFT							
	9T3623		P-UB-10	2-1/4	4	CTC-1361171	101.36
RIPPER							
	3G1296		P-UB-10	2	4	CTC-1328816	92.75
TILT							
	6E0257		P-UB-10	2-1/2	4-3/4	CTC-1328811	161.44
<b>MODEL 951</b>							
LIFT							
	7J9821		P-UB-10	2-1/4	4-1/4	CTC-7X2750	114.40
	7J9822		P-UB-10	2-1/4	4-1/4	CTC-7X2750	114.40
	9J5728		P-UB-10	2-1/4	4-1/4	CTC-7X2750	114.40
LIFT RH							
	9J5727		P-UB-10	2-1/4	4-1/4	CTC-7X2750	114.40
LOG FORK LH							
	8J5677		P-V-10	2	5	CTC-7X2763	135.46
LOG FORK RH							
	8J5676		P-V-10	2	5	CTC-7X2763	135.46
M.P. BUCKET LH							
	6J2806		P-UB-10	2	4	CTC-7X2789	102.01
M.P. BUCKET RH							
	6J2805		P-UB-10	2	4	CTC-7X2789	102.01
RIPPER							
	6J3308		P-UB-10	2-1/2	5-1/2	CTC-8T1374	93.39

CATERPILLAR®



## REPLACEMENT KITS FOR CATERPILLAR® EQUIPMENT

<b>Crawler Loaders</b>							
APPLICATION	CYL #	Misc-Parts, Instructions, etc.	CODE	ROD	BORE	KIT #	List \$
<b>MODEL 951</b>							
<b>TILT</b>							
	4T9387		P-UB-10	2	4	CTC-7X2789	102.01
	5J9815		P-UB-10	2-3/8	4-1/4	CTC-8T1464	53.61
	5J9816		P-UB-10	2-3/8	4-1/4	CTC-8T1464	53.61
	8J5939		P-UB-10	2-3/8	4-1/4	CTC-8T1464	53.61
<b>TILT LH</b>							
	2K3744		P-V-10	2	5	CTC-7X2763	135.46
	3G8083		P-UB-10	2-3/8	4-1/4	CTC-8T1464	53.61
<b>TILT RH</b>							
	2K3743		P-V-10	2	5	CTC-7X2763	135.46
	7J9833		P-UB-10	2-3/8	4-1/4	CTC-8T1464	53.61
<b>TRACK ADJUSTER</b>							
			TRK ADJ			CTC-FIG4400	48.04
<b>MODEL 951B, 951C</b>							
<b>BUCKET</b>							
	7J6789		P-UB-10	2	4	CTC-7X2789	102.01
	8J5663		P-UB-10	2	4	CTC-7X2789	102.01
<b>BUCKET LH</b>							
	6J2806		P-UB-10	2	4	CTC-7X2789	102.01
<b>BUCKET RH</b>							
	6J2805		P-UB-10	2	4	CTC-7X2789	102.01
<b>LIFT LH</b>							
	6J4014		P-UB-10	2-1/4	4-1/4	CTC-7X2750	114.40
	7J9822		P-UB-10	2-1/4	4-1/4	CTC-7X2750	114.40
	9J5728		P-UB-10	2-1/4	4-1/4	CTC-7X2750	114.40
<b>LIFT RH</b>							
	6J4013		P-UB-10	2-1/4	4-1/4	CTC-7X2750	114.40
	7J9821		P-UB-10	2-1/4	4-1/4	CTC-7X2750	114.40
	9J5727		P-UB-10	2-1/4	4-1/4	CTC-7X2750	114.40
<b>RIPPER</b>							
	6J3308		P-UB-10	2-1/2	5-1/2	CTC-9X2050	100.69
<b>SIDE DUMP</b>							
	8J5670		P-UB-10	2	4	CTC-7X2755	147.15
	8J5670		P-UB-10	2	4	CTC-7X7937	160.47
<b>TILT</b>							
	6J3308		P-UB-10	2-1/2	5-1/2	CTC-8T1374	93.39
	8J5939		P-UB-10	2-3/8	4-1/4	CTC-8T1464	53.61
<b>TILT LH</b>							
	3G8083		P-UB-10	2-3/8	4-1/4	CTC-8T1464	53.61
	5J9815		P-UB-10	2-3/8	4-1/4	CTC-8T1464	53.61
	5J9816		P-UB-10	2-3/8	4-1/4	CTC-8T1464	53.61
	7J9834		P-UB-10	2-3/8	4-1/4	CTC-8T1464	53.61
<b>TILT RH</b>							
	7J9833		P-UB-10	2-3/8	4-1/4	CTC-8T1464	53.61
	8J5939		P-UB-10	2-3/8	4-1/4	CTC-8T1464	53.61
<b>TRACK ADJUSTER</b>							
		951C only	TRK ADJ			CTC-FIG4400	48.04
<b>MODEL 953</b>							
<b>BUCKET</b>							
	4T9387		P-UB-10	2	4	CTC-1328816	92.75
	9J4892		P-UB-10	2	4	CTC-7X2789	102.01

**CATERPILLAR®**



## REPLACEMENT KITS FOR CATERPILLAR® EQUIPMENT

Crawler Loaders							
APPLICATION	CYL #	Misc-Parts, Instructions, etc.	CODE	ROD	BORE	KIT #	List \$
<b>MODEL 953</b>							
LIFT							
	3G0717		P-UB-10	2-1/2	4-3/4	CTC-7X2660	179.61
	3G0717		P-UB-10	2-1/2	4-3/4	CTC-7X2773	178.40
	4T0263		P-UB-10	2-1/2	4-3/4	CTC-1328811	161.44
	4T0263		P-UB-10	2-1/2	4-3/4	CTC-7X2660	179.61
	4T0263		P-UB-10	2-1/2	4-3/4	CTC-7X2673	178.40
	4T2098		P-UB-10	2-1/2	4-3/4	CTC-1328811	161.44
	4T2098		P-UB-10	2-1/2	4-3/4	CTC-7X2660	179.61
	4T2098		P-UB-10	2-1/2	4-3/4	CTC-7X2673	178.40
	9T3625	Rod Bearing width- 0.98"	P-UB-10	2-1/2	4-3/4	CTC-1361131	143.18
RIPPER							
	3G1296		P-UB-10	2	4	CTC-1328816	92.75
SIDE DUMP							
	9T0107		P-UB-10	2	4	CTC-7X2789	102.01
TILT							
	1U0418		P-UB-10	3	5-1/2	CTC-1281673	228.55
	4T1063		P-UB-10	2	4-1/4	CTC-7X2766	44.13
<b>MODEL 953B</b>							
BUCKET							
	4T9387		P-UB-10	2	4	CTC-1328816	92.75
LIFT							
	9T3625	Rod Bearing width- 0.98"	P-UB-10	2-1/2	4-3/4	CTC-1361131	143.18
RIPPER							
	3G1296		P-UB-10	2	4	CTC-1328816	92.75
TILT							
	1U0418		P-UB-10	3	5-1/2	CTC-1281673	228.55
<b>MODEL 953C</b>							
BUCKET							
	4T9387		P-UB-10	2	4	CTC-1328816	92.75
LIFT							
	9T3625	Rod Bearing width- 0.98"	P-UB-10	2-1/2	4-3/4	CTC-1361131	143.18
RIPPER							
	3G1296		P-UB-10	2	4	CTC-1328816	92.75
TILT							
	1U0418		P-UB-10	3	5-1/2	CTC-1281673	228.55
<b>MODEL 953D</b>							
BUCKET MP							
	LBP1-UP						
	2929044		P-UB-10	2	4	CTC-2929044K	69.02
LIFT							
	LBP1-UP						
	2488788		P-UB-10	65 mm	115 mm	CTC-2488788K	102.12
	2526337		P-UB-10	65 mm	115 mm	CTC-2526337K	103.89
RIPPER							
	9JW1-UP						
	2860814		P-UB-10	2	4	CTC-2860814K	69.07
TILT							
	LBP1-UP						
	2696483		P-UB-10	85 mm	140 mm	CTC-2696483K	127.86
<b>MODEL 955</b>							
LIFT							
	5J6342		P-UB-10	2-1/2	5-1/2	CTC-9X2050	100.69
	7J1730		P-UB-10	2-1/2	5-1/2	CTC-9X2047	108.20
	7J9640		P-UB-10	2-1/2	5-1/2	CTC-9X2047	108.20
LIFT LH							
	9J2399		P-UB-10	2-1/2	5-1/2	CTC-9X2047	108.20
	9J2399		P-UB-10	2-1/2	5-1/2	CTC-9X2050	100.69



## REPLACEMENT KITS FOR CATERPILLAR® EQUIPMENT

<b>Crawler Loaders</b>							
APPLICATION	CYL #	Misc-Parts, Instructions, etc.	CODE	ROD	BORE	KIT #	List \$
<b>MODEL 955</b>							
LIFT RH							
	9J2401		P-UB-10	2-1/2	5-1/2	CTC-9X2047	108.20
	9J2401		P-UB-10	2-1/2	5-1/2	CTC-9X2050	100.69
LOG FORK LH							
	8J5677		P-V-10	2	5	CTC-7X2763	135.46
LOG FORK RH							
	8J5676		P-V-10	2	5	CTC-7X2763	135.46
RIPPER							
	5J8190		P-UB-10	2-1/2	5-1/2	CTC-8T1374	93.39
TILT LH							
	2K3744		P-V-10	2	5	CTC-7X2763	135.46
	3G8081		P-UB-10	2-1/2	5	CTC-7X2658	174.24
TILT RH							
	2K3743		P-V-10	2	5	CTC-7X2763	135.46
	7J9637		P-UB-10	2-1/2	5	CTC-1304012	191.35
<b>MODEL 955C</b>							
BUCKET							
	7Y5100		P-UB-10	85 mm	130 mm	CTC-7Y5145	267.26
TRACK ADJUSTER							
			TRK ADJ			CTC-FIG4400	48.04
UNSPECIFIED APPLICATION							
	8J5676		P-V-10	2	5	CTC-7X2763	135.46
<b>MODEL 955E</b>							
BUCKET							
	7Y5100		P-UB-10	85 mm	130 mm	CTC-7Y5145	267.26
LOG FORK LH							
	8J5677		P-V-10	2	5	CTC-7X2763	135.46
LOG FORK RH							
	8J5676		P-V-10	2	5	CTC-7X2763	135.46
TRACK ADJUSTER							
			TRK ADJ			CTC-FIG4400	48.04
<b>MODEL 955F</b>							
TILT LH							
	2K3744		P-V-10	2	5	CTC-7X2763	135.46
TILT RH							
	2K3743		P-V-10	2	5	CTC-7X2763	135.46
TRACK ADJUSTER							
			TRK ADJ			CTC-FIG4400	48.04
<b>MODEL 955H</b>							
LOG FORK LH							
	8J5677		P-V-10	2	5	CTC-7X2763	135.46
LOG FORK RH							
	8J5676		P-V-10	2	5	CTC-7X2763	135.46
RIPPER							
	6J3308		P-UB-10	2-1/2	5-1/2	CTC-8T1374	93.39
	6J3308		P-UB-10	2-1/2	5-1/2	CTC-9X2050	100.69
TILT LH							
	2K3744		P-V-10	2	5	CTC-7X2763	135.46
TILT RH							
	2K3743		P-V-10	2	5	CTC-7X2763	135.46
TRACK ADJUSTER							
			TRK ADJ			CTC-FIG4400	48.04
<b>MODEL 955K</b>							
BUCKET LH							
	8J5704		P-V-10	2	4-1/2	CTC-1328783	74.66
BUCKET RH							
	8J5703		P-V-10	2	4-1/2	CTC-1328783	74.66

CATERPILLAR®



## REPLACEMENT KITS FOR CATERPILLAR® EQUIPMENT

<b>Crawler Loaders</b>							
APPLICATION	CYL #	Misc-Parts, Instructions, etc.	CODE	ROD	BORE	KIT #	List \$
<b>MODEL 955K</b>							
<b>CLAMP</b>							
	8J8498		P-V-10	2	4-1/2	CTC-1328783	74.66
<b>LIFT</b>							
	5J6342		P-UB-10	2-1/2	5-1/2	CTC-8T1374	93.39
	7J1730		P-UB-10	2-1/2	5-1/2	CTC-9X2047	108.20
	7J9640		P-UB-10	2-1/2	5-1/2	CTC-9X2047	108.20
<b>LIFT LH</b>							
	9J2399		P-UB-10	2-1/2	5-1/2	CTC-9X2050	100.69
<b>LIFT RH</b>							
	9J2401		P-UB-10	2-1/2	5-1/2	CTC-9X2050	100.69
<b>RIPPER</b>							
	5J8190		P-UB-10	2-1/2	5-1/2	CTC-8T1374	93.39
	5J8190		P-UB-10	2-1/2	5-1/2	CTC-9X2050	100.69
<b>TILT</b>							
	3G8081		P-UB-10	2-1/2	5	CTC-7X2658	174.24
<b>TILT LH</b>							
	5J6214		P-UB-10	2-1/2	5	CTC-1304012	191.35
	7J9638		P-UB-10	2-1/2	5	CTC-7X2658	174.24
<b>TILT RH</b>							
	5J6213		P-UB-10	2-1/2	5	CTC-1304012	191.35
	7J9637		P-UB-10	2-1/2	5	CTC-7X2658	174.24
<b>TRACK ADJUSTER</b>							
			TRK ADJ			CTC-FIG3400	59.82
			TRK ADJ			CTC-FIG4400	48.04
<b>MODEL 955L</b>							
<b>BUCKET LH</b>							
	8J5704		P-V-10	2	4-1/2	CTC-1328783	74.66
<b>BUCKET RH</b>							
	8J5703		P-V-10	2	4-1/2	CTC-1328783	74.66
<b>CLAMP</b>							
	8J8498		P-V-10	2	4-1/2	CTC-1328783	74.66
<b>LIFT</b>							
	5J6342		P-UB-10	2-1/2	5-1/2	CTC-8T1374	93.39
	7J1730		P-UB-10	2-1/2	5-1/2	CTC-9X2047	108.20
	7J9640		P-UB-10	2-1/2	5-1/2	CTC-9X2047	108.20
<b>LIFT LH</b>							
	9J2399		P-UB-10	2-1/2	5-1/2	CTC-9X2050	100.69
<b>LIFT RH</b>							
	9J2401		P-UB-10	2-1/2	5-1/2	CTC-9X2050	100.69
<b>RIPPER</b>							
	5J8190		P-UB-10	2-1/2	5-1/2	CTC-9X2050	100.69
<b>TILT</b>							
	3G8081		P-UB-10	2-1/2	5	CTC-7X2658	174.24
<b>TILT LH</b>							
	5J6214		P-UB-10	2-1/2	5	CTC-1304012	191.35
	7J9638		P-UB-10	2-1/2	5	CTC-7X2658	174.24
<b>TILT RH</b>							
	5J6213		P-UB-10	2-1/2	5	CTC-1304012	191.35
	7J9637		P-UB-10	2-1/2	5	CTC-7X2658	174.24
<b>TRACK ADJUSTER</b>							
			TRK ADJ			CTC-FIG3400	59.82
<b>MODEL 963</b>							
<b>CLAMP</b>							
	8J8498		P-V-10	2	4-1/2	CTC-1328783	74.66
<b>DOZER TILT</b>							
	4T1625		P-UB-10	2-1/4	4-3/4	CTC-7X2815	96.71

CATERPILLAR®



## REPLACEMENT KITS FOR CATERPILLAR® EQUIPMENT

<b>Crawler Loaders</b>							
APPLICATION	CYL #	Misc-Parts, Instructions, etc.	CODE	ROD	BORE	KIT #	List \$
<b>MODEL 963</b>							
LIFT							
	4T0263		P-UB-10	2-1/2	4-3/4	CTC-1328811	161.44
	9J8002		P-UB-10	2-3/4	5-1/2	CTC-1327131	200.35
RIPPER							
	9J9881		P-UB-10	2-1/4	4-1/2	CTC-1326770	150.17
RIPPER LIFT							
	8J1779		P-UB-10	2-1/2	7-1/4	CTC-7X2661	180.93
RIPPER RH							
	1U3497		P-UB-10	2-1/4	4-1/2	CTC-1326770	150.17
TILT							
	3G3874		P-UB-10	3-3/4	6-1/2	CTC-7X2731	259.04
	4T1625		P-UB-10	2-1/4	4-3/4	CTC-7X2815	96.71
	9T1403		P-UB-10	3	6	CTC-7X2698	186.32
TRACK ADJUSTER							
			TRK ADJ			CTC-FIG3400	59.82
			TRK ADJ			CTC-FIG3401	55.84
<b>MODEL 963B, 963C</b>							
CLAMP							
	8J8498		P-V-10	2	4-1/2	CTC-1328783	74.66
LIFT							
			P-UB-10	2-3/4	5-1/2	CTC-2601518	123.02
RIPPER							
	1228420		P-UB-10	2-1/4	4-1/2	CTC-1326770	150.17
RIPPER RH							
	1228421		P-UB-10	2-1/4	4-1/2	CTC-1326770	150.17
TILT							
	3G3874		P-UB-10	3-3/4	6-1/2	CTC-7X2731	259.04
<b>MODEL 963D</b>							
BUCKET MP							
	LCS1-UP						
	2929043		P-UB-10	2	4-1/2	CTC-2929043K	61.82
LIFT LH							
	LCS1-UP						
	2469101		P-UB-10	3	5	CTC-2469101K	106.76
LIFT RH							
	LCS1-UP						
	2940509		P-UB-10	3	5	CTC-2940509K	109.24
RIPPER LH							
	8XR1-UP						
	2860813		P-UB-10	2-1/4	4-1/2	CTC-3110662	68.90
RIPPER RH							
	8XR1-UP						
	2860812		P-UB-10	2-1/4	4-1/2	CTC-3110662	68.90
TILT							
	LCS1-UP						
	2940510		P-UB-10	95 mm	150 mm	CTC-2940510K	204.91
<b>MODEL 973</b>							
BUCKET							
	9J1822		P-UB-10	2	5	CTC-7X2788	118.64
LIFT							
	3G0218		P-UB-10	3-1/4	6-1/2	CTC-7X2711	209.68
	4T2098		P-UB-10	2-1/2	4-3/4	CTC-1328811	161.44
RIPPER							
	3G1194		P-UB-10	2-1/2	5	CTC-1315106	168.91
	4T7606		P-UB-10	2-1/2	5	CTC-7X2658	174.24

**CATERPILLAR®**





## REPLACEMENT KITS FOR CATERPILLAR® EQUIPMENT

Crawler Loaders							
APPLICATION	CYL #	Misc-Parts, Instructions, etc.	CODE	ROD	BORE	KIT #	List \$
<b>MODEL 973</b>							
TILT							
	3G5949		P-UB-10	3-1/4	5-1/2	CTC-7X2712	92.64
	3G6571		P-UB-10	2-1/2	4-3/4	CTC-7X2773	178.40
TRACK ADJUSTER							
			TRK ADJ			CTC-FIG3400	59.82
			TRK ADJ			CTC-FIG3401	55.84
<b>MODEL 973C</b>							
BUCKET							
	9J1822		P-UB-10	2	5	CTC-7X2788	118.64
RIPPER							
	4T7606		P-UB-10	2-1/2	5	CTC-7X2658	174.24
TILT							
	3G5949		P-UB-10	3-1/4	5-1/2	CTC-7X2712	92.64
<b>MODEL 977</b>							
LIFT LH							
	7J9376		P-UB-10	2-3/4	6-1/2	CTC-9X2473	134.57
LIFT RH							
	7J9375		P-UB-10	2-3/4	6-1/2	CTC-9X2473	134.57
LIFT STEEL							
	3G8118		P-V-10	2-3/4	6-1/2	CTC-8T1554	137.77
LOG FORK							
	1K8206		P-V-10	2	5	CTC-7X2763	135.46
	8J5755		P-UB-10	2-1/4	5	CTC-7X2729	162.34
LOG FORK LH							
	8J5677		P-V-10	2	5	CTC-7X2763	135.46
LOG FORK RH							
	8J5676		P-V-10	2	5	CTC-7X2763	135.46
M.P. BUCKET							
	9J1822		P-UB-10	2	5	CTC-7X2788	118.64
	9J1822		P-V-10	2	5	CTC-7X2797	70.91
RIPPER							
	5J7686		P-UB-10	2-1/2	6-1/2	CTC-7X2666	169.85
TILT LH							
	9J0670		P-V-10	2-3/4	6	CTC-8T1553	112.98
	9J0673		P-UB-10	2-3/4	6	CTC-7X2803	171.39
TILT RH							
	9J0671		P-V-10	2-3/4	6	CTC-8T1553	112.98
	9J0672		P-UB-10	2-3/4	6	CTC-7X2803	171.39
TILT STEEL							
	3G8119		P-V-10	2-3/4	6-1/2	CTC-8T1554	137.77
<b>MODEL 977D</b>							
TRACK ADJUSTER							
			TRK ADJ			CTC-FIG3400	59.82
<b>MODEL 977H</b>							
M.P. BUCKET							
	8J5733		P-V-10	2	5	CTC-7X2763	135.46
RIPPER							
	2K3663		P-UB-10	2-1/2	7-1/4	CTC-7X2661	180.93
RIPPER LIFT							
	8J1779		P-UB-10	2-1/2	7-1/4	CTC-7X2661	180.93
TRACK ADJUSTER							
			TRK ADJ			CTC-FIG3400	59.82
<b>MODEL 977K</b>							
BUCKET							
	8J5761		P-UB-10	2-1/2	5-1/2	CTC-9X2050	100.69
	9J1822		P-UB-10	2	5	CTC-7X2788	118.64

CATERPILLAR®



## REPLACEMENT KITS FOR CATERPILLAR® EQUIPMENT

<b>Crawler Loaders</b>							
APPLICATION	CYL #	Misc-Parts, Instructions, etc.	CODE	ROD	BORE	KIT #	List \$
<b>MODEL 977K</b>							
LIFT LH							
	3G8118		P-V-10	2-3/4	6-1/2	CTC-8T1554	137.77
	7J9376		P-UB-10	2-3/4	6-1/2	CTC-7X2686	120.72
LIFT RH							
	3G8119		P-V-10	2-3/4	6-1/2	CTC-8T1554	137.77
	7J9375		P-UB-10	2-3/4	6-1/2	CTC-7X2686	120.72
LOG FORK							
	8J5755		P-UB-10	2-1/4	5	CTC-7X2729	162.34
RIPPER							
	5J7686		P-UB-10	2-1/2	6-1/2	CTC-7X2666	169.85
SIDE DUMP							
	5J9893		P-UB-10	2-1/2	5	CTC-1315106	168.91
TILT							
	3G8119		P-V-10	2-3/4	6-1/2	CTC-8T1554	137.77
TILT BUCKET LH							
	8J5740		P-UB-10	2	5	CTC-7X2788	118.64
TILT BUCKET RH							
	8J5739		P-UB-10	2	5	CTC-7X2788	118.64
TILT LH							
	9J0670		P-V-10	2-3/4	6	CTC-8T1553	112.98
	9J0673		P-UB-10	2-3/4	6	CTC-7X2803	171.39
TILT RH							
	9J0671		P-V-10	2-3/4	6	CTC-8T1553	112.98
	9J0672		P-UB-10	2-3/4	6	CTC-7X2803	171.39
TRACK ADJUSTER							
			TRK ADJ			CTC-FIG3400	59.82
<b>MODEL 977L</b>							
BUCKET							
	8J5761		P-UB-10	2-1/2	5-1/2	CTC-9X2050	100.69
	9J1822		P-UB-10	2	5	CTC-7X2788	118.64
LIFT LH							
	3G8118		P-V-10	2-3/4	6-1/2	CTC-8T1554	137.77
	7J9376		P-UB-10	2-3/4	6-1/2	CTC-7X2686	120.72
LIFT RH							
	3G8119		P-V-10	2-3/4	6-1/2	CTC-8T1554	137.77
	7J9375		P-UB-10	2-3/4	6-1/2	CTC-7X2686	120.72
LOG FORK							
	8J5755		P-UB-10	2-1/4	5	CTC-7X2729	162.34
RIPPER							
	5J7686		P-UB-10	2-1/2	6-1/2	CTC-7X2666	169.85
SIDE DUMP							
	5J9893		P-UB-10	2-1/2	5	CTC-1315106	168.91
TILT BUCKET LH							
	8J5740		P-UB-10	2	5	CTC-7X2788	118.64
TILT BUCKET RH							
	8J5739		P-UB-10	2	5	CTC-7X2788	118.64
TILT LH							
	9J0670		P-V-10	2-3/4	6	CTC-8T1553	112.98
	9J0673		P-UB-10	2-3/4	6	CTC-7X2803	171.39
TILT RH							
	9J0671		P-V-10	2-3/4	6	CTC-8T1553	112.98
	9J0672		P-UB-10	2-3/4	6	CTC-7X2803	171.39
TRACK ADJUSTER							
			TRK ADJ			CTC-FIG3400	59.82
<b>MODEL 983</b>							
BUCKET CLAMP							
	8J5772		P-UB-10	2-1/2	6	CTC-7X2669	233.76

**CATERPILLAR®**



## REPLACEMENT KITS FOR CATERPILLAR® EQUIPMENT

<b>Crawler Loaders</b>							
APPLICATION	CYL #	Misc-Parts, Instructions, etc.	CODE	ROD	BORE	KIT #	List \$
<b>MODEL 983</b>							
BUCKET DEMOLITION							
	8J5772		P-UB-10	2-1/2	6	CTC-7X2669	233.76
<b>Dump Trucks - Articulated</b>							
APPLICATION	CYL #	Misc-Parts, Instructions, etc.	CODE	ROD	BORE	KIT #	List \$
<b>MODEL D25C</b>							
HOIST							
	5U7777		I-U-3	3-1/2	5-1/2	CTC-5U7775	321.85
	6U6821		I-U-3	3-1/2	5-1/2	CTC-5U7775	321.85
STEERING							
	6U1040		I-U-5	2	4-1/2	CTC-6U9552	223.15
	7U2910		I-U-5	2	4-1/2	CTC-6U9552	223.15
SUSPENSION FRONT							
	6U4161		I-U-10	4	4-1/2	CTC-1045008	278.38
UNSPECIFIED APPLICATION							
	7U9508		I-U-10	4	4-1/2	CTC-1045008	278.38
<b>MODEL D25D</b>							
STEERING							
	1433299		I-UB-10	2	4-1/2	CTC-1857699	215.23
	1453620		P-UB-10	2	4-1/2	CTC-1857700	97.13
	7U2910		I-U-5	2	4-1/2	CTC-6U9552	223.15
SUSPENSION							
	1049660		P-UB-10	3-1/2	4-1/2	CTC-1942756	330.57
SUSPENSION REAR							
	7U9538		I-UB-10	2	4-1/2	CTC-7U9545	308.97
UNSPECIFIED APPLICATION							
	1511179		P-UB-10	3-1/2	4-1/2	CTC-1944399	244.46
	5U7777		I-U-3	3-1/2	5-1/2	CTC-5U7775	321.85
<b>MODEL D30C</b>							
HOIST							
	5U7777		I-U-3	3-1/2	5-1/2	CTC-5U7775	321.85
STEERING							
	6U1040		I-U-5	2	4-1/2	CTC-6U9552	223.15
	7U2910		I-U-5	2	4-1/2	CTC-6U9552	223.15
SUSPENSION FRONT							
	6U4161		I-U-10	4	4-1/2	CTC-1045008	278.38
UNSPECIFIED APPLICATION							
	7U9508		I-U-10	4	4-1/2	CTC-1045008	278.38
<b>MODEL D30D</b>							
STEERING							
	1433299		I-UB-5	2	4-1/2	CTC-1721689	182.89
	1453620		P-UB-10	2	4-1/2	CTC-1721690	48.61
	7U2910		I-U-5	2	4-1/2	CTC-6U9552	223.15
SUSPENSION							
	1049660		P-UB-4	3-1/2	4-1/2	CTC-1417975	159.90
	2U9448		I-U-10	4	4-1/2	CTC-1045008	278.38
SUSPENSION REAR							
	7U9538		I-UB-10	2	4-1/2	CTC-7U9545	308.97
UNSPECIFIED APPLICATION							
	5U7777		I-U-3	3-1/2	5-1/2	CTC-5U7775	321.85
	7U9508		I-U-10	4	4-1/2	CTC-1045008	278.38
<b>MODEL D35C</b>							
HOIST							
	5U7777		I-U-3	3-1/2	5-1/2	CTC-5U7775	321.85
STEERING							
	6U1040		I-U-5	2	4-1/2	CTC-6U9552	223.15
	7U2910		I-U-5	2	4-1/2	CTC-6U9552	223.15

CATERPILLAR®



## REPLACEMENT KITS FOR CATERPILLAR® EQUIPMENT

Dump Trucks - Articulated							
APPLICATION	CYL #	Misc-Parts, Instructions, etc.	CODE	ROD	BORE	KIT #	List \$
<b>MODEL D35C</b>							
SUSPENSION FRONT							
	6U4161		I-U-10	4	4-1/2	CTC-1045008	278.38
<b>MODEL D35HP</b>							
HOIST							
	5U7777		I-U-3	3-1/2	5-1/2	CTC-5U7775	321.85
STEERING							
	6U1040		I-U-5	2	4-1/2	CTC-6U9552	223.15
<b>MODEL D35HPC</b>							
STEERING							
	7U2910		I-U-5	2	4-1/2	CTC-6U9552	223.15
UNSPECIFIED APPLICATION							
	5U7777		I-U-3	3-1/2	5-1/2	CTC-5U7775	321.85
	6U4161		I-U-10	4	4-1/2	CTC-1045008	278.38
	7U2910		I-U-5	2	4-1/2	CTC-6U9552	223.15
<b>MODEL D40D</b>							
STEERING							
	1453620		P-UB-10	2	4-1/2	CTC-1721690	48.61
	7U2910		I-U-5	2	4-1/2	CTC-6U9552	223.15
SUSPENSION							
	1049660		P-UB-4	3-1/2	4-1/2	CTC-1417975	159.90
SUSPENSION REAR							
	7U9538		I-UB-5	2	4-1/2	CTC-1721689	182.89
<b>MODEL D250B</b>							
HOIST							
	1434850		P-UB-10	3-1/2	5-1/2	CTC-1721691	171.89
	5U7773		I-U-3	3-1/2	5-1/2	CTC-5U7775	321.85
STEERING							
	5U9000		I-U-5	2	4-1/2	CTC-6U9552	223.15
<b>MODEL D250D</b>							
HOIST							
	1478507		P-UB-10	2-3/4	4	CTC-1944397	165.38
	7U6405		I-U-10	2-3/4	4	CTC-7U8075	256.06
SUSPENSION							
	7U7230		P-UB-10	4	4-1/2	CTC-1944396	243.97
UNSPECIFIED APPLICATION							
	1340006		P-UB-10	4	4-1/2	CTC-1944396	243.97
	1512611		P-UB-10	2	3	CTC-1857667	84.68
<b>MODEL D250E</b>							
HOIST							
	1218785		I-U-10	2-3/4	4	CTC-1915027	117.42
	1256187		P-U-10	3	4	CTC-1315423	212.85
	1478507		P-UB-10	2-3/4	4	CTC-1944397	165.38
STEERING							
	1185432		N-UB-10	2	4	CTC-1857687	143.28
	1466651		N-UB-10	2	4	CTC-1857687	143.28
SUSPENSION							
	1185432		N-UB-10	2	4	CTC-1857687	143.28
UNSPECIFIED APPLICATION							
	1340006		P-UB-10	4	4-1/2	CTC-1944396	243.97
	1447657		P-UB-10	4	4-1/2	CTC-1944396	243.97
	1512611		P-UB-10	2	3	CTC-1857667	84.68
	7U7230		P-UB-10	4	4-1/2	CTC-1944396	243.97
<b>MODEL D300B</b>							
HOIST							
	1434850		P-UB-10	3-1/2	5-1/2	CTC-1721691	171.89
	5U7773		I-U-3	3-1/2	5-1/2	CTC-5U7775	321.85

CATERPILLAR®



## REPLACEMENT KITS FOR CATERPILLAR® EQUIPMENT

Dump Trucks - Articulated							
APPLICATION	CYL #	Misc-Parts, Instructions, etc.	CODE	ROD	BORE	KIT #	List \$
<b>MODEL D300B</b>							
STEERING							
	5U9000		I-U-5	2	4-1/2	CTC-6U9552	223.15
<b>MODEL D300B AG, D300B CANE H</b>							
STEERING							
	5U9000		I-U-5	2	4-1/2	CTC-6U9552	223.15
<b>MODEL D350B</b>							
HOIST							
	5U7773		I-U-3	3-1/2	5-1/2	CTC-5U7775	321.85
<b>MODEL D350C</b>							
HOIST							
	1434850		P-UB-10	3-1/2	5-1/2	CTC-1721691	171.89
	5U7773		I-U-3	3-1/2	5-1/2	CTC-5U7775	321.85
STEERING							
	6U1040		I-U-5	2	4-1/2	CTC-6U9552	223.15
	7U2910		I-U-5	2	4-1/2	CTC-6U9552	223.15
SUSPENSION							
	6U4161	App requires 2 kits.	I-U-10	4	4-1/2	CTC-1045008	278.38
UNSPECIFIED APPLICATION							
	7U2476		I-U-10	4	4-1/2	CTC-7U2486	322.85
<b>MODEL D350D</b>							
HOIST							
	1434850		P-UB-10	3-1/2	5-1/2	CTC-1721691	171.89
STEERING							
	1433299		I-UB-5	2	4-1/2	CTC-1721689	182.89
	1453620		P-UB-10	2	4-1/2	CTC-1721690	48.61
SUSPENSION							
	1049660		P-UB-4	3-1/2	4-1/2	CTC-1417975	159.90
SUSPENSION REAR							
	7U9538		I-UB-5	2	4-1/2	CTC-1721689	182.89
<b>MODEL D350D, D350E</b>							
STEERING							
	7U2910		I-U-5	2	4-1/2	CTC-6U9552	223.15
SUSPENSION							
	2U8060		I-U-10	4	4-1/2	CTC-1045008	278.38
	7U7198		I-U-10	4	4-1/2	CTC-1045008	278.38
SUSPENSION REAR							
	7U9538		I-UB-10	2	4-1/2	CTC-7U9545	308.97
UNSPECIFIED APPLICATION							
	5U7773		I-U-3	3-1/2	5-1/2	CTC-5U7775	321.85
	7U2476		I-U-10	4	4-1/2	CTC-7U2486	322.85
<b>MODEL D350E</b>							
HOIST							
	1434850		P-UB-10	3-1/2	5-1/2	CTC-1721691	171.89
STEERING							
	1433299		I-UB-5	2	4-1/2	CTC-1721689	182.89
	1453620		P-UB-10	2	4-1/2	CTC-1721690	48.61
SUSPENSION							
	1049660		P-UB-4	3-1/2	4-1/2	CTC-1417975	159.90
SUSPENSION REAR							
	7U9538		I-UB-5	2	4-1/2	CTC-1721689	182.89
<b>MODEL D400</b>							
HOIST							
	1434850		P-UB-10	3-1/2	5-1/2	CTC-1721691	171.89
	5U7773		I-U-3	3-1/2	5-1/2	CTC-5U7775	321.85
STEERING							
	6U1040		I-U-5	2	4-1/2	CTC-6U9552	223.15
	7U2910		I-U-5	2	4-1/2	CTC-6U9552	223.15

CATERPILLAR®



## REPLACEMENT KITS FOR CATERPILLAR® EQUIPMENT

<b>Dump Trucks - Articulated</b>							
APPLICATION	CYL #	Misc-Parts, Instructions, etc.	CODE	ROD	BORE	KIT #	List \$
<b>MODEL D400D</b>							
<b>STEERING</b>							
	7U2910		I-U-5	2	4-1/2	CTC-6U9552	223.15
<b>SUSPENSION</b>							
	1049660		P-UB-10	3-1/2	4-1/2	CTC-1942756	330.57
	2U8060		I-U-10	4	4-1/2	CTC-1045008	278.38
	7U7198		I-U-10	4	4-1/2	CTC-1045008	278.38
<b>SUSPENSION REAR</b>							
	7U9538		I-UB-10	2	4-1/2	CTC-7U9545	308.97
<b>MODEL D400E</b>							
<b>HOIST</b>							
	1434850		P-UB-10	3-1/2	5-1/2	CTC-1890263	245.88
<b>STEERING</b>							
	1433299		I-UB-10	2	4-1/2	CTC-1857699	215.23
	1453620		P-UB-10	2	4-1/2	CTC-1857700	97.13
	7U2910		I-U-5	2	4-1/2	CTC-6U9552	223.15
<b>SUSPENSION</b>							
	1049660		P-UB-10	3-1/2	4-1/2	CTC-1942756	330.57
	2U8060		I-U-10	4	4-1/2	CTC-1045008	278.38
	7U7198		I-U-10	4	4-1/2	CTC-1045008	278.38
<b>SUSPENSION REAR</b>							
	7U9538		I-UB-10	2	4-1/2	CTC-1857699	215.23
<b>UNSPECIFIED APPLICATION</b>							
	1331584		P-UB-10	4	4-1/2	CTC-1944398	229.55
	1511179		P-UB-10	3-1/2	4-1/2	CTC-1944399	244.46
	1512611		P-UB-10	2	3	CTC-1857667	84.68
	5U7773		I-U-3	3-1/2	5-1/2	CTC-5U7775	321.85
	7U2476		I-U-10	4	4-1/2	CTC-7U2486	322.85
<b>Excavators</b>							
APPLICATION	CYL #	Misc-Parts, Instructions, etc.	CODE	ROD	BORE	KIT #	List \$
<b>MODEL 215</b>							
<b>BOOM</b>							
	8J8613		P-UB-10	2-3/4	4-1/2	CTC-7X2683	182.71
<b>BUCKET</b>							
	8J8612		P-UB-10	2-3/4	4-1/2	CTC-7X2685	164.23
<b>CLAMSHELL</b>							
	9J5832		P-UB-10	3-1/4	6-1/2	CTC-7X2713	133.64
<b>STICK</b>							
	8J8611		P-UB-10	3-1/2	5-1/2	CTC-7X2726	150.36
<b>TRACK ADJUSTER</b>							
			TRK ADJ			CTC-FIG3400	59.82
			TRK ADJ			CTC-FIG3404	46.26
<b>MODEL 215B</b>							
<b>BOOM</b>							
	3G2996		P-UB-10	3-1/4	5-1/2	CTC-7X2705	258.00
	8J8613		P-UB-10	2-3/4	4-1/2	CTC-7X2683	182.71
<b>BUCKET</b>							
	8J8612		P-UB-10	2-3/4	4-1/2	CTC-7X2685	164.23
<b>CLAMSHELL</b>							
	9J5832		P-UB-10	3-1/4	6-1/2	CTC-7X2713	133.64
<b>STICK</b>							
	8J8611		P-UB-10	3-1/2	5-1/2	CTC-7X2726	150.36
<b>TRACK ADJUSTER</b>							
			TRK ADJ			CTC-FIG3400	59.82
<b>MODEL 215C</b>							
<b>BOOM</b>							
	8J8613		P-UB-10	2-3/4	4-1/2	CTC-7X2683	182.71

**CATERPILLAR®**



## REPLACEMENT KITS FOR CATERPILLAR® EQUIPMENT

Excavators							
APPLICATION	CYL #	Misc-Parts, Instructions, etc.	CODE	ROD	BORE	KIT #	List \$
<b>MODEL 215C</b>							
BUCKET							
	8J8612		P-UB-10	2-3/4	4-1/2	CTC-7X2685	164.23
	9T6497		P-UB-10	3	4-3/4	CTC-3E8883	155.39
STICK							
	8J8611		P-UB-10	3-1/2	5-1/2	CTC-7X2726	150.36
TRACK ADJUSTER							
			TRK ADJ			CTC-FIG3400	59.82
			TRK ADJ			CTC-FIG3404	46.26
<b>MODEL 215D</b>							
BOOM							
	8J8613		P-UB-10	2-3/4	4-1/2	CTC-7X2683	182.71
BUCKET							
	9T6497		P-UB-10	3	4-3/4	CTC-3E8883	155.39
STICK							
	9T9280		P-UB-10	3-1/2	5-1/2	CTC-7X2726	150.36
TRACK ADJUSTER							
			TRK ADJ			CTC-FIG3400	59.82
			TRK ADJ			CTC-FIG3404	46.26
<b>MODEL 219</b>							
BOOM							
	8J8613		P-UB-10	2-3/4	4-1/2	CTC-7X2683	182.71
BUCKET							
	8J8612		P-UB-10	2-3/4	4-1/2	CTC-7X2685	164.23
	9T6497		P-UB-10	3	4-3/4	CTC-3E8883	155.39
STICK							
	8J8611		P-UB-10	3-1/2	5-1/2	CTC-7X2726	150.36
TRACK ADJUSTER							
			TRK ADJ			CTC-FIG3400	59.82
			TRK ADJ			CTC-FIG3404	46.26
<b>MODEL 219D</b>							
BUCKET							
	9T6497		P-UB-10	3	4-3/4	CTC-3E8883	155.39
STICK							
	9T9280		P-UB-10	3-1/2	5-1/2	CTC-7X2726	150.36
TRACK ADJUSTER							
			TRK ADJ			CTC-FIG3400	59.82
			TRK ADJ			CTC-FIG3404	46.26
<b>MODEL 225</b>							
BOOM							
	3G2996		P-UB-10	3-1/4	5-1/2	CTC-7X2705	258.00
	3G7384		P-UB-10	3-1/4	5-1/2	CTC-7X2705	258.00
	6E3833		P-UB-10	3-1/4	5-1/2	CTC-7X2705	258.00
	6E3836		P-UB-10	3-1/4	5-1/2	CTC-7X2705	258.00
	8J1698		P-UB-10	3-1/4	5-1/2	CTC-7X2705	258.00
	8J1698		P-UB-10	3-1/4	5-1/2	CTC-7X2823	237.08
BUCKET							
	6E6007		P-UB-10	3-1/4	5-1/2	CTC-7X2705	258.00
	8J2566		P-UB-10	3-1/4	5-1/2	CTC-7X2705	258.00
	8J8612		P-UB-10	2-3/4	4-1/2	CTC-7X2685	164.23
	9J7006		P-UB-10	3-1/4	5-1/2	CTC-1002931	396.42
CLAMHELL							
	9J5153		P-UB-10	3-1/2	8-1/4	CTC-7X2727	344.33
CONVEYOR SWING							
	9J5153		P-UB-10	3-1/2	8-1/4	CTC-7X2727	344.33

CATERPILLAR®





## REPLACEMENT KITS FOR CATERPILLAR® EQUIPMENT

Excavators							
APPLICATION	CYL #	Misc-Parts, Instructions, etc.	CODE	ROD	BORE	KIT #	List \$
<b>MODEL 225</b>							
STICK							
	8J1719		P-UB-10	3-3/4	6	CTC-7X2794	386.52
	9J1755		P-UB-10	3-3/4	6	CTC-1002939	551.13
	9T9744		P-UB-10	3-3/4	6	CTC-3E8888	316.59
<b>MODEL 225B</b>							
BOOM							
	3G2996		P-UB-10	3-1/4	5-1/2	CTC-7X2705	258.00
	6E3833		P-UB-10	3-1/4	5-1/2	CTC-7X2705	258.00
	8J1698		P-UB-10	3-1/4	5-1/2	CTC-7X2705	258.00
	8J1698		P-UB-10	3-1/4	5-1/2	CTC-7X2823	237.08
	9T5230		P-UB-10	3-1/2	6	CTC-3E8889	199.13
	9T5230		P-UB-10	3-1/2	6	CTC-7X7735	252.02
BUCKET							
	6E6007		P-UB-10	3-1/4	5-1/2	CTC-7X2705	258.00
	8J8612		P-UB-10	2-3/4	4-1/2	CTC-7X2685	164.23
	9J7006		P-UB-10	3-1/4	5-1/2	CTC-1002931	396.42
	9J7006		P-UB-10	3-1/4	5-1/2	CTC-1002932	396.91
	9J7006		P-UB-10	3-1/4	5-1/2	CTC-7X2709	161.53
	9T6497		P-UB-10	3	4-3/4	CTC-3E8883	155.39
STICK							
	9J1755		P-UB-10	3-3/4	6	CTC-1002939	551.13
	9J1755		P-UB-10	3-3/4	6	CTC-7X2794	386.52
	9T9744		P-UB-10	3-3/4	6	CTC-3E8888	316.59
TRACK ADJUSTER							
			TRK ADJ			CTC-FIG3400	59.82
<b>MODEL 225D</b>							
BOOM							
	3G2996		P-UB-10	3-1/4	5-1/2	CTC-7X2705	258.00
	9T5230		P-UB-10	3-1/2	6	CTC-7X7735	252.02
	9T9747		P-UB-10	3-1/2	6	CTC-3E8889	199.13
BUCKET							
	6E6007		P-UB-10	3-1/4	5-1/2	CTC-7X2705	258.00
	8J8612		P-UB-10	2-3/4	4-1/2	CTC-7X2685	164.23
	9J7006		P-UB-10	3-1/4	5-1/2	CTC-1002931	396.42
	9J7006		P-UB-10	3-1/4	5-1/2	CTC-1002932	396.91
	9J7006		P-UB-10	3-1/4	5-1/2	CTC-7X2709	161.53
	9T6497		P-UB-10	3	4-3/4	CTC-3E8883	155.39
STICK							
	6E6009		P-UB-10	3-3/4	6	CTC-1002939	551.13
	9J1755		P-UB-10	3-3/4	6	CTC-1002939	551.13
	9J1755		P-UB-10	3-3/4	6	CTC-7X2794	386.52
	9T9744		P-UB-10	3-3/4	6	CTC-1002939	551.13
	9T9744		P-UB-10	3-3/4	6	CTC-3E8888	316.59
TRACK ADJUSTER							
			TRK ADJ			CTC-FIG3400	59.82
<b>MODEL 227</b>							
ARM							
	1U4732		P-UB-10	3-3/4	6	CTC-7X2814	198.57
BOOM							
	3G2996		P-UB-10	3-1/4	5-1/2	CTC-7X2705	258.00
	3G7264		P-UB-10	3-1/4	5-1/2	CTC-7X2705	258.00
	6E3833		P-UB-10	3-1/4	5-1/2	CTC-7X2705	258.00
	8J1698		P-UB-10	3-1/4	5-1/2	CTC-7X2705	258.00
	8J1698		P-UB-10	3-1/4	5-1/2	CTC-7X2823	237.08

CATERPILLAR®



## REPLACEMENT KITS FOR CATERPILLAR® EQUIPMENT

Excavators							
APPLICATION	CYL #	Misc-Parts, Instructions, etc.	CODE	ROD	BORE	KIT #	List \$
<b>MODEL 227</b>							
BUCKET							
	6E6007		P-UB-10	3-1/4	5-1/2	CTC-7X2705	258.00
	9J7006		P-UB-10	3-1/4	5-1/2	CTC-1002931	396.42
	9J7006		P-UB-10	3-1/4	5-1/2	CTC-1002932	396.91
	9J7006		P-UB-10	3-1/4	5-1/2	CTC-7X2709	161.53
GRAPPLE							
	3G5672		P-UB-10	1-3/4	3	CTC-7X2791	88.60
SHEAR							
	3G2656		P-UB-10	3-1/4	6-1/2	CTC-7X2713	133.64
STICK							
	1U4731		P-UB-10	3-3/4	6	CTC-1002939	551.13
	9J1755		P-UB-10	3-3/4	6	CTC-1002939	551.13
	9J1755		P-UB-10	3-3/4	6	CTC-7X2794	386.52
	9T9744		P-UB-10	3-3/4	6	CTC-3E8888	316.59
TILT							
	3G9241		P-UB-10	2-1/2	4-1/2	CTC-7X2668	170.05
<b>MODEL 229</b>							
ARM							
	1U4732		P-UB-10	3-3/4	6	CTC-7X2814	198.57
BOOM							
	3G2996		P-UB-10	3-1/4	5-1/2	CTC-7X2705	258.00
	3G7264		P-UB-10	3-1/4	5-1/2	CTC-7X2705	258.00
	6E3833		P-UB-10	3-1/4	5-1/2	CTC-7X2705	258.00
	8J1698		P-UB-10	3-1/4	5-1/2	CTC-7X2705	258.00
	8J1698		P-UB-10	3-1/4	5-1/2	CTC-7X2823	237.08
	9T5230		P-UB-10	3-1/2	6	CTC-3E8889	199.13
	9T5230		P-UB-10	3-1/2	6	CTC-7X7735	252.02
BUCKET							
	6E6007		P-UB-10	3-1/4	5-1/2	CTC-7X2705	258.00
	9J7006		P-UB-10	3-1/4	5-1/2	CTC-1002931	396.42
	9J7006		P-UB-10	3-1/4	5-1/2	CTC-1002932	396.91
	9J7006		P-UB-10	3-1/4	5-1/2	CTC-7X2709	161.53
STICK							
	9J1755		P-UB-10	3-3/4	6	CTC-1002939	551.13
	9J1755		P-UB-10	3-3/4	6	CTC-7X2794	386.52
	9T9744		P-UB-10	3-3/4	6	CTC-3E8888	316.59
TRACK ADJUSTER							
			TRK ADJ			CTC-FIG3400	59.82
<b>MODEL 229D</b>							
BOOM							
	9T9371		P-UB-10	4	6	CTC-9X6261	283.98
	9T9371		P-UB-10	4	6	CTC-9X6263	233.98
BUCKET							
	6E6007		P-UB-10	3-1/4	5-1/2	CTC-7X2705	258.00
	9J7006		P-UB-10	3-1/4	5-1/2	CTC-1002931	396.42
	9J7006		P-UB-10	3-1/4	5-1/2	CTC-1002932	396.91
	9J7006		P-UB-10	3-1/4	5-1/2	CTC-7X2709	161.53
STICK							
	6E6009		P-UB-10	3-3/4	6	CTC-1002939	551.13
	9T9744		P-UB-10	3-3/4	6	CTC-1002939	551.13
	9T9744		P-UB-10	3-3/4	6	CTC-3E8888	316.59

CATERPILLAR®



## REPLACEMENT KITS FOR CATERPILLAR® EQUIPMENT

Excavators							
APPLICATION	CYL #	Misc-Parts, Instructions, etc.	CODE	ROD	BORE	KIT #	List \$
<b>MODEL 231D</b>							
BOOM							
	1052921		P-UB-10	4	6	CTC-9X6261	283.98
	6E3473		P-UB-10	4-1/4	6-1/2	CTC-8T1461	227.57
	8J4589		P-UB-10	4-1/4	6-1/2	CTC-1002934	401.89
	8J4589		P-UB-10	4-1/4	6-1/2	CTC-1002935	409.09
	8J4589		P-UB-10	4-1/4	6-1/2	CTC-8T1461	227.57
	9T9371		P-UB-10	4	6	CTC-9X6261	283.98
	9T9371		P-UB-10	4	6	CTC-9X6263	233.98
BUCKET							
	6E5021		P-UB-10	4	6	CTC-9X6261	283.98
	9T9514		P-UB-10	4	6	CTC-9X6261	283.98
<b>MODEL 235</b>							
BOOM							
	1024210		P-UB-10	4-1/4	6-1/2	CTC-8T1461	227.57
	3G3524		P-UB-10	4-3/4	7-1/4	CTC-8T1545	288.97
	4T1689		P-UB-10	4-1/4	6-1/2	CTC-8T1461	227.57
	4T1921		P-UB-10	4-1/4	6-1/2	CTC-8T1461	227.57
	6C5856		P-UB-10	4-1/4	6-1/2	CTC-8T1461	227.57
	6C5857		P-UB-10	4-1/4	6-1/2	CTC-8T1461	227.57
	8J4589		P-UB-10	4-1/4	6-1/2	CTC-1002934	401.89
	8J4589		P-UB-10	4-1/4	6-1/2	CTC-1002935	409.09
	8J4589		P-UB-10	4-1/4	6-1/2	CTC-8T1461	227.57
	9J2153		P-UB-10	4-1/4	6-1/2	CTC-8T1461	227.57
	9T9995		P-UB-10	4-1/4	6-1/2	CTC-8T1461	227.57
	9T9995		P-UB-10	4-1/4	6-1/2	CTC-9X6379	317.44
BOTTOM DUMP							
	1024216		P-UB-14	4-3/4	6-1/2	CTC-8T1462	243.48
	4T0483		P-UB-10	3	7-1/4	CTC-7X2699	215.29
BUCKET							
	1024216		P-UB-14	4-3/4	6-1/2	CTC-8T1462	243.48
	4T2536		P-UB-14	4-3/4	6-1/2	CTC-8T1462	243.48
	8J8918		P-UB-10	4-3/4	6-1/2	CTC-7X7719	265.67
	9J4100		P-UB-14	4-3/4	6-1/2	CTC-8T1462	243.48
	9J8153		P-UB-10	4-3/4	6	CTC-8T1908	217.82
PIN PULLER							
	1U2813		P-UB-10	2-1/2	4	CTC-7X2665	166.92
SLAVE							
	9J4882		P-UB-10	4	5	CTC-7X2816	252.86
STICK							
	3G5646		P-UB-10	5	7-3/4	CTC-8T1479	381.67
	6E5096		P-UB-10	5	7-3/4	CTC-3E8887	449.10
	8J5603		P-UB-10	5	7-3/4	CTC-8T1479	381.67
	9J1755		P-UB-10	3-3/4	6	CTC-1002939	551.13
	9J7850		P-UB-10	5	7-3/4	CTC-8T1479	381.67
	9T1387		P-UB-10	5	7-3/4	CTC-8T1479	381.67
	9T9354		P-UB-10	5	7-3/4	CTC-3E8887	449.10
	9T9744		P-UB-10	3-3/4	6	CTC-3E8888	316.59
<b>MODEL 235 FS</b>							
BOOM							
	4T1921		P-UB-10	4-1/4	6-1/2	CTC-8T1461	227.57
	8J4589		P-UB-10	4-1/4	6-1/2	CTC-1002934	401.89
	8J4589		P-UB-10	4-1/4	6-1/2	CTC-1002935	409.09
	8J4589		P-UB-10	4-1/4	6-1/2	CTC-8T1461	227.57
	9J2153		P-UB-10	4-1/4	6-1/2	CTC-8T1461	227.57
BOTTOM DUMP							
	4T0483		P-UB-10	3	7-1/4	CTC-7X2699	215.29
	9J4697		P-UB-10	3	7-1/4	CTC-7X2699	215.29

CATERPILLAR®



## REPLACEMENT KITS FOR CATERPILLAR® EQUIPMENT

Excavators							
APPLICATION	CYL #	Misc-Parts, Instructions, etc.	CODE	ROD	BORE	KIT #	List \$
<b>MODEL 235 FS</b>							
BUCKET							
	4T2536		P-UB-14	4-3/4	6-1/2	CTC-8T1462	243.48
	9J4100		P-UB-10	4-3/4	6-1/2	CTC-7X7718	251.23
	9J4100		P-UB-10	4-3/4	6-1/2	CTC-7X7719	265.67
	9J4100		P-UB-14	4-3/4	6-1/2	CTC-8T1462	243.48
	9J8153		P-UB-10	4-3/4	6	CTC-8T1908	217.82
SLAVE							
	9J4882		P-UB-10	4	5	CTC-7X2816	252.86
STICK							
	3G5646		P-UB-10	5	7-3/4	CTC-8T1479	381.67
<b>MODEL 235B</b>							
BOOM							
	1024210		P-UB-10	4-1/4	6-1/2	CTC-8T1461	227.57
	4T1689		P-UB-10	4-1/4	6-1/2	CTC-8T1461	227.57
	4T1921		P-UB-10	4-1/4	6-1/2	CTC-8T1461	227.57
	6C5856		P-UB-10	4-1/4	6-1/2	CTC-8T1461	227.57
	6C5857		P-UB-10	4-1/4	6-1/2	CTC-8T1461	227.57
	9T9995		P-UB-10	4-1/4	6-1/2	CTC-8T1461	227.57
	9T9995		P-UB-10	4-1/4	6-1/2	CTC-9X6379	317.44
BOTTOM DUMP							
	4T0483		P-UB-10	3	7-1/4	CTC-7X2699	215.29
BUCKET							
	1024217		P-UB-14	4-3/4	6-1/2	CTC-8T1462	243.48
	4T2536		P-UB-14	4-3/4	6-1/2	CTC-8T1462	243.48
	9J8153		P-UB-10	4-3/4	6	CTC-8T1908	217.82
SLAVE							
	9J4882		P-UB-10	4	5	CTC-7X2816	252.86
STICK							
	3G5646		P-UB-10	5	7-3/4	CTC-8T1479	381.67
	6E5096		P-UB-10	5	7-3/4	CTC-3E8887	449.10
	9T1387		P-UB-10	5	7-3/4	CTC-8T1479	381.67
	9T9354		P-UB-10	5	7-3/4	CTC-3E8887	449.10
<b>MODEL 235C</b>							
BOOM							
	1024211		P-UB-10	4-1/4	6-1/2	CTC-8T1461	227.57
	4T1689		P-UB-10	4-1/4	6-1/2	CTC-8T1461	227.57
	4T1921		P-UB-10	4-1/4	6-1/2	CTC-8T1461	227.57
	6C5856		P-UB-10	4-1/4	6-1/2	CTC-8T1461	227.57
	6C5857		P-UB-10	4-1/4	6-1/2	CTC-8T1461	227.57
	6E1643		P-UB-14	4-3/4	7	CTC-8T1567	238.41
	9T6615		P-UB-10	4-3/4	7	CTC-7X7734	433.49
	9T6615		P-UB-14	4-3/4	7	CTC-8T1567	238.41
	9T9360		P-UB-14	4-3/4	7	CTC-8T1567	238.41
	9T9995		P-UB-10	4-1/4	6-1/2	CTC-8T1461	227.57
	9T9995		P-UB-10	4-1/4	6-1/2	CTC-9X6379	317.44
BOTTOM DUMP							
	4T0483		P-UB-10	3	7-1/4	CTC-7X2699	215.29
BUCKET							
	1024216		P-UB-14	4-3/4	6-1/2	CTC-8T1462	243.48
	4T2536		P-UB-14	4-3/4	6-1/2	CTC-8T1462	243.48
	9J8153		P-UB-10	4-3/4	6	CTC-8T1908	217.82
SLAVE							
	9J4882		P-UB-10	4	5	CTC-7X2816	252.86



## REPLACEMENT KITS FOR CATERPILLAR® EQUIPMENT

Excavators							
APPLICATION	CYL #	Misc-Parts, Instructions, etc.	CODE	ROD	BORE	KIT #	List \$
<b>MODEL 235C</b>							
STICK							
	3G5646		P-UB-10	5	7-3/4	CTC-8T1479	381.67
	6E5096		P-UB-10	5	7-3/4	CTC-3E8887	449.10
	9T1387		P-UB-10	5	7-3/4	CTC-8T1479	381.67
	9T9354		P-UB-10	5	7-3/4	CTC-3E8887	449.10
<b>MODEL 235C FS</b>							
BOOM							
	4T1689		P-UB-10	4-1/4	6-1/2	CTC-8T1461	227.57
	9T6615		P-UB-10	4-3/4	7	CTC-7X7734	433.49
BOTTOM DUMP							
	4T0483		P-UB-10	3	7-1/4	CTC-7X2699	215.29
BUCKET							
	4T2536		P-UB-14	4-3/4	6-1/2	CTC-8T1462	243.48
	9J8153		P-UB-10	4-3/4	6	CTC-8T1908	217.82
MASTER							
	9J4882		P-UB-10	4	5	CTC-7X2816	252.86
STICK							
	9T1387		P-UB-10	5	7-3/4	CTC-8T1479	381.67
<b>MODEL 235D</b>							
BOOM							
	1024210		P-UB-10	4-1/4	6-1/2	CTC-8T1461	227.57
	4T1689		P-UB-10	4-1/4	6-1/2	CTC-8T1461	227.57
	6C5856		P-UB-10	4-1/4	6-1/2	CTC-8T1461	227.57
	6C5857		P-UB-10	4-1/4	6-1/2	CTC-8T1461	227.57
	6E1643		P-UB-14	4-3/4	7	CTC-8T1567	238.41
	9T9995		P-UB-10	4-1/4	6-1/2	CTC-8T1461	227.57
	9T9995		P-UB-10	4-1/4	6-1/2	CTC-9X6379	317.44
BOTTOM DUMP							
	4T0483		P-UB-10	3	7-1/4	CTC-7X2699	215.29
BUCKET							
	1024216		P-UB-14	4-3/4	6-1/2	CTC-8T1462	243.48
	4T2536		P-UB-14	4-3/4	6-1/2	CTC-8T1462	243.48
SLAVE							
	9J4882		P-UB-10	4	5	CTC-7X2816	252.86
STICK							
	6E5096		P-UB-10	5	7-3/4	CTC-3E8887	449.10
	9T9354		P-UB-10	5	7-3/4	CTC-3E8887	449.10
TRACK ADJUSTER							
			TRK ADJ			CTC-FIG0405	108.68
<b>MODEL 245 FS</b>							
BOOM							
	3G4615		P-UB-10	5	6	CTC-8T1909	337.75
	9J5379		P-UB-14	4-3/4	7	CTC-8T1567	238.41
BUCKET							
	1U1646		P-UB-14	4-3/4	7	CTC-8T1565	245.44
	8J8721		P-UB-14	4-3/4	7	CTC-8T1565	245.44
STICK							
	3G2778		P-UB-10	5-3/4	8-1/4	CTC-8T1558	665.65
<b>MODEL 245, 245B</b>							
BOOM							
	1024212		P-UB-14	4-3/4	7	CTC-8T1567	238.41
	3G3524		P-UB-10	4-3/4	7-1/4	CTC-8T1545	288.97
	3G4615		P-UB-10	5	6	CTC-8T1909	337.75
	8J3720		P-UB-14	4-3/4	7	CTC-8T1567	238.41
	9J5379		P-UB-14	4-3/4	7	CTC-8T1567	238.41
	9T9358		P-UB-10	4-3/4	7-1/4	CTC-8T1545	288.97

CATERPILLAR®



## REPLACEMENT KITS FOR CATERPILLAR® EQUIPMENT

<b>Excavators</b>							
APPLICATION	CYL #	Misc-Parts, Instructions, etc.	CODE	ROD	BORE	KIT #	List \$
<b>MODEL 245, 245B</b>							
<b>BOTTOM DUMP</b>							
	1U1659		P-UB-10	3-1/2	7-3/4	CTC-9X2644	231.80
<b>BUCKET</b>							
	1U1646		P-UB-14	4-3/4	7	CTC-8T1565	245.44
	1U1646		P-UB-14	4-3/4	7	CTC-8T1567	238.41
	1U1659		P-UB-10	3-1/2	7-3/4	CTC-9X2644	231.80
	8J8721		P-U-10	4-3/4	7	CTC-1371946	366.08
	8J8721		P-UB-14	4-3/4	7	CTC-8T1565	245.44
	9J7755		P-UB-10	5-3/4	7	CTC-8C4398	377.42
	9J9398		P-UB-10	5-3/4	7	CTC-8C4398	377.42
<b>COUNTERWEIGHT</b>							
	8J6167		P-UB-10	2-1/2	5	CTC-7X2658	174.24
<b>LIFT</b>							
	8J6167		P-UB-10	2-1/2	5	CTC-1315118	177.89
	8J6167		P-UB-10	2-1/2	5	CTC-7X2658	174.24
<b>STICK</b>							
	1011908		P-UB-10	5-3/4	8-1/4	CTC-3E8880	723.29
	3G2778		P-UB-10	5-3/4	8-1/4	CTC-3E8880	723.29
	3G2778		P-UB-10	5-3/4	8-1/4	CTC-8T1558	665.65
	6E5093		P-UB-10	5-3/4	8-1/4	CTC-3E8880	723.29
	9T1388		P-UB-10	5-3/4	8-1/4	CTC-3E8880	723.29
	9T1388		P-UB-10	5-3/4	8-1/4	CTC-8T1558	665.65
	9T9356		P-UB-10	5-3/4	8-1/4	CTC-3E8880	723.29
<b>TRACK ADJUSTER</b>							
			TRK ADJ			CTC-FIG0405	108.68
<b>MODEL 245B FS</b>							
<b>BOOM</b>							
	3G3524		P-UB-10	4-3/4	7-1/4	CTC-8T1545	288.97
	3G4615		P-UB-10	5	6	CTC-8T1909	337.75
	9J5379		P-UB-14	4-3/4	7	CTC-8T1567	238.41
<b>BUCKET</b>							
	1U1646		P-UB-14	4-3/4	7	CTC-8T1565	245.44
	8J8721		P-UB-14	4-3/4	7	CTC-8T1565	245.44
<b>STICK</b>							
	3G2778		P-UB-10	5-3/4	8-1/4	CTC-8T1558	665.65
<b>MODEL 245D</b>							
<b>BOOM</b>							
	1024212		P-UB-14	4-3/4	7	CTC-8T1567	238.41
	3G3524		P-UB-10	4-3/4	7-1/4	CTC-8T1545	288.97
	8J3720		P-UB-14	4-3/4	7	CTC-8T1567	238.41
	9J5379		P-UB-14	4-3/4	7	CTC-8T1567	238.41
	9T9358		P-UB-10	4-3/4	7-1/4	CTC-8T1545	288.97
<b>BOTTOM DUMP</b>							
	1U1659		P-UB-10	3-1/2	7-3/4	CTC-9X2644	231.80
<b>BUCKET</b>							
	1U1646		P-UB-14	4-3/4	7	CTC-8T1565	245.44
	1U1646		P-UB-14	4-3/4	7	CTC-8T1567	238.41
	8J8721		P-U-10	4-3/4	7	CTC-1371946	366.08
	9J9398		P-UB-10	5-3/4	7	CTC-8C4398	377.42
<b>LIFT</b>							
	8J6167		P-UB-10	2-1/2	5	CTC-1315118	177.89
	8J6167		P-UB-10	2-1/2	5	CTC-7X2658	174.24

**CATERPILLAR®**



## REPLACEMENT KITS FOR CATERPILLAR® EQUIPMENT

Excavators							
APPLICATION	CYL #	Misc-Parts, Instructions, etc.	CODE	ROD	BORE	KIT #	List \$
<b>MODEL 245D</b>							
STICK							
	1011908		P-UB-10	5-3/4	8-1/4	CTC-3E8880	723.29
	3G2778		P-UB-10	5-3/4	8-1/4	CTC-3E8880	723.29
	6E5093		P-UB-10	5-3/4	8-1/4	CTC-3E8880	723.29
	9T1388		P-UB-10	5-3/4	8-1/4	CTC-3E8880	723.29
	9T1388		P-UB-10	5-3/4	8-1/4	CTC-8T1558	665.65
	9T9356		P-UB-10	5-3/4	8-1/4	CTC-3E8880	723.29
TRACK ADJUSTER							
			TRK ADJ			CTC-FIG0405	108.68
<b>MODEL 302.5</b>							
BLADE							
	4AZ1-4947						
	1662835		P-U-10	45 mm	75 mm	CTC-1662835K	50.29
	4AZ4948-UP						
	2126335		P-U-10	45 mm	75 mm	CTC-2126335K	50.29
BOOM							
	4AZ1-329						
	1509211		P-U-10	45 mm	75 mm	CTC-1509211K	60.08
	4AZ330-4822						
	1794969		P-U-10	45 mm	75 mm	CTC-1794969K	60.08
	4AZ4823-UP						
	2126337		P-U-10	45 mm	75 mm	CTC-2126337K	54.83
BUCKET							
	4AZ1-4828						
	1513187		P-U-10	35 mm	65 mm	CTC-1513187K	39.41
	4AZ1-UP						
	2269959		P-U-10	35 mm	65 mm	CTC-2269959K	38.86
	4AZ4829-5653						
	2126328		P-U-10	35 mm	65 mm	CTC-2126328K	38.86
BUCKET TILT							
	4AZ1-UP						
	2443074		P-U-10	30 mm	60 mm	CTC-1608546	51.42
STICK							
	4AZ1-4828						
	1512460		P-U-10	40 mm	70 mm	CTC-1512460K	44.80
	4AZ1-UP						
	2374079		P-U-10	40 mm	70 mm	CTC-2374079K	43.71
	4AZ4829-5653						
	2126329		P-U-10	40 mm	70 mm	CTC-2126329K	43.71
	2373542		P-U-10	40 mm	70 mm	CTC-2373542K	43.71
SWING BOOM							
	4AZ1-4822						
	1511266		P-U-10	45 mm	75 mm	CTC-1511266K	50.98
	1724223		P-U-10	45 mm	75 mm	CTC-1724223K	50.29
	4AZ4823-UP						
	2126336		P-U-10	45 mm	75 mm	CTC-2126336K	50.29
<b>MODEL 302.5C</b>							
BOOM							
	GBB1-UP						
	2126337		P-U-10	45 mm	75 mm	CTC-2126337K	54.83
BUCKET							
	GBB1-UP						
	2269959		P-U-10	35 mm	65 mm	CTC-2269959K	38.86
LIFT							
	GBB1-UP						
	2309267		P-U-10	45 mm	85 mm	CTC-2309267K	80.28

CATERPILLAR®





## REPLACEMENT KITS FOR CATERPILLAR® EQUIPMENT

Excavators							
APPLICATION	CYL #	Misc-Parts, Instructions, etc.	CODE	ROD	BORE	KIT #	List \$
<b>MODEL 302.5C</b>							
STICK							
GBB1-UP							
2374079			P-U-10	40 mm	70 mm	CTC-2374079K	43.71
SWING BOOM							
GBB1-1897							
2126336			P-U-10	45 mm	75 mm	CTC-2126336K	50.29
GBB1898-UP							
2935360			P-U-10	45 mm	75 mm	CTC-2935360K	49.85
<b>MODEL 303 C CR</b>							
BLADE ANGLE							
BXT1-UP							
			P-U-10	35 mm	65 mm	CTC-2839122	42.83
BLADE RAISE LOWER							
BXT1-UP							
2666979			P-U-10	45 mm	80 mm	CTC-2788641	73.47
BOOM							
BXT1-UP							
2737033			P-U-10	45 mm	80 mm	CTC-2788641	73.47
2840420			P-U-10	45 mm	80 mm	CTC-2788641	73.47
2855034			P-U-10	50 mm	85 mm	CTC-2790639	86.44
BUCKET							
BXT1-UP							
2666973			P-U-10	40 mm	70 mm	CTC-2519845	70.43
2778672			P-U-10	40 mm	70 mm	CTC-2519845	70.43
STICK							
BXT1-UP							
2840863			P-U-10	45 mm	80 mm	CTC-2797940	78.40
TILTABLE BUCKET							
BXT1-UP							
2460192			P-UB-10	1-1/2	3	CTC-2460192K	36.51
2460192			Bushing	1-1/2		CTC-4T6780	9.22
<b>MODEL 303.5</b>							
BLADE							
AFW1-UP; DCH1-UP							
1636935			P-U-10	50 mm	90 mm	CTC-1636935K	118.30
BOOM							
AFW1-UP							
1637006			P-U-10	45 mm	80 mm	CTC-1637006K	105.93
BUCKET							
AFW1-UP; DCH1-UP							
1637008			P-U-10	40 mm	70 mm	CTC-1637008K	143.93
STICK							
AFW1-UP; DCH1-UP							
1636936			P-U-10	45 mm	75 mm	CTC-1636936K	152.57
SWING BOOM							
AFW1-UP; DCH1-UP							
1637007			P-U-10	45 mm	80 mm	CTC-1637007K	105.93
<b>MODEL 303.5C CR</b>							
BLADE ANGLE							
DMY1-UP							
2866384			P-U-10	35 mm	65 mm	CTC-2839122	42.83
BLADE RAISE LOWER							
DMY1-UP							
2666979			P-U-10	45 mm	80 mm	CTC-2788641	73.47
2666979			Link Pin Seal			CTC-1920638	8.53
2666979			Link Pin Seal			CTC-1920638	8.53

CATERPILLAR®



## REPLACEMENT KITS FOR CATERPILLAR® EQUIPMENT

<b>Excavators</b>							
APPLICATION	CYL #	Misc-Parts, Instructions, etc.	CODE	ROD	BORE	KIT #	List \$
<b>MODEL 303.5C CR</b>							
<b>BOOM</b>							
DMY1-UP							
2737030			P-U-10	50 mm	85 mm	CTC-2812321	75.89
2843369			P-U-10	50 mm	85 mm	CTC-2812321	75.89
2843369			Link Pin Seal			CTC-1920638	8.53
2843369			Link Pin Seal			CTC-1920638	8.53
<b>BUCKET</b>							
DMY1-UP							
2460192			P-UB-10	1-1/2	3	CTC-2460192K	36.51
2666971			P-U-10	45 mm	75 mm	CTC-2812322	69.86
2666971			Link Pin Seal			CTC-1920638	8.53
2666971			Link Pin Seal			CTC-1920638	8.53
2779900			P-U-10	45 mm	75 mm	CTC-2779900K	69.86
2779900			Link Pin Seal			CTC-1920638	8.53
2779900			Link Pin Seal			CTC-1920638	8.53
<b>STICK</b>							
DMY1-UP							
2840883			P-U-10	50 mm	80 mm	CTC-2812323	75.63
2840883			Link Pin Seal			CTC-1920638	8.53
2840883			Link Pin Seal			CTC-1920638	8.53
<b>SWING BOOM</b>							
DMY1-UP							
2843909			P-U-10	50 mm	85 mm	CTC-2790639	86.44
2843909			Link Pin Seal			CTC-1920638	8.53
2843909			Link Pin Seal			CTC-1920638	8.53
<b>MODEL 303CR</b>							
<b>BLADE</b>							
DMA1-UP							
1937859			P-U-10	45 mm	85 mm	CTC-1937859K	74.18
<b>BOOM</b>							
DMA1-UP							
1987021			P-U-10	50 mm	80 mm	CTC-1987021K	116.14
<b>BUCKET</b>							
DMA1-UP							
2037172			P-U-10	40 mm	65 mm	CTC-2037172K	45.53
2190541			P-U-10	40 mm	65 mm	CTC-2190541K	45.53
2390837			P-U-10	40 mm	65 mm	CTC-2390837K	45.50
<b>STICK</b>							
DMA1-UP							
1937852			P-U-10	45 mm	75 mm	CTC-1937852K	72.93
2763879			P-U-10	45 mm	75 mm	CTC-2763879K	72.93
<b>SWING BOOM</b>							
DMA1-UP							
1937855			P-U-10	45 mm	80 mm	CTC-1937855K	63.28
<b>TILT</b>							
DMA1-UP							
2460192			P-UB-10	1-1/2	3	CTC-2350354	34.36
<b>MODEL 304 C CR</b>							
<b>BLADE ANGLE</b>							
FPK1-UP							
2704714			P-U-10	35 mm	65 mm	CTC-2839122	42.83
<b>BLADE RAISE LOWER</b>							
FPK1-UP							
2937158			P-U-10	55 mm	90 mm	CTC-2937158K	76.95

**CATERPILLAR®**



## REPLACEMENT KITS FOR CATERPILLAR® EQUIPMENT

Excavators							
APPLICATION	CYL #	Misc-Parts, Instructions, etc.	CODE	ROD	BORE	KIT #	List \$
<b>MODEL 304 C CR</b>							
BOOM							
FPK1-UP							
	2666975		P-U-10	55 mm	90 mm	CTC-2666975K	76.95
	2709475		P-UB-14	55 mm	95 mm	CTC-2773395	96.93
	2828548		P-UB-14	55 mm	95 mm	CTC-2773395	96.93
BUCKET							
FPK1-UP							
	2666969		P-UB-14	45 mm	75 mm	CTC-2774167	139.80
STICK							
FPK1-UP							
	2828550		P-UB-14	50 mm	85 mm	CTC-2774140	81.74
TILTABLE BUCKET							
FPK1-UP							
	2460192		P-UB-10	1-1/2	3	CTC-2460192K	36.51
<b>MODEL 304.5</b>							
BLADE							
ANR1-UP; WAK1-UP							
	1636973		P-U-10	50 mm	100 mm	CTC-1934324	127.36
BOOM							
ANR1-UP; WAK1-UP							
	1636970		P-U-10	50 mm	85 mm	CTC-1934321	134.80
BUCKET							
ANR1-UP; WAK1-UP							
	1636972		P-U-10	45 mm	75 mm	CTC-1934323	72.88
STICK							
ANR1-UP; WAK1-UP							
	1708945		P-U-10	50 mm	80 mm	CTC-1934325	116.11
SWING BOOM							
ANR1-UP; WAK1-UP							
	1636971		P-U-10	50 mm	90 mm	CTC-1934322	89.08
<b>MODEL 304CR</b>							
BLADE							
NAD1-UP							
	2153747		P-U-10	55 mm	100 mm	CTC-2167247	134.69
BLADE ANGLE							
NAD1-UP							
	2704714		P-U-10	35 mm	65 mm	CTC-2839122	42.83
BOOM							
NAD1-UP							
	2099617		P-U-10	50 mm	85 mm	CTC-2167644	216.71
	2160991		P-U-10	55 mm	95 mm	CTC-2199066	160.72
BUCKET							
NAD1-UP							
	2180511		P-U-10	45 mm	70 mm	CTC-2168100	189.95
	2397706		P-U-10	45 mm	70 mm	CTC-2168100	189.95
STICK							
NAD1-UP							
	2081152		P-U-10	55 mm	85 mm	CTC-2171643	221.81
<b>MODEL 305 C CR</b>							
BLADE							
HWJ1-834							
	2666977		P-U-10	55 mm	90 mm	CTC-2666977K	76.95
HWJ1-UP							
	2937158		P-U-10	55 mm	90 mm	CTC-2937158K	76.95
BLADE ANGLE							
HWJ1-UP							
	2704714		P-U-10	35 mm	65 mm	CTC-2839122	42.83



## REPLACEMENT KITS FOR CATERPILLAR® EQUIPMENT

Excavators							
APPLICATION	CYL #	Misc-Parts, Instructions, etc.	CODE	ROD	BORE	KIT #	List \$
<b>MODEL 305 C CR</b>							
BOOM							
HWJ1-UP							
	2666975		P-U-10	55 mm	90 mm	CTC-2666975K	76.95
	2737025		P-U-10	55 mm	100 mm	CTC-2737025K	109.90
	2821535		P-U-10	55 mm	100 mm	CTC-2821535K	109.92
BUCKET							
HWJ1-UP							
	2666967		P-U-10	50 mm	80 mm	CTC-2666967K	99.73
STICK							
HWJ1-UP							
	2821537		P-U-10	55 mm	90 mm	CTC-2821537K	75.93
TILTABLE BUCKET							
HWJ1-UP							
	2460192		P-UB-10	1-1/2	3	CTC-2460192K	36.51
<b>MODEL 305CR</b>							
BLADE							
DGT1-UP; DSA244-UP							
	2153747		P-U-10	55 mm	100 mm	CTC-2167247	134.69
DSA1-243							
	1911962		P-U-10	55 mm	100 mm	CTC-1992402	88.93
BLADE ANGLE							
DGT1-UP							
	2704714		P-U-10	35 mm	65 mm	CTC-2839122	42.83
BOOM							
DGT1-UP; DSA1-UP							
	1911958		P-U-10	55 mm	100 mm	CTC-1989433	87.39
BUCKET							
DGT1-UP; DSA1-UP							
	2152232		P-U-10	45 mm	75 mm	CTC-1991149	69.90
STICK							
DGT1-UP; DSA1-UP							
	1911959		P-U-10	55 mm	85 mm	CTC-1990609	82.94
SWING BOOM							
DGT1-UP; DSA1-UP							
	1911961		P-U-10	50 mm	90 mm	CTC-1992097	96.48
<b>MODEL 307</b>							
BLADE LH							
	1076377		P-UB-15	50 mm	90 mm	CTC-0933045	327.93
	1148378		P-UB-15	50 mm	90 mm	CTC-0933045	327.93
BLADE RH							
	1076472		P-UB-15	50 mm	90 mm	CTC-0933045	327.93
	1148377		P-UB-15	50 mm	90 mm	CTC-0933045	327.93
BOOM							
	1038195		P-UB-14	75 mm	110 mm	CTC-1057255	272.11
	1057468		P-UB-14	55 mm	100 mm	CTC-1057480	211.26
	1239937		P-UB-14	55 mm	100 mm	CTC-1057480	211.26
BUCKET							
	1057238		P-UB-14	55 mm	80 mm	CTC-1057253	184.71
OFFSET							
	1057468		P-UB-14	55 mm	100 mm	CTC-1057480	211.26
	1239937		P-UB-14	55 mm	100 mm	CTC-1057480	211.26
STICK							
	1038320		P-UB-14	60 mm	90 mm	CTC-1038333	247.83
	1057437		P-UB-14	60 mm	90 mm	CTC-1038333	247.83
	1251494		P-UB-14	60 mm	90 mm	CTC-1038333	247.83

CATERPILLAR®



## REPLACEMENT KITS FOR CATERPILLAR® EQUIPMENT

Excavators							
APPLICATION	CYL #	Misc-Parts, Instructions, etc.	CODE	ROD	BORE	KIT #	List \$
<b>MODEL 307B</b>							
<b>BLADE</b>							
	1231627		P-UB-10	80 mm	120 mm	CTC-1697835	216.22
	1624835		P-UB-10	80 mm	120 mm	CTC-1697835	216.22
<b>BOOM</b>							
	1336759		P-UB-14	75 mm	110 mm	CTC-1697826	133.09
	1437980		P-UB-14	75 mm	110 mm	CTC-1697826	133.09
<b>BUCKET</b>							
	1057238		P-UB-14	55 mm	80 mm	CTC-1057253	184.71
<b>OFFSET</b>							
	1239937		P-UB-14	55 mm	100 mm	CTC-1057480	211.26
<b>STICK</b>							
	1038320		P-UB-14	60 mm	90 mm	CTC-1038333	247.83
	1475903		P-UB-14	60 mm	90 mm	CTC-1697827	206.73
	1505899		P-UB-14	60 mm	90 mm	CTC-1697827	206.73
<b>SWING</b>							
	1437981		P-UB-10	65 mm	100 mm	CTC-1697830	114.99
<b>MODEL 307C</b>							
<b>BLADE</b>							
			P-UB-10	80 mm	120 mm	CTC-1697835	216.22
<b>BCM1-UP; BNE1-UP</b>							
	1799671		P-UB-10	80 mm	120 mm	CTC-1697835	216.22
	1799671		Bushing	80 mm		CTC-1140755	32.83
	2358256		P-UB-10	80 mm	120 mm	CTC-1697835	216.22
	2358256		Bushing	80 mm		CTC-1140755	32.83
<b>BOOM</b>							
<b>BCM1-UP</b>							
	1659273		P-UB-14	75 mm	110 mm	CTC-1697826	133.09
	1659273		Bushing	75 mm		CTC-1140750	29.93
	1935230		P-UB-14	75 mm	110 mm	CTC-1697826	133.09
	1935230		Bushing	75 mm		CTC-1140750	29.93
	2357905		P-UB-14	75 mm	110 mm	CTC-1697826	133.09
	2357905		Bushing	75 mm		CTC-1140750	29.93
	2358249		P-UB-14	75 mm	110 mm	CTC-1697826	133.09
	2358249		Bushing	75 mm		CTC-1140750	29.93
	2358264		P-UB-14	55 mm	100 mm	CTC-1697829	142.79
	3044904		P-UB-14	75 mm	110 mm	CTC-1697826	133.09
	3044904		Bushing	75 mm		CTC-1140750	29.93
	3044909		P-UB-14	75 mm	110 mm	CTC-1697826	133.09
	3044909		Bushing	75 mm		CTC-1140750	29.93
<b>BNE1-UP</b>							
	2357921		P-UB-14	75 mm	110 mm	CTC-1697826	133.09
	2357921		Bushing	75 mm		CTC-1140750	29.93
	2557799	VARIABLE ADJUSTABLE BOOM	P-UB-14	55 mm	100 mm	CTC-1697829	142.79
	2557801	VARIABLE ADJUSTABLE BOOM	P-UB-14	75 mm	110 mm	CTC-1697826	133.09
	2557801	VARIABLE ADJUSTABLE BOOM	Bushing	75 mm		CTC-1140750	29.93
	3044912		P-UB-14	75 mm	110 mm	CTC-1697826	133.09
	3044912		Bushing	75 mm		CTC-1140750	29.93
	3044913	VARIABLE ADJUSTABLE BOOM	P-UB-14	75 mm	110 mm	CTC-1697826	133.09
	3044913	VARIABLE ADJUSTABLE BOOM	Bushing	75 mm		CTC-1140750	29.93
	3044915	VARIABLE ADJUSTABLE BOOM	P-UB-14	55 mm	100 mm	CTC-1697829	142.79
<b>BUCKET</b>							
<b>BCM1-UP; BNE1-UP</b>							
	1659279		P-UB-14	55 mm	80 mm	CTC-1697828	150.03
	3044908		P-UB-14	55 mm	80 mm	CTC-1697828	150.03

**CATERPILLAR®**



## REPLACEMENT KITS FOR CATERPILLAR® EQUIPMENT

<b>Excavators</b>							
APPLICATION	CYL #	Misc-Parts, Instructions, etc.	CODE	ROD	BORE	KIT #	List \$
<b>MODEL 307C</b>							
<b>CAB RISER</b>							
BCM1-UP; BNE1-UP							
2358287			P-UB-14	60 mm	90 mm	CTC-1697827	206.73
2358287			Bushing	60 mm		CTC-1140751	23.38
<b>OFFSET</b>							
BCM1-UP							
1799711			P-UB-14	55 mm	100 mm	CTC-1697829	142.79
3044906			P-UB-14	55 mm	100 mm	CTC-1697829	142.79
<b>STICK</b>							
BCM1-UP							
1799708			P-UB-14	60 mm	90 mm	CTC-1697827	206.73
1799708			Bushing	60 mm		CTC-1140751	23.38
2042718			P-UB-14	60 mm	90 mm	CTC-2042718K	153.88
2042718			Bushing	60 mm		CTC-1140751	23.38
2358271			P-UB-14	60 mm	90 mm	CTC-1697827	206.73
2358271			Bushing	60 mm		CTC-1140751	23.38
3044907			P-UB-14	60 mm	90 mm	CTC-1697827	206.73
3044907			Bushing	60 mm		CTC-1140751	23.38
BCM1-UP; BNE1-UP							
1659276			P-UB-14	60 mm	90 mm	CTC-1659276K	119.68
1659276			Bushing	60 mm		CTC-1140751	23.38
2357913			P-UB-14	60 mm	90 mm	CTC-1697827	206.73
2357913			Bushing	60 mm		CTC-1140751	23.38
3044905			P-UB-14	60 mm	90 mm	CTC-1697827	206.73
3044905			Bushing	60 mm		CTC-1140751	23.38
3044910			P-UB-14	60 mm	90 mm	CTC-1697827	206.73
3044910			Bushing	60 mm		CTC-1140751	23.38
<b>SWING</b>							
BNE1-UP							
1772556			P-UB-14	75 mm	110 mm	CTC-1697826	133.09
1772556			Bushing	75 mm		CTC-1140750	29.93
<b>SWING BOOM</b>							
BNE1-463							
1772474			P-UB-14	60 mm	90 mm	CTC-1697827	206.73
1772474			Bushing	60 mm		CTC-1140751	23.38
BNE1630-UP							
3044911			P-UB-14	60 mm	90 mm	CTC-1697827	206.73
3044911			Bushing	60 mm		CTC-1140751	23.38
3044911			Bushing	60 mm		CTC-1140751	23.38
BNE464-UP							
2375468			P-UB-14	60 mm	90 mm	CTC-1697827	206.73
2375468			Bushing	60 mm		CTC-1140751	23.38
<b>MODEL 308B</b>							
<b>BLADE</b>							
1231627			P-UB-10	80 mm	120 mm	CTC-1697835	216.22
1624835			P-UB-10	80 mm	120 mm	CTC-1697835	216.22
<b>BUCKET</b>							
1057238			P-UB-14	55 mm	80 mm	CTC-1057253	184.71
<b>STICK</b>							
1038320			P-UB-14	60 mm	90 mm	CTC-1038333	247.83
<b>MODEL 308C CR</b>							
<b>BLADE</b>							
KCX1-UP							
1799671			P-UB-10	80 mm	120 mm	CTC-1697835	216.22
1799671			Bushing	80 mm		CTC-1140755	32.83
2358256			P-UB-10	80 mm	120 mm	CTC-1697835	216.22
2358256			Bushing	80 mm		CTC-1140755	32.83

**CATERPILLAR®**



## REPLACEMENT KITS FOR CATERPILLAR® EQUIPMENT

Excavators							
APPLICATION	CYL #	Misc-Parts, Instructions, etc.	CODE	ROD	BORE	KIT #	List \$
<b>MODEL 308C CR</b>							
BOOM							
KCX1-UP							
1799645			P-UB-14	75 mm	110 mm	CTC-1697826	133.09
1799645			Bushing	75 mm		CTC-1140750	29.93
1799651			P-UB-10	55 mm	100 mm	CTC-2003242	141.17
1799655			P-UB-10	75 mm	120 mm	CTC-2003239	83.47
1799655			Bushing	75 mm		CTC-1140750	29.93
1799658			P-UB-10	70 mm	100 mm	CTC-2003240	96.30
1799658			Bushing	70 mm		CTC-1140753	28.52
2159893			P-UB-14	75 mm	110 mm	CTC-1697826	133.09
2159893			Bushing	75 mm		CTC-1140750	29.93
2357834			P-UB-10	55 mm	100 mm	CTC-2003242	141.17
2357845			P-UB-10	75 mm	120 mm	CTC-2003239	83.47
2357845			Bushing	75 mm		CTC-1140750	29.93
2357862			P-UB-10	70 mm	100 mm	CTC-2003240	96.30
2357862			Bushing	70 mm		CTC-1140753	28.52
3044900			P-UB-14	75 mm	110 mm	CTC-3044900K	128.00
3044900			Bushing	75 mm		CTC-1140750	29.93
BUCKET							
KCX1-UP							
1659279			P-UB-14	55 mm	80 mm	CTC-1697828	150.03
3044908			P-UB-14	55 mm	80 mm	CTC-1697828	150.03
STICK							
KCX1-UP							
2042718			P-UB-14	60 mm	90 mm	CTC-2042718K	153.88
2042718			Bushing	60 mm		CTC-1140751	23.38
2159896			P-UB-14	60 mm	90 mm	CTC-2159896K	153.88
2159896			Bushing	60 mm		CTC-1140751	23.38
3044910			P-UB-14	60 mm	90 mm	CTC-1697827	206.73
3044910			Bushing	60 mm		CTC-1140751	23.38
<b>MODEL 311</b>							
BOOM							
1251548			P-UB-10	70 mm	100 mm	CTC-616858	274.20
418841			P-UB-10	70 mm	100 mm	CTC-616858	274.20
BUCKET							
1251547			P-UB-10	65 mm	100 mm	CTC-418914	204.39
1346987			P-UB-10	65 mm	100 mm	CTC-1764935	221.28
418840			P-UB-10	65 mm	100 mm	CTC-418914	204.39
STICK							
1251549			P-UB-10	75 mm	110 mm	CTC-418913	290.99
418842			P-UB-10	75 mm	110 mm	CTC-418913	290.99
<b>MODEL 311B</b>							
BLADE LH							
1298009			P-UB-10	80 mm	120 mm	CTC-1697835	216.22
BLADE RH							
1298010			P-UB-10	80 mm	120 mm	CTC-1697835	216.22
BOOM							
1211395			P-UB-10	70 mm	100 mm	CTC-1211405	273.28
BUCKET							
1195447			P-UB-10	65 mm	100 mm	CTC-1195457	214.51
1438158			P-UB-10	65 mm	100 mm	CTC-1697839	219.03
STICK							
1211406			P-UB-10	75 mm	110 mm	CTC-1195435	295.44
1438160			P-UB-10	75 mm	110 mm	CTC-1697837	259.73

CATERPILLAR®





## REPLACEMENT KITS FOR CATERPILLAR® EQUIPMENT

Excavators							
APPLICATION	CYL #	Misc-Parts, Instructions, etc.	CODE	ROD	BORE	KIT #	List \$
<b>MODEL 311C U</b>							
BLADE LH							
CKE1-UP; PAD1-UP							
1709809			P-UB-10	80 mm	120 mm	CTC-1709946	347.28
BLADE RH							
CKE1-UP; PAD1-UP							
1709810			P-UB-10	80 mm	120 mm	CTC-1709946	347.28
BOOM							
CKE1-UP; PAD1-UP							
1709806				70 mm	100 mm	CTC-1709929	310.85
BUCKET							
CKE1-UP							
1709809			P-UB-10	65 mm	100 mm	CTC-1709941	129.73
2959396			P-UB-10	65 mm	100 mm	CTC-1709941	129.73
CKE1-UP; PAD1-UP							
2487855			P-UB-10	65 mm	100 mm	CTC-1709941	129.73
2836118			P-UB-10	65 mm	100 mm	CTC-1709941	129.73
COUPLER							
CKE1-UP							
1847487	Quick Coupler		I-U-10	1-3/4	63 mm	CTC-1728486	66.64
2734147			I-U-10	1-3/4	63 mm	CTC-3265237	66.64
STICK							
CKE1-UP; PAD1-UP							
1709807			P-UB-10	75 mm	110 mm	CTC-1709937	155.78
<b>MODEL 312</b>							
BOOM							
1148519			P-UB-10	75 mm	110 mm	CTC-1148526	239.80
1251545			P-UB-10	75 mm	110 mm	CTC-418913	290.99
418838			P-UB-10	75 mm	110 mm	CTC-418913	290.99
BUCKET							
1195447			P-UB-10	65 mm	100 mm	CTC-1195457	214.51
1251547			P-UB-10	65 mm	100 mm	CTC-418914	204.39
1346987			P-UB-10	65 mm	100 mm	CTC-1764935	221.28
418840			P-UB-10	65 mm	100 mm	CTC-418914	204.39
OFFSET							
1239906			P-UB-10	70 mm	130 mm	CTC-1697843	293.89
STICK							
1211406			P-UB-10	75 mm	110 mm	CTC-1195435	295.44
1239943			P-UB-10	80 mm	120 mm	CTC-1148290	202.92
1251546			P-UB-10	80 mm	120 mm	CTC-513047	244.85
1251940			P-UB-10	80 mm	120 mm	CTC-1148290	202.92
418839			P-UB-10	80 mm	120 mm	CTC-513047	244.85
<b>MODEL 312B, 312BL</b>							
BLADE LH							
1298009			P-UB-10	80 mm	120 mm	CTC-1697835	216.22
BLADE RH							
1298010			P-UB-10	80 mm	120 mm	CTC-1697835	216.22
BOOM							
1195425			P-UB-10	75 mm	110 mm	CTC-1195435	295.44
1438156			P-UB-10	75 mm	110 mm	CTC-1697837	259.73
BUCKET							
1195447			P-UB-10	65 mm	100 mm	CTC-1195457	214.51
1438158			P-UB-10	65 mm	100 mm	CTC-1697839	219.03
STICK							
1195436			P-UB-10	80 mm	120 mm	CTC-1195446	269.53
1438157			P-UB-10	80 mm	120 mm	CTC-1697838	271.32

CATERPILLAR®



## REPLACEMENT KITS FOR CATERPILLAR® EQUIPMENT

Excavators							
APPLICATION	CYL #	Misc-Parts, Instructions, etc.	CODE	ROD	BORE	KIT #	List \$
<b>MODEL 312C, 312CL</b>							
BOOM							
			P-UB-10	75 mm	110 mm	CTC-1709937	155.78
			Bushing	75 mm		CTC-1140750	29.93
BUCKET							
			P-UB-10	65 mm	100 mm	CTC-1709941	129.73
			Bushing	65 mm		CTC-1140754	24.80
STICK							
			P-UB-10	80 mm	120 mm	CTC-1709999	192.56
			Bushing	80 mm		CTC-1140755	32.83
<b>MODEL 313B</b>							
BLADE LH							
	1298009		P-UB-10	80 mm	120 mm	CTC-1697835	216.22
BLADE RH							
	1298010		P-UB-10	80 mm	120 mm	CTC-1697835	216.22
BOOM							
	1624758		P-UB-10	75 mm	110 mm	CTC-1697837	259.73
BUCKET							
	1346987		P-UB-10	65 mm	100 mm	CTC-1764935	221.28
	1438158		P-UB-10	65 mm	100 mm	CTC-1697839	219.03
OFFSET							
	1239906		P-UB-10	70 mm	130 mm	CTC-1697843	293.89
STICK							
	1195436		P-UB-10	80 mm	120 mm	CTC-1195446	269.53
	1211406		P-UB-10	75 mm	110 mm	CTC-1195435	295.44
	1438157		P-UB-10	80 mm	120 mm	CTC-1697838	271.32
	1438160		P-UB-10	75 mm	110 mm	CTC-1697837	259.73
<b>MODEL 314C LCR</b>							
BLADE LH							
	KJA1-UP; PCA1-UP						
	1709809		P-UB-10	80 mm	120 mm	CTC-1709946	347.28
	1709809		Bushing	80 mm		CTC-1140755	32.83
BLADE RH							
	KJA1-UP; PCA1-UP						
	1709810		P-UB-10	80 mm	120 mm	CTC-1709946	347.28
	1709810		Bushing	80 mm		CTC-1140755	32.83
BOOM							
	KJA1-UP; PCA1-UP						
	1948228		P-UB-10	75 mm	110 mm	CTC-1709937	155.78
	1948228		Bushing	75 mm		CTC-1140750	29.93
	1948239		P-UB-10	75 mm	110 mm	CTC-1709937	155.78
	1948239		Bushing	75 mm		CTC-1140750	29.93
BUCKET							
	KJA1-UP; PCA1-UP						
	1709808		P-UB-10	65 mm	100 mm	CTC-1709941	129.73
	1709808		Bushing	65 mm		CTC-1140754	24.80
	2487855		P-UB-10	65 mm	100 mm	CTC-1709941	129.73
	2487855		Bushing	65 mm		CTC-1140754	24.80
	2836118		P-UB-10	65 mm	100 mm	CTC-1709941	129.73
	2836118		Bushing	65 mm		CTC-1140754	24.80
	2959396		P-UB-10	65 mm	100 mm	CTC-1709941	129.73
	2959396		Bushing	65 mm		CTC-1140754	24.80
OFFSET							
	KJA1-UP; PCA1-UP						
	2042765		P-UB-10	75 mm	130 mm	CTC-2003361	197.97
	2042765		Bushing	75 mm		CTC-1140750	29.93

CATERPILLAR®



## REPLACEMENT KITS FOR CATERPILLAR® EQUIPMENT

<b>Excavators</b>							
APPLICATION	CYL #	Misc-Parts, Instructions, etc.	CODE	ROD	BORE	KIT #	List \$
<b>MODEL 314C LCR</b>							
QUICK COUPLER							
KJA1-UP; PCA1-UP							
	1847487		I-U-10	1-3/4	63 mm	CTC-1728486	66.64
	2734147		I-U-10	1-3/4	63 mm	CTC-3265237	66.64
STICK							
KJA1-UP; PCA1-UP							
	1948250		P-UB-10	80 mm	120 mm	CTC-1709999	192.56
	1948250		Bushing	80 mm		CTC-1140755	32.83
	1948312		P-UB-10	80 mm	120 mm	CTC-1709999	192.56
	1948312		Bushing	80 mm		CTC-1140755	32.83
	2512894		P-UB-10	80 mm	120 mm	CTC-1709999	192.56
	2512894		Bushing	80 mm		CTC-1140755	32.83
	3350003		P-UB-10	80 mm	120 mm	CTC-3350007	145.42
	3350003		Bushing	80 mm		CTC-1140755	32.83
<b>MODEL 315</b>							
BOOM							
	1057336		P-UB-10	80 mm	110 mm	CTC-1057359	245.15
	1276046		P-UB-10	80 mm	110 mm	CTC-1057359	245.15
BUCKET							
	1057381		P-UB-10	70 mm	100 mm	CTC-1057397	202.76
	1076640		P-UB-10	80 mm	110 mm	CTC-1057359	245.15
	1276056		P-UB-10	70 mm	100 mm	CTC-1057397	202.76
	1276060		P-UB-10	80 mm	110 mm	CTC-1057359	245.15
STICK							
	1057362		P-UB-10	85 mm	120 mm	CTC-1057379	259.18
	1276051		P-UB-10	85 mm	120 mm	CTC-1057379	259.18
	1624672		P-UB-10	85 mm	120 mm	CTC-1624676	103.98
<b>MODEL 315B</b>							
BOOM							
1SW1-UP; 3AW1-UP; 7RZ1-UP							
	1559251		P-UB-10	80 mm	110 mm	CTC-1659420	139.06
	1559251		Bushing	80 mm		CTC-1140755	32.83
BUCKET							
1SW1-UP; 3AW1-UP; 7RZ1-UP							
	1733490		P-UB-10	70 mm	100 mm	CTC-1799638	97.72
	1733490		Bushing	70 mm		CTC-1140753	28.52
STICK							
1SW1-UP; 3AW1-UP; 7RZ1-UP							
	1559253		P-UB-10	85 mm	120 mm	CTC-1659418	139.80
	1559253		Bushing	85 mm		CTC-1140756	35.81
<b>MODEL 315B L</b>							
BOOM							
1SW1-UP; 3AW1-UP; 5SW1-UP; 7RZ1-UP							
	1559251		P-UB-10	80 mm	110 mm	CTC-1659420	139.06
	1559251		Bushing	80 mm		CTC-1140755	32.83
5SW1-UP							
	1336630		P-UB-10	80 mm	110 mm	CTC-1336646	247.79
	1336630		Bushing	80 mm		CTC-1140755	32.83
	1847660		P-UB-10	85 mm	140 mm	CTC-1847660K	135.48
	1847660		Bushing	85 mm		CTC-1140756	35.81
BUCKET							
1SW1-UP; 3AW1-UP; 7RZ1-UP							
	1733490		P-UB-10	70 mm	100 mm	CTC-1799638	97.72
	1733490		Bushing	70 mm		CTC-1140753	28.52

**CATERPILLAR®**



## REPLACEMENT KITS FOR CATERPILLAR® EQUIPMENT

Excavators							
APPLICATION	CYL #	Misc-Parts, Instructions, etc.	CODE	ROD	BORE	KIT #	List \$
<b>MODEL 315B L</b>							
BUCKET							
5SW1-UP							
1336636			P-UB-10	70 mm	100 mm	CTC-1336691	215.11
1336636			Bushing	70 mm		CTC-1140753	28.52
1336639			P-UB-10	80 mm	110 mm	CTC-1336646	247.79
1336639			Bushing	80 mm		CTC-1140755	32.83
1559255			P-UB-10	70 mm	100 mm	CTC-1709827	109.67
1559255			Bushing	70 mm		CTC-1140753	28.52
1588923			P-UB-10	80 mm	110 mm	CTC-1659420	139.06
1588923			Bushing	80 mm		CTC-1140755	32.83
STICK							
1SW1-UP; 3AW1-UP; 5SW1-UP; 7RZ1-UP							
1559253			P-UB-10	85 mm	120 mm	CTC-1659418	139.80
1559253			Bushing	85 mm		CTC-1140756	35.81
5SW1-UP							
1336633			P-UB-10	85 mm	120 mm	CTC-1184131	249.86
1336633			Bushing	85 mm		CTC-1140756	35.81
<b>MODEL 315C</b>							
BOOM							
AKE1-UP; CFB1-UP; CFT1-UP; CJC1-UP							
1733482			P-UB-10	80 mm	110 mm	CTC-1799625	251.75
1733482			Bushing	80 mm		CTC-1140755	32.83
BUCKET							
AKE1-UP; CFB1-UP; CFT1-UP; CJC1-UP							
1733490			P-UB-10	70 mm	100 mm	CTC-1799638	97.72
1733490			Bushing	70 mm		CTC-1140753	28.52
1733493			P-UB-10	80 mm	110 mm	CTC-1799625	251.75
1733493			Bushing	80 mm		CTC-1140755	32.83
2836126			P-UB-10	70 mm	100 mm	CTC-1799638	97.72
2836126			Bushing	70 mm		CTC-1140753	28.52
2836128			P-UB-10	80 mm	110 mm	CTC-1799625	251.75
2836128			Bushing	80 mm		CTC-1140755	32.83
STICK							
AKE1-UP; CFB1-UP; CFT1-UP; CJC1-UP							
1733486			P-UB-10	85 mm	120 mm	CTC-1799634	139.80
1733486			Bushing	85 mm		CTC-1140756	35.81
<b>MODEL 315C L</b>							
BOOM							
AKE1-UP; ANF1-UP; CFB1-UP; CFT1-UP; CJC1-UP							
1733482			P-UB-10	80 mm	110 mm	CTC-1799625	251.75
1733482			Bushing	80 mm		CTC-1140755	32.83
ANF1-UP							
1559251			P-UB-10	80 mm	110 mm	CTC-1659420	139.06
1559251			Bushing	80 mm		CTC-1140755	32.83
1847660			P-UB-10	85 mm	140 mm	CTC-1847660K	135.48
1847660			Bushing	85 mm		CTC-1140756	35.81
BUCKET							
AKE1-UP; ANF1-UP; CFB1-UP; CFT1-UP; CJC1-UP							
1733490			P-UB-10	70 mm	100 mm	CTC-1799638	97.72
1733490			Bushing	70 mm		CTC-1140753	28.52
1733493			P-UB-10	80 mm	110 mm	CTC-1799625	251.75
1733493			Bushing	80 mm		CTC-1140755	32.83
2836126			P-UB-10	70 mm	100 mm	CTC-1799638	97.72
2836126			Bushing	70 mm		CTC-1140753	28.52
AKE1-UP; CFB1-UP; CFT1-UP; CJC1-UP							
2836128			P-UB-10	80 mm	110 mm	CTC-1799625	251.75
2836128			Bushing	80 mm		CTC-1140755	32.83

CATERPILLAR®



## REPLACEMENT KITS FOR CATERPILLAR® EQUIPMENT

Excavators							
APPLICATION	CYL #	Misc-Parts, Instructions, etc.	CODE	ROD	BORE	KIT #	List \$
<b>MODEL 315C L</b>							
BUCKET							
ANF1-UP							
	2836128		P-UB-10	80 mm	110 mm	CTC-1799625	251.75
	2836128		Bushing	80 mm		CTC-1140755	32.83
STICK							
AKE1-UP; CFB1-UP; CFT1-UP; CJC1-UP							
	1733486		P-UB-10	85 mm	120 mm	CTC-1799634	139.80
	1733486		Bushing	85 mm		CTC-1140756	35.81
ANF1-UP							
	1559253		P-UB-10	85 mm	120 mm	CTC-1659418	139.80
	1559253		Bushing	85 mm		CTC-1140756	35.81
	2248528		P-UB-10	85 mm	120 mm	CTC-1659418	139.80
	2248528		Bushing	85 mm		CTC-1140756	35.81
<b>MODEL 315D L</b>							
BOOM							
BZN1-UP; CJN1-UP; JGS1-UP; JHA1-UP; KBD1-UP; NCM1-UP							
	2590840		P-UB-10	80 mm	110 mm	CTC-2667861	137.27
BZN1-UP; CJN1-UP; JGS1-UP; NCM1-UP; TLE1-UP							
	2898093		P-UB-10	80 mm	110 mm	CTC-2667861	137.27
NCM1-UP; TLE1-UP							
	1847660	Variable Adj Boom	P-UB-10	85 mm	140 mm	CTC-1847660K	135.48
BUCKET							
BZN1-UP; CJN1-UP; JGS1-UP							
	2818979		P-UB-10	70 mm	100 mm	CTC-1799638	97.72
	3021734		P-UB-10	80 mm	110 mm	CTC-1799625	251.75
BZN1-UP; CJN1-UP; JGS1-UP; JHA1-UP; KBD1-UP							
	3228747		P-UB-10	80 mm	110 mm	CTC-1799625	251.75
BZN1-UP; JGS1-UP; KBD1-UP							
	3421892		P-UB-10	80 mm	110 mm	CTC-1799625	251.75
CJN1-UP							
	2590916		P-UB-10	80 mm	110 mm	CTC-1799625	251.75
CJN1-UP; JGS1-UP; NCM1-UP; TLE1-UP							
	3349944		P-UB-10	80 mm	110 mm	CTC-1799625	251.75
CJN1-UP; KBD1-UP							
	2590846		P-UB-10	70 mm	100 mm	CTC-1799638	97.72
CJN1-UP; NCM1-UP							
	2898121		P-UB-10	80 mm	110 mm	CTC-1799625	251.75
CJN1-UP; NCM1-UP; TLE1-UP							
	2898113		P-UB-10	70 mm	100 mm	CTC-1799638	97.72
COUPLER							
BZN1-UP; CJN1-UP; JGS1-UP; KBD1-UP; NCM1-UP; TLE1-UP							
	2569795		I-U-10	50 mm	70 mm	CTC-1728487	54.50
BZN1-UP; JGS1-UP							
	3052017		P-U-10,12	1-3/4	3	CTC-3465609	39.06
NCM1-UP; TLE1-UP							
	1690329		I-U-5	40 mm	60 mm	CTC-2027897	41.35
STICK							
BZN1-UP; CJN1-UP; JGS1-UP; JHA1-UP; KBD1-UP							
	2590843		P-UB-10	85 mm	120 mm	CTC-2667874	123.44
BZN1-UP; CJN1-UP; JGS1-UP; NCM1-UP; TLE1-UP							
	3228746		P-UB-10	85 mm	120 mm	CTC-2667874	123.44
CJN1-UP							
	2898103		P-UB-10	85 mm	120 mm	CTC-2667874	123.44
NCM1-UP							
	2884014		P-UB-10	85 mm	120 mm	CTC-2667874	123.44

CATERPILLAR®



## REPLACEMENT KITS FOR CATERPILLAR® EQUIPMENT

<b>Excavators</b>							
APPLICATION	CYL #	Misc-Parts, Instructions, etc.	CODE	ROD	BORE	KIT #	List \$
<b>MODEL 315L</b>							
BOOM							
	1057336		P-UB-10	80 mm	110 mm	CTC-1057359	245.15
BUCKET							
	1057381		P-UB-10	70 mm	100 mm	CTC-1057397	202.76
	1076640		P-UB-10	80 mm	110 mm	CTC-1057359	245.15
STICK							
	1057362		P-UB-10	85 mm	120 mm	CTC-1057379	259.18
<b>MODEL 317</b>							
BOOM							
	1057336		P-UB-10	80 mm	110 mm	CTC-1057359	245.15
	1276046		P-UB-10	80 mm	110 mm	CTC-1057359	245.15
BUCKET							
	1057381		P-UB-10	70 mm	100 mm	CTC-1057397	202.76
	1076640		P-UB-10	80 mm	110 mm	CTC-1057359	245.15
	1276056		P-UB-10	70 mm	100 mm	CTC-1057397	202.76
	1276060		P-UB-10	80 mm	110 mm	CTC-1057359	245.15
STICK							
	1057362		P-UB-10	85 mm	120 mm	CTC-1057379	259.18
	1276051		P-UB-10	85 mm	120 mm	CTC-1057379	259.18
	1624672		P-UB-10	85 mm	120 mm	CTC-1624676	103.98
<b>MODEL 317B, 317BL</b>							
BOOM							
	1336630	Piston - C 1276047	P-UB-10	80 mm	110 mm	CTC-1336646	247.79
	1336630		Bushing	80 mm		CTC-1140755	32.83
	1559251		P-UB-10	80 mm	110 mm	CTC-1659420	139.06
BUCKET							
	1336636	Piston - C 1336687	P-UB-10	70 mm	100 mm	CTC-1336691	215.11
	1336636		Bushing	70 mm		CTC-1140753	28.52
	1559255		P-UB-10	70 mm	100 mm	CTC-1709827	109.67
	5SW						
	1336639		P-UB-10	80 mm	110 mm	CTC-1336646	247.79
STICK							
	1336633	Piston - C 1276052	P-UB-10	85 mm	120 mm	CTC-1184131	249.86
	1336633		Bushing	85 mm		CTC-1140756	35.81
UNSPECIFIED APPLICATION							
	1588923		P-UB-10	80 mm	110 mm	CTC-1659420	139.06
<b>MODEL 317N</b>							
BOOM							
	1057336		P-UB-10	80 mm	110 mm	CTC-1057359	245.15
BUCKET							
	1057381		P-UB-10	70 mm	100 mm	CTC-1057397	202.76
	1076640		P-UB-10	80 mm	110 mm	CTC-1057359	245.15
STICK							
	1057362		P-UB-10	85 mm	120 mm	CTC-1057379	259.18
<b>MODEL 318B, 318BL</b>							
BOOM							
	1475755		P-UB-10	85 mm	120 mm	CTC-1373763	369.78
BUCKET							
	1183967		P-UB-10	85 mm	120 mm	CTC-1261947	346.12
	1184134		P-UB-10	85 mm	120 mm	CTC-1184131	249.86
	1475763		P-UB-10	80 mm	110 mm	CTC-1659420	139.06
STICK							
	1475760		P-UB-10	95 mm	130 mm	CTC-1659419	226.10

CATERPILLAR®



## REPLACEMENT KITS FOR CATERPILLAR® EQUIPMENT

Excavators							
APPLICATION	CYL #	Misc-Parts, Instructions, etc.	CODE	ROD	BORE	KIT #	List \$
<b>MODEL 318C</b>							
BOOM							
FAA1-UP; BTG1-UP; DAH1-UP							
1842614			P-UB-10	95 mm	160 mm	CTC-2521191	195.29
1948407			P-UB-10	85 mm	120 mm	CTC-1799634	139.80
BUCKET							
BTG1-UP; DAH1-UP							
2836132			P-UB-10	85 mm	120 mm	CTC-2366368	109.57
BTG475-UP; DAH1136-UP							
2836130			P-UB-10	80 mm	110 mm	CTC-1799625	251.75
FAA1-1135; BTG1-474; DAH1-UP							
1948413			P-UB-10	80 mm	110 mm	CTC-1799625	251.75
FAA1-UP; BTG1-UP; DAH1-UP							
1589061			P-U-10	85 mm	120 mm	CTC-2366389	109.57
COUPLER							
FAA1-UP; BTG1-UP; DAH1-UP							
1690329			I-U-5	40 mm	60 mm	CTC-2027897	41.35
STICK							
FAA1-UP; BTG1-UP; DAH1-UP							
1948410			P-UB-10	95 mm	130 mm	CTC-2159984	108.57
<b>MODEL 318C L</b>							
BOOM							
GPA1-UP; MDY1-UP							
1948416			P-UB-10	85 mm	120 mm	CTC-2478998	162.84
BUCKET							
GPA1-UP; MDY1-UP							
2003220			P-UB-10	80 mm	110 mm	CTC-2478995	146.23
2043689			P-UB-10	85 mm	120 mm	CTC-2479001	148.20
COUPLER							
GPA1-UP; MDY1-UP							
1728402			I-U-10	50 mm	70 mm	CTC-1728487	54.50
STICK							
GPA1-UP; MDY1-UP							
1949418			P-UB-10	95 mm	130 mm	CTC-2590630	167.76
<b>MODEL 318C LN</b>							
BOOM							
GPA1-UP; MDY1-UP							
1948416			P-UB-10	85 mm	120 mm	CTC-2478998	162.84
BUCKET							
GPA1-UP; MDY1-UP							
2003220			P-UB-10	80 mm	110 mm	CTC-2478995	146.23
2043689			P-UB-10	85 mm	120 mm	CTC-2479001	148.20
COUPLER							
GPA1-UP; MDY1-UP							
1728402			I-U-10	50 mm	70 mm	CTC-1728487	54.50
STICK							
GPA1-UP; MDY1-UP							
1949418			P-UB-10	95 mm	130 mm	CTC-2590630	167.76
<b>MODEL 320</b>							
BOOM							
0875491			P-UB-10	85 mm	120 mm	CTC-4I3665	313.01
0875496			P-UB-10	85 mm	120 mm	CTC-0875394	258.77
0875496			P-UB-10	85 mm	120 mm	CTC-1184131	249.86
1069596			P-UB-10	95 mm	160 mm	CTC-6C6091	336.81
BOOM VA							
6C6085			P-UB-10	95 mm	160 mm	CTC-6C6091	336.81

**CATERPILLAR®**





## REPLACEMENT KITS FOR CATERPILLAR® EQUIPMENT

Excavators							
APPLICATION	CYL #	Misc-Parts, Instructions, etc.	CODE	ROD	BORE	KIT #	List \$
<b>MODEL 320</b>							
BUCKET							
	0874899		P-UB-10	85 mm	120 mm	CTC-1186023	266.33
	0875633		P-UB-10	85 mm	120 mm	CTC-0875394	258.77
	0875633		P-UB-10	85 mm	120 mm	CTC-1184131	249.86
	1185931		P-UB-10	85 mm	120 mm	CTC-1186023	266.33
	1251547		P-UB-10	65 mm	100 mm	CTC-418914	204.39
	1346987		P-UB-10	65 mm	100 mm	CTC-1764935	221.28
	417652		P-UB-10	65 mm	100 mm	CTC-417664	204.47
	418840		P-UB-10	65 mm	100 mm	CTC-418914	204.39
	717291		P-UB-10	85 mm	130 mm	CTC-7Y5145	267.26
	7Y5100		P-UB-10	85 mm	130 mm	CTC-7Y5145	267.26
STICK							
	0875422		P-UB-10	100 mm	140 mm	CTC-0875387	341.66
	0875493		P-UB-10	100 mm	140 mm	CTC-1270630	340.15
	0876638		P-UB-10	100 mm	140 mm	CTC-0875387	341.66
	7Y4650		P-UB-10	105 mm	150 mm	CTC-1163612	301.76
UNSPECIFIED APPLICATION							
	0874898		P-UB-10	100 mm	140 mm	CTC-1597774	151.13
<b>MODEL 320B, 320BL</b>							
BOOM							
	1183953		P-UB-10	100 mm	140 mm	CTC-1373764	322.72
	1183955		P-UB-10	100 mm	140 mm	CTC-1373764	322.72
	1184023		P-UB-10	85 mm	120 mm	CTC-1373763	369.78
	1184128		P-UB-10	85 mm	120 mm	CTC-1184131	249.86
	1195425		P-UB-10	75 mm	110 mm	CTC-1195435	295.44
	1232081		P-UB-10	105 mm	150 mm	CTC-1373767	418.82
	1336770		P-UB-10	100 mm	140 mm	CTC-1336823	321.13
	1589058		P-UB-10	85 mm	120 mm	CTC-1589092	182.36
	1842614		P-UB-10	95 mm	160 mm	CTC-1884457	219.32
BUCKET							
	1183967		P-UB-10	85 mm	120 mm	CTC-1261947	346.12
	1184134		P-UB-10	85 mm	120 mm	CTC-1184131	249.86
	1195447		P-UB-10	65 mm	100 mm	CTC-1195457	214.51
	1232044		P-UB-10	90 mm	130 mm	CTC-1764914	141.89
	1232084		P-UB-10	90 mm	130 mm	CTC-1373768	440.48
	1251547		P-UB-10	65 mm	100 mm	CTC-418914	204.39
	1346987		P-UB-10	65 mm	100 mm	CTC-1764935	221.28
	1475780		P-UB-10	85 mm	125 mm	CTC-1475781	287.61
	1540756		P-UB-10	90 mm	130 mm	CTC-1540757	448.38
	1589061		P-UB-10	85 mm	120 mm	CTC-1589092	182.36
	1799764		P-UB-10	90 mm	130 mm	CTC-1799772	206.74
	417652		P-UB-10	65 mm	100 mm	CTC-417664	204.47
	418840		P-UB-10	65 mm	100 mm	CTC-418914	204.39
STICK							
	1184000		P-UB-10	105 mm	150 mm	CTC-1680758	349.00
	1232081		P-UB-10	105 mm	150 mm	CTC-1373767	418.82
	1412609		P-UB-10	95 mm	160 mm	CTC-1855574	189.05
	1589059		P-UB-10	100 mm	140 mm	CTC-1589093	122.51
	1589060		P-UB-10	100 mm	140 mm	CTC-1589093	122.51
TILT CAB							
	N/A		P-UB-10	2-1/4	5	CTC-9X6392	160.01



## REPLACEMENT KITS FOR CATERPILLAR® EQUIPMENT

Excavators							
APPLICATION	CYL #	Misc-Parts, Instructions, etc.	CODE	ROD	BORE	KIT #	List \$
<b>MODEL 320B, 320BL</b>							
UNSPECIFIED APPLICATION							
	1336771		P-UB-10	105 mm	150 mm	CTC-1373767	418.82
	1336812		P-UB-10	90 mm	130 mm	CTC-1373768	440.48
	1336866		P-UB-10	100 mm	140 mm	CTC-1373661	149.14
	1336867		P-UB-10	100 mm	140 mm	CTC-1373661	149.14
	1540727		P-UB-10	85 mm	120 mm	CTC-1540728	487.73
	1540743		P-UB-10	85 mm	120 mm	CTC-1540744	469.05
	1540772		P-UB-10	90 mm	130 mm	CTC-1540773	448.08
<b>MODEL 320C</b>							
BOOM							
AMC1-UP; ANB1-UP; BBC1-UP; BDC1-UP; BEF1-UP; BER1-UP; BPR1-UP; BRXI-UP							
	1588991		P-UB-10	85 mm	120 mm	CTC-1373763	369.78
	1588991		Bushing	85 mm		CTC-0964402	33.54
AMC1-UP; ANB1-UP; BDC1-UP; BER1-UP; BPR1-UP; BRXI-UP; GNG1-UP; HKT1-UP; MAB1-UP; PAB1-UP; RAW1-UP; SBN1-UP							
	2043614		P-UB-10	85 mm	120 mm	CTC-2478998	162.84
	2043614		Bushing	85 mm		CTC-0964402	33.54
AMC1-UP; ANB1-UP; GHA1-UP; GNG1-UP; HBC1-UP; HKT1-UP; MAB1-UP; PAB1-UP							
	1850340		P-UB-10	85 mm	120 mm	CTC-2478996	162.84
	1850340		Bushing	85 mm		CTC-0964402	33.54
AMC1-UP; ANB1-UP; MAB1-UP; PAB1-UP							
	2043616		P-UB-10	100 mm	140 mm	CTC-2590633	154.13
	2043616		Bushing	100 mm		CTC-0965625	49.93
	2590702		P-UB-10	100 mm	140 mm	CTC-2590699	154.13
	2590702		Bushing	100 mm		CTC-0965625	49.93
AXK1-UP							
	1842614		P-UB-10	95 mm	160 mm	CTC-2521191	195.29
	1842614		Bushing	95 mm		CTC-6C6093	46.13
AXK1-UP; BBE1-UP; BBL1-UP; BCN1-UP; BDC1-UP; BEA1-UP; BER1-UP; DBG1-UP; GLA1-UP; JTG1-UP							
	1589058		P-UB-10	85 mm	120 mm	CTC-2366368	109.57
	1589058		Bushing	85 mm		CTC-1140756	35.81
BBC1-UP; BCB1-UP; BEF1-UP							
	2043614		P-UB-10	85 mm	120 mm	CTC-2043625	238.21
	2043614		Bushing	85 mm		CTC-0964402	33.54
BBE1-UP; BBL1-UP; BCN1-UP; BEA1-UP; DBG1-UP; GLA1-UP; JTG1-UP							
	1842614		P-UB-10	95 mm	160 mm	CTC-2521191	195.29
	1842614		Bushing	95 mm		CTC-6C6093	46.13
BDC1-UP; BER1-UP							
	1232081		P-UB-10	105 mm	150 mm	CTC-1373767	418.82
	1232081		Bushing	105 mm		CTC-0995572	42.95
BDC1-UP; BER1-UP; RAW1-UP; SBN1-UP							
	2043616		P-UB-10	100 mm	140 mm	CTC-2043626	306.21
	2043616		Bushing	100 mm		CTC-0965625	49.93
MAB1-UP; PAB1-UP							
	2742510		P-UB-10	85 mm	120 mm	CTC-2742511	117.70
	2742510		Bushing	85 mm		CTC-1140756	35.81
RAW1-UP; SBN1-UP							
	1589058		P-UB-10	85 mm	120 mm	CTC-1589092	182.36
	1589058		Bushing	85 mm		CTC-1140756	35.81
BUCKET							
ALF1-UP; BCB1-UP; BDC1-UP; BER1-UP							
	1346987		P-UB-10	65 mm	100 mm	CTC-1764935	221.28
	1346987		Bushing	65 mm		CTC-1140754	24.80

**CATERPILLAR®**



## REPLACEMENT KITS FOR CATERPILLAR® EQUIPMENT

Excavators							
APPLICATION	CYL #	Misc-Parts, Instructions, etc.	CODE	ROD	BORE	KIT #	List \$
<b>MODEL 320C</b>							
<b>BUCKET</b>							
<b>AMC1-UP; ANB1-UP</b>							
1588995			P-UB-10	100 mm	140 mm	CTC-1373764	322.72
1588995			Bushing	100 mm		CTC-0965625	49.93
2043618			P-UB-10	85 mm	125 mm	CTC-2479005	150.49
2043618			Bushing	85 mm		CTC-0964402	33.54
2836132			P-UB-10	85 mm	120 mm	CTC-2366368	109.57
2836132			Bushing	85 mm		CTC-1140756	35.81
<b>AMC1-UP; ANB1-UP; AXK1-UP; BBE1-UP; BBL1-UP; BCN1-UP; BEA1-UP; DBG1-UP; GLA1-UP; JTG1-UP</b>							
1589061			P-U-10	85 mm	120 mm	CTC-2366389	109.57
1589061			Bushing	85 mm		CTC-1140756	35.81
<b>AMC1-UP; ANB1-UP; BBC1-UP; BCB1-UP; BEF1-UP; BPR1-UP; BRXI-UP; RAW1-UP; SBN1-UP</b>							
2043617			P-UB-10	85 mm	120 mm	CTC-2043627	139.85
2043617			Bushing	85 mm		CTC-0964402	33.54
<b>AMC1-UP; ANB1-UP; BBC1-UP; BEF1-UP</b>							
1589088			P-UB-10	85 mm	125 mm	CTC-1850223	165.71
1589088			Bushing	85 mm		CTC-0964402	33.54
<b>AMC1-UP; ANB1-UP; BPR1-UP; BRXI-UP; GNG1-UP; HKT1-UP; MAB1-UP; PAB1-UP</b>							
2043689			P-UB-10	85 mm	120 mm	CTC-2479001	148.20
2043689			Bushing	85 mm		CTC-0964402	33.54
<b>AMC1-UP; ANB1-UP; GHA1-UP; GNG1-UP; HBC1-UP; HKT1-UP; MAB1-UP; PAB1-UP</b>							
1799793			P-UB-10	90 mm	130 mm	CTC-2590626	140.30
1799793			Bushing	90 mm		CTC-1052575	32.35
2043696			P-UB-10	85 mm	120 mm	CTC-2479000	148.20
2043696			Bushing	85 mm		CTC-0964402	33.54
<b>AMC1-UP; ANB1-UP; GHA1-UP; HBC1-UP</b>							
1850346			P-UB-10	85 mm	120 mm	CTC-1540744	469.05
1850346			Bushing	85 mm		CTC-0964402	33.54
<b>AMC1-UP; ANB1-UP; MAB1-UP; PAB1-UP</b>							
2096011			P-UB-10	90 mm	130 mm	CTC-2590627	140.30
2096011			Bushing	90 mm		CTC-1052575	32.35
2590694			P-UB-10	85 mm	120 mm	CTC-2590695	162.84
2590694			Bushing	85 mm		CTC-0964402	33.54
2590698			P-UB-10	100 mm	140 mm	CTC-2590699	154.13
2590698			Bushing	100 mm		CTC-0965625	49.93
2590705			P-UB-10	85 mm	120 mm	CTC-2590706	148.20
2590705			Bushing	85 mm		CTC-0964402	33.54
2590732			P-UB-10	90 mm	130 mm	CTC-2590719	141.98
2590732			Bushing	90 mm		CTC-1052575	32.35
<b>AMC1-UP; ANB1-UP; RAW1-UP; SBN1-UP</b>							
1588999			P-UB-10	90 mm	130 mm	CTC-1850196	165.14
1588999			Bushing	90 mm		CTC-1052575	32.35
<b>AXK1-UP</b>							
1799764			P-UB-10	90 mm	130 mm	CTC-2159986	125.06
1799764			Bushing	90 mm		CTC-1140758	41.30
<b>BBC1-UP; BCB1-UP; BEF1-UP</b>							
2043618			P-UB-10	85 mm	125 mm	CTC-2043628	150.49
2043618			Bushing	85 mm		CTC-0964402	33.54
<b>BBE1-UP; BBL1-UP; BCN1-UP; BEA1-UP; DBG1-UP; GLA1-UP; JTG1-UP</b>							
1799764			P-UB-10	90 mm	130 mm	CTC-2159986	125.06
1799764			Bushing	90 mm		CTC-1140758	41.30
2836132			P-UB-10	85 mm	120 mm	CTC-2366368	109.57
2836132			Bushing	85 mm		CTC-1140756	35.81

CATERPILLAR®



## REPLACEMENT KITS FOR CATERPILLAR® EQUIPMENT

Excavators							
APPLICATION	CYL #	Misc-Parts, Instructions, etc.	CODE	ROD	BORE	KIT #	List \$
<b>MODEL 320C</b>							
<b>BUCKET</b>							
<b>BCB1-UP</b>							
2043689			P-UB-10	85 mm	120 mm	CTC-2043692	148.20
2043689			Bushing	85 mm		CTC-0964402	33.54
2096011			P-UB-10	90 mm	130 mm	CTC-2043630	253.12
2096011			Bushing	90 mm		CTC-1052575	32.35
<b>BDC1-UP; BER1-UP; RAW1-UP; SBN1-UP</b>							
1589061			P-UB-10	85 mm	120 mm	CTC-1589092	182.36
1589061			Bushing	85 mm		CTC-1140756	35.81
1799764			P-UB-10	90 mm	130 mm	CTC-1799772	206.74
1799764			Bushing	90 mm		CTC-1140758	41.30
<b>BPR1-UP; BRXI-UP</b>							
1588997			P-UB-10	85 mm	120 mm	CTC-1261947	346.12
1588997			Bushing	85 mm		CTC-0964402	33.54
<b>MAB1-UP; PAB1-UP</b>							
2742521			P-UB-10	85 mm	120 mm	CTC-2742511	117.70
2742521			Bushing	85 mm		CTC-1140756	35.81
<b>STICK</b>							
<b>AMC1-UP; ANB1-UP; BBC1-UP; BCB1-UP; BEF1-UP; MAB1-UP; PAB1-UP</b>							
2043615			P-UB-10	100 mm	140 mm	CTC-2043626	306.21
2043615			Bushing	100 mm		CTC-0965625	49.93
<b>AMC1-UP; ANB1-UP; BBC1-UP; BEF1-UP; BPR1-UP; BRXI-UP; RAW1-UP; SBN1-UP</b>							
1588993			P-UB-10	100 mm	140 mm	CTC-1373764	322.72
1588993			Bushing	100 mm		CTC-0965625	49.93
<b>AMC1-UP; ANB1-UP; BPR1-UP; BRXI-UP; GNG1-UP; HKT1-UP; MAB1-UP; PAB1-UP</b>							
2144500			P-UB-10	100 mm	140 mm	CTC-2590635	154.13
2144500			Bushing	100 mm		CTC-0965625	49.93
<b>AMC1-UP; ANB1-UP; GHA1-UP; GNG1-UP; HBC1-UP; HKT1-UP; MAB1-UP; PAB1-UP</b>							
1850342			P-UB-10	100 mm	140 mm	CTC-2590631	154.13
1850342			Bushing	100 mm		CTC-0965625	49.93
1850344			P-UB-10	100 mm	140 mm	CTC-2590631	154.13
1850344			Bushing	100 mm		CTC-0965625	49.93
<b>AXK1-UP</b>							
1589059			P-UB-10	100 mm	140 mm	CTC-2159985	122.51
1589059			Bushing	100 mm		CTC-1140757	50.34
<b>AXK1-UP; BBE1-UP; BBL1-UP; BCN1-UP; BEA1-UP; DBG1-UP; GLA1-UP; JTG1-UP</b>							
1589060			P-UB-10	100 mm	140 mm	CTC-2159985	122.51
1589060			Bushing	100 mm		CTC-1140757	50.34
<b>BBC1-UP; BCB1-UP; BEF1-UP</b>							
2144500			P-UB-10	100 mm	140 mm	CTC-2144502	154.13
2144500			Bushing	100 mm		CTC-0965625	49.93
<b>BBE1-UP; BBL1-UP; BCN1-UP; BEA1-UP; DBG1-UP; GLA1-UP; JTG1-UP</b>							
1589059			P-UB-10	100 mm	140 mm	CTC-2095874	254.03
1589059			Bushing	100 mm		CTC-1140757	50.34
<b>BCB1-UP</b>							
1232081			P-UB-10	105 mm	150 mm	CTC-1373767	418.82
1232081			Bushing	105 mm		CTC-0995572	42.95
2043616			P-UB-10	100 mm	140 mm	CTC-2043616	154.13
2043616			Bushing	100 mm		CTC-0965625	49.93
<b>BDC1-UP; BER1-UP; RAW1-UP; SBN1-UP</b>							
1589059			P-UB-10	100 mm	140 mm	CTC-2159985	122.51
1589059			Bushing	100 mm		CTC-1140757	50.34
1589060			P-UB-10	100 mm	140 mm	CTC-2095874	254.03
1589060			Bushing	100 mm		CTC-1140757	50.34
<b>BPR1-UP; BRXI-UP; GNG1-UP; HKT1-UP</b>							
2043615			P-UB-10	100 mm	140 mm	CTC-2590633	154.13
2043615			Bushing	100 mm		CTC-0965625	49.93

CATERPILLAR®



## REPLACEMENT KITS FOR CATERPILLAR® EQUIPMENT

Excavators							
APPLICATION	CYL #	Misc-Parts, Instructions, etc.	CODE	ROD	BORE	KIT #	List \$
<b>MODEL 320C</b>							
<b>STICK</b>							
MAB1-UP; PAB1-UP							
2742514			P-UB-10	100 mm	140 mm	CTC-2742515	169.37
2742514			Bushing	100 mm		CTC-1140757	50.34
RAW1-UP; SBN1-UP							
2043615			P-UB-10	100 mm	140 mm	CTC-1373764	322.72
2043615			Bushing	100 mm		CTC-0965625	49.93
<b>UNSPECIFIED APPLICATION</b>							
AKH1-UP; ALF1-UP							
1980648			I-U-10	45 mm	60 mm	CTC-1980648K	46.82
<b>MODEL 320C L</b>							
<b>BOOM</b>							
AMC1-UP; ANB1-UP; BBC1-UP; BDC1-UP; BEF1-UP; BER1-UP; BPR1-UP; BRX1-UP							
1588991			P-UB-10	85 mm	120 mm	CTC-1373763	369.78
1588991			Bushing	85 mm		CTC-0964402	33.54
AMC1-UP; ANB1-UP; BDC1-UP; BER1-UP; BPR1-UP; BRX1-UP; EAG1-UP; GNG1-UP; HKT1-UP; MAB1-UP; PAB1-UP; RAW1-UP; SBN1-UP							
2043614			P-UB-10	85 mm	120 mm	CTC-2478998	162.84
2043614			Bushing	85 mm		CTC-0964402	33.54
AMC1-UP; ANB1-UP; GHA1-UP; GNG1-UP; HBC1-UP; HKT1-UP; MAB1-UP; PAB1-UP							
1850340			P-UB-10	85 mm	120 mm	CTC-2478996	162.84
1850340			Bushing	85 mm		CTC-0964402	33.54
AMC1-UP; ANB1-UP; MAB1-UP; PAB1-UP							
2043616			P-UB-10	100 mm	140 mm	CTC-2590633	154.13
2043616			Bushing	100 mm		CTC-0965625	49.93
2590702			P-UB-10	100 mm	140 mm	CTC-2590699	154.13
2590702			Bushing	100 mm		CTC-0965625	49.93
AXK1-UP							
1842614			P-UB-10	95 mm	160 mm	CTC-2521191	195.29
1842614			Bushing	95 mm		CTC-6C6093	46.13
AXK1-UP; BBE1-UP; BBL1-UP; BCN1-UP; BDC1-UP; BEA1-UP; BER1-UP; DBG1-UP; GLA1-UP; JTG1-UP							
1589058			P-UB-10	85 mm	120 mm	CTC-2366368	109.57
1589058			Bushing	85 mm		CTC-1140756	35.81
BBC1-UP; BCB1-UP; BEF1-UP							
2043614			P-UB-10	85 mm	120 mm	CTC-2043625	238.21
2043614			Bushing	85 mm		CTC-0964402	33.54
BBE1-UP; BBL1-UP; BCN1-UP; BEA1-UP; DBG1-UP; GLA1-UP; JTG1-UP							
1842614			P-UB-10	95 mm	160 mm	CTC-2521191	195.29
1842614			Bushing	95 mm		CTC-6C6093	46.13
BDC1-UP; BER1-UP							
1232081			P-UB-10	105 mm	150 mm	CTC-1373767	418.82
1232081			Bushing	105 mm		CTC-0995572	42.95
BDC1-UP; BER1-UP; RAW1-UP; SBN1-UP							
2043616			P-UB-10	100 mm	140 mm	CTC-2043626	306.21
2043616			Bushing	100 mm		CTC-0965625	49.93
MAB1-UP; PAB1-UP							
2742510			P-UB-10	85 mm	120 mm	CTC-2742511	117.70
2742510			Bushing	85 mm		CTC-1140756	35.81
RAW1-UP; SBN1-UP							
1589058			P-UB-10	85 mm	120 mm	CTC-1589092	182.36
1589058			Bushing	85 mm		CTC-1140756	35.81
<b>BUCKET</b>							
ALF1-UP; BCB1-UP; BDC1-UP; BER1-UP							
1346987			P-UB-10	65 mm	100 mm	CTC-1764935	221.28
1346987			Bushing	65 mm		CTC-1140754	24.80

**CATERPILLAR®**



## REPLACEMENT KITS FOR CATERPILLAR® EQUIPMENT

Excavators							
APPLICATION	CYL #	Misc-Parts, Instructions, etc.	CODE	ROD	BORE	KIT #	List \$
MODEL 320C L							
BUCKET							
AMC1-UP; ANB1-UP							
1588995			P-UB-10	100 mm	140 mm	CTC-1373764	322.72
1588995			Bushing	100 mm		CTC-0965625	49.93
2043618			P-UB-10	85 mm	125 mm	CTC-2479005	150.49
2043618			Bushing	85 mm		CTC-0964402	33.54
2590705			P-UB-10	85 mm	120 mm	CTC-2590706	148.20
2590705			Bushing	85 mm		CTC-0964402	33.54
2836132			P-UB-10	85 mm	120 mm	CTC-2366368	109.57
2836132			Bushing	85 mm		CTC-1140756	35.81
AMC1-UP; ANB1-UP; AXK1-UP; BBE1-UP; BBL1-UP; BCN1-UP; BEA1-UP; DBG1-UP; GLA1-UP; JTG1-UP							
1589061			P-U-10	85 mm	120 mm	CTC-2366389	109.57
1589061			Bushing	85 mm		CTC-1140756	35.81
AMC1-UP; ANB1-UP; BBC1-UP; BEF1-UP							
1589088			P-UB-10	85 mm	125 mm	CTC-1850223	165.71
1589088			Bushing	85 mm		CTC-0964402	33.54
AMC1-UP; ANB1-UP; BCB1-UP; BPR1-UP; BRX1-UP; RAW1-UP; SBN1-UP							
2043617			P-UB-10	85 mm	120 mm	CTC-2043627	139.85
2043617			Bushing	85 mm		CTC-0964402	33.54
AMC1-UP; ANB1-UP; BPR1-UP; BRX1-UP; EAG1-UP; GNG1-UP; HKT1-UP; MAB1-UP; PAB1-UP							
2043689			P-UB-10	85 mm	120 mm	CTC-2479001	148.20
2043689			Bushing	85 mm		CTC-0964402	33.54
AMC1-UP; ANB1-UP; GHA1-UP; GNG1-UP; HBC1-UP; HKT1-UP; MAB1-UP; PAB1-UP							
1799793			P-UB-10	90 mm	130 mm	CTC-2590626	140.30
1799793			Bushing	90 mm		CTC-1052575	32.35
2043696			P-UB-10	85 mm	120 mm	CTC-2479000	148.20
2043696			Bushing	85 mm		CTC-0964402	33.54
AMC1-UP; ANB1-UP; GHA1-UP; HBC1-UP							
1850346			P-UB-10	85 mm	120 mm	CTC-1540744	469.05
1850346			Bushing	85 mm		CTC-0964402	33.54
AMC1-UP; ANB1-UP; MAB1-UP; PAB1-UP							
2096011			P-UB-10	90 mm	130 mm	CTC-2590627	140.30
2096011			Bushing	90 mm		CTC-1052575	32.35
2590694			P-UB-10	85 mm	120 mm	CTC-2590695	162.84
2590694			Bushing	85 mm		CTC-0964402	33.54
2590698			P-UB-10	100 mm	140 mm	CTC-2590699	154.13
2590698			Bushing	100 mm		CTC-0965625	49.93
2590732			P-UB-10	90 mm	130 mm	CTC-2590719	141.98
2590732			Bushing	90 mm		CTC-1052575	32.35
AMC1-UP; ANB1-UP; RAW1-UP; SBN1-UP							
1588999			P-UB-10	90 mm	130 mm	CTC-1850196	165.14
1588999			Bushing	90 mm		CTC-1052575	32.35
AXK1-UP							
1799764			P-UB-10	90 mm	130 mm	CTC-2159986	125.06
1799764			Bushing	90 mm		CTC-1140758	41.30
BBC1-UP; BCB1-UP; BEF1-UP							
2043618			P-UB-10	85 mm	125 mm	CTC-2043628	150.49
2043618			Bushing	85 mm		CTC-0964402	33.54
BBC1-UP; BEF1-UP							
2043617			P-UB-10	85 mm	120 mm	CTC-2043627	139.85
2043617			Bushing	85 mm		CTC-0964402	33.54
BBE1-UP; BBL1-UP; BCN1-UP; BEA1-UP; DBG1-UP; GLA1-UP; JTG1-UP							
1799764			P-UB-10	90 mm	130 mm	CTC-2159986	125.06
1799764			Bushing	90 mm		CTC-1140758	41.30
2836132			P-UB-10	85 mm	120 mm	CTC-2366368	109.57
2836132			Bushing	85 mm		CTC-1140756	35.81

CATERPILLAR®



## REPLACEMENT KITS FOR CATERPILLAR® EQUIPMENT

Excavators							
APPLICATION	CYL #	Misc-Parts, Instructions, etc.	CODE	ROD	BORE	KIT #	List \$
MODEL 320C L							
BUCKET							
BCB1-UP							
2043689			P-UB-10	85 mm	120 mm	CTC-2043692	148.20
2043689			Bushing	85 mm		CTC-0964402	33.54
2096011			P-UB-10	90 mm	130 mm	CTC-2043630	253.12
2096011			Bushing	90 mm		CTC-1052575	32.35
BDC1-UP; BER1-UP; RAW1-UP; SBN1-UP							
1589061			P-UB-10	85 mm	120 mm	CTC-1589092	182.36
1589061			Bushing	85 mm		CTC-1140756	35.81
1799764			P-UB-10	90 mm	130 mm	CTC-1799772	206.74
1799764			Bushing	90 mm		CTC-1140758	41.30
BPR1-UP; BRXI-UP							
1588997			P-UB-10	85 mm	120 mm	CTC-1261947	346.12
1588997			Bushing	85 mm		CTC-0964402	33.54
MAB1-UP; PAB1-UP							
2590705			P-UB-10	85 mm	120 mm	CTC-2590706	148.20
2590705			Bushing	85 mm		CTC-0964402	33.54
2742521			P-UB-10	85 mm	120 mm	CTC-2742511	117.70
2742521			Bushing	85 mm		CTC-1140756	35.81
STICK							
AMC1-UP; ANB1-UP; BBC1-UP; BCB1-UP; BEF1-UP; MAB1-UP; PAB1-UP							
2043615			P-UB-10	100 mm	140 mm	CTC-2043626	306.21
2043615			Bushing	100 mm		CTC-0965625	49.93
AMC1-UP; ANB1-UP; BBC1-UP; BEF1-UP; BPR1-UP; BRXI-UP; RAW1-UP; SBN1-UP							
1588993			P-UB-10	100 mm	140 mm	CTC-1373764	322.72
1588993			Bushing	100 mm		CTC-0965625	49.93
AMC1-UP; ANB1-UP; BPR1-UP; BRXI-UP; GNG1-UP; HKT1-UP; MAB1-UP; PAB1-UP							
2144500			P-UB-10	100 mm	140 mm	CTC-2590635	154.13
2144500			Bushing	100 mm		CTC-0965625	49.93
AMC1-UP; ANB1-UP; GHA1-UP; GNG1-UP; HBC1-UP; HKT1-UP; MAB1-UP; PAB1-UP							
1850342			P-UB-10	100 mm	140 mm	CTC-2590631	154.13
1850342			Bushing	100 mm		CTC-0965625	49.93
1850344			P-UB-10	100 mm	140 mm	CTC-2590631	154.13
1850344			Bushing	100 mm		CTC-0965625	49.93
AXK1-UP							
1589059			P-UB-10	100 mm	140 mm	CTC-2159985	122.51
1589059			Bushing	100 mm		CTC-1140757	50.34
AXK1-UP; BBE1-UP; BBL1-UP; BCN1-UP; BEA1-UP; DBG1-UP; GLA1-UP; JTG1-UP							
1589060			P-UB-10	100 mm	140 mm	CTC-2159985	122.51
1589060			Bushing	100 mm		CTC-1140757	50.34
BBC1-UP; BCB1-UP; BEF1-UP							
2144500			P-UB-10	100 mm	140 mm	CTC-2144502	154.13
2144500			Bushing	100 mm		CTC-0965625	49.93
BBE1-UP; BBL1-UP; BCN1-UP; BEA1-UP; DBG1-UP; GLA1-UP; JTG1-UP							
1589059			P-UB-10	100 mm	140 mm	CTC-2095874	254.03
1589059			Bushing	100 mm		CTC-1140757	50.34
BCB1-UP							
1232081			P-UB-10	105 mm	150 mm	CTC-1373767	418.82
1232081			Bushing	105 mm		CTC-0995572	42.95
2043616			P-UB-10	100 mm	140 mm	CTC-2043616	154.13
2043616			Bushing	100 mm		CTC-0965625	49.93
BDC1-UP; BER1-UP; RAW1-UP; SBN1-UP							
1589059			P-UB-10	100 mm	140 mm	CTC-2159985	122.51
1589059			Bushing	100 mm		CTC-1140757	50.34
1589060			P-UB-10	100 mm	140 mm	CTC-2095874	254.03
1589060			Bushing	100 mm		CTC-1140757	50.34

CATERPILLAR®





## REPLACEMENT KITS FOR CATERPILLAR® EQUIPMENT

Excavators							
APPLICATION	CYL #	Misc-Parts, Instructions, etc.	CODE	ROD	BORE	KIT #	List \$
<b>MODEL 320C L</b>							
STICK							
BPR1-UP; BRXI-UP; EAG1-UP; GNG1-UP; HKT1-UP							
2043615			P-UB-10	100 mm	140 mm	CTC-2590633	154.13
2043615			Bushing	100 mm		CTC-0965625	49.93
EAG1-UP							
2144500			P-UB-10	100 mm	140 mm	CTC-2590635	154.13
MAB1-UP; PAB1-UP							
2742514			P-UB-10	100 mm	140 mm	CTC-2742515	169.37
2742514			Bushing	100 mm		CTC-1140757	50.34
RAW1-UP; SBN1-UP							
2043615			P-UB-10	100 mm	140 mm	CTC-1373764	322.72
2043615			Bushing	100 mm		CTC-0965625	49.93
UNSPECIFIED APPLICATION							
AKH1-UP; ALF1-UP							
1980648			I-U-10	45 mm	60 mm	CTC-1980648K	46.82
<b>MODEL 320C LN</b>							
BOOM							
BBE1-UP; BBL1-UP; BCN1-UP; BEA1-UP; DBG1-UP; GLA1-UP; JTG1-UP							
1589058			P-UB-10	85 mm	120 mm	CTC-2366368	109.57
1589058			Bushing	85 mm		CTC-1140756	35.81
1842614			P-UB-10	95 mm	160 mm	CTC-2521191	195.29
1842614			Bushing	95 mm		CTC-6C6093	46.13
BUCKET							
BBE1-UP; BBL1-UP; BCN1-UP; BEA1-UP; DBG1-UP; GLA1-UP; JTG1-UP							
1589061			P-U-10	85 mm	120 mm	CTC-2366389	109.57
1589061			Bushing	85 mm		CTC-1140756	35.81
1799764			P-UB-10	90 mm	130 mm	CTC-2159986	125.06
1799764			Bushing	90 mm		CTC-1140758	41.30
2836132			P-UB-10	85 mm	120 mm	CTC-2366368	109.57
2836132			Bushing	85 mm		CTC-1140756	35.81
STICK							
BBE1-UP; BBL1-UP; BCN1-UP; BEA1-UP; DBG1-UP; GLA1-UP; JTG1-UP							
1589059			P-UB-10	100 mm	140 mm	CTC-2095874	254.03
1589059			Bushing	100 mm		CTC-1140757	50.34
1589060			P-UB-10	100 mm	140 mm	CTC-2159985	122.51
1589060			Bushing	100 mm		CTC-1140757	50.34
<b>MODEL 320C LRR</b>							
BOOM							
GAD1-UP							
1589058			P-UB-10	85 mm	120 mm	CTC-2366368	109.57
1589058			Bushing	85 mm		CTC-1140756	35.81
STICK							
GAD1-UP							
1589059			P-UB-10	100 mm	140 mm	CTC-2159985	122.51
1589059			Bushing	100 mm		CTC-1140757	50.34
<b>MODEL 320C LU</b>							
BOOM							
CLM1-UP; CLZ1-UP							
1588991			P-UB-10	85 mm	120 mm	CTC-1373763	369.78
1588991			Bushing	85 mm		CTC-0964402	33.54
CLM1-UP; CLZ1-UP; MAC1-UP; PAC1-UP							
1850340			P-UB-10	85 mm	120 mm	CTC-2478996	162.84
1850340			Bushing	85 mm		CTC-0964402	33.54
2043614			P-UB-10	85 mm	120 mm	CTC-2478998	162.84
2043614			Bushing	85 mm		CTC-0964402	33.54

CATERPILLAR®



## REPLACEMENT KITS FOR CATERPILLAR® EQUIPMENT

Excavators							
APPLICATION	CYL #	Misc-Parts, Instructions, etc.	CODE	ROD	BORE	KIT #	List \$
<b>MODEL 320C LU</b>							
BOOM							
MAC1-UP; PAC1-UP							
	2742510		P-UB-10	85 mm	120 mm	CTC-2742511	117.70
	2742510		Bushing	85 mm		CTC-1140756	35.81
BUCKET							
CLM1-UP; CLZ1-UP							
	1850346		P-UB-10	85 mm	120 mm	CTC-1540744	469.05
	1850346		Bushing	85 mm		CTC-0964402	33.54
	2043617		P-UB-10	85 mm	120 mm	CTC-2043627	139.85
	2043617		Bushing	85 mm		CTC-0964402	33.54
	2043696		P-UB-10	85 mm	120 mm	CTC-2479000	148.20
	2043696		Bushing	85 mm		CTC-0964402	33.54
CLM1-UP; CLZ1-UP; MAC1-UP; PAC1-UP							
	2043689		P-UB-10	85 mm	120 mm	CTC-2479001	148.20
	2043689		Bushing	85 mm		CTC-0964402	33.54
MAC1-UP; PAC1-UP							
	2590694		P-UB-10	85 mm	120 mm	CTC-2590695	162.84
	2590694		Bushing	85 mm		CTC-0964402	33.54
	2590698		P-UB-10	100 mm	140 mm	CTC-2590699	154.13
	2590698		Bushing	100 mm		CTC-0965625	49.93
	2590705		P-UB-10	85 mm	120 mm	CTC-2590706	148.20
	2590705		Bushing	85 mm		CTC-0964402	33.54
	2742521		P-UB-10	85 mm	120 mm	CTC-2742511	117.70
	2742521		Bushing	85 mm		CTC-1140756	35.81
STICK							
CLM1-UP; CLZ1-UP							
	1588993		P-UB-10	100 mm	140 mm	CTC-1373764	322.72
	1588993		Bushing	100 mm		CTC-0965625	49.93
CLM1-UP; CLZ1-UP; MAC1-UP; PAC1-UP							
	1850342		P-UB-10	100 mm	140 mm	CTC-2590631	154.13
	1850342		Bushing	100 mm		CTC-0965625	49.93
	2043615		P-UB-10	100 mm	140 mm	CTC-2590633	154.13
	2043615		Bushing	100 mm		CTC-0965625	49.93
MAC1-UP; PAC1-UP							
	2742514		P-UB-10	100 mm	140 mm	CTC-2742515	169.37
	2742514		Bushing	100 mm		CTC-1140757	50.34
<b>MODEL 320C S</b>							
BOOM							
BBE1-UP; BBL1-UP; BCN1-UP; BEA1-UP; BMZ1-UP; EGL1-UP							
	1589058		P-UB-10	85 mm	120 mm	CTC-2366368	109.57
	1589058		Bushing	85 mm		CTC-1140756	35.81
BBE1-UP; BBL1-UP; BCN1-UP; BEA1-UP; EGL1-UP							
	1842614		P-UB-10	95 mm	160 mm	CTC-2521191	195.29
	1842614		Bushing	95 mm		CTC-6C6093	46.13
BMZ1-UP							
	1842614		P-UB-10	95 mm	160 mm	CTC-2521191	195.29
	1842614		Bushing	95 mm		CTC-6C6093	46.13
BUCKET							
BBE1-UP; BBL1-UP; BCN1-UP; BEA1-UP; BMZ1-UP; EGL1-UP							
	1589061		P-U-10	85 mm	120 mm	CTC-2366389	109.57
	1589061		Bushing	85 mm		CTC-1140756	35.81
BBE1-UP; BBL1-UP; BCN1-UP; BEA1-UP; EGL1-UP							
	1799764		P-UB-10	90 mm	130 mm	CTC-2159986	125.06
	1799764		Bushing	90 mm		CTC-1140758	41.30
	2836132		P-UB-10	85 mm	120 mm	CTC-2366368	109.57
	2836132		Bushing	85 mm		CTC-1140756	35.81

**CATERPILLAR®**



## REPLACEMENT KITS FOR CATERPILLAR® EQUIPMENT

Excavators							
APPLICATION	CYL #	Misc-Parts, Instructions, etc.	CODE	ROD	BORE	KIT #	List \$
<b>MODEL 320C S</b>							
<b>BUCKET</b>							
BMZ1-UP							
	1799764		P-UB-10	90 mm	130 mm	CTC-2159986	125.06
	1799764		Bushing	90 mm		CTC-1140758	41.30
<b>STICK</b>							
BBE1-UP; BBL1-UP; BCN1-UP; BEA1-UP; BMZ1-UP; EGL1-UP							
	1589060		P-UB-10	100 mm	140 mm	CTC-2159985	122.51
	1589060		Bushing	100 mm		CTC-1140757	50.34
BBE1-UP; BBL1-UP; BCN1-UP; BEA1-UP; EGL1-UP							
	1589059		P-UB-10	100 mm	140 mm	CTC-2095874	254.03
	1589059		Bushing	100 mm		CTC-1140757	50.34
BMZ1-UP							
	1589059		P-UB-10	100 mm	140 mm	CTC-2159985	122.51
	1589059		Bushing	100 mm		CTC-1140757	50.34
<b>MODEL 320C U</b>							
<b>BOOM</b>							
CLM1-UP; CLZ1-UP							
	1588991		P-UB-10	85 mm	120 mm	CTC-1373763	369.78
	1588991		Bushing	85 mm		CTC-0964402	33.54
CLM1-UP; CLZ1-UP; MAC1-UP; PAC1-UP							
	1850340		P-UB-10	85 mm	120 mm	CTC-2478996	162.84
	1850340		Bushing	85 mm		CTC-0964402	33.54
	2043614		P-UB-10	85 mm	120 mm	CTC-2478998	162.84
	2043614		Bushing	85 mm		CTC-0964402	33.54
MAC1-UP; PAC1-UP							
	2742510		P-UB-10	85 mm	120 mm	CTC-2742511	117.70
	2742510		Bushing	85 mm		CTC-1140756	35.81
<b>BUCKET</b>							
CLM1-UP; CLZ1-UP							
	1850346		P-UB-10	85 mm	120 mm	CTC-1540744	469.05
	1850346		Bushing	85 mm		CTC-0964402	33.54
	2043617		P-UB-10	85 mm	120 mm	CTC-2043627	139.85
	2043617		Bushing	85 mm		CTC-0964402	33.54
	2043696		P-UB-10	85 mm	120 mm	CTC-2479000	148.20
	2043696		Bushing	85 mm		CTC-0964402	33.54
CLM1-UP; CLZ1-UP; MAC1-UP; PAC1-UP							
	2043689		P-UB-10	85 mm	120 mm	CTC-2479001	148.20
	2043689		Bushing	85 mm		CTC-0964402	33.54
MAC1-UP; PAC1-UP							
	2590694		P-UB-10	85 mm	120 mm	CTC-2590695	162.84
	2590694		Bushing	85 mm		CTC-0964402	33.54
	2590698		P-UB-10	100 mm	140 mm	CTC-2590699	154.13
	2590698		Bushing	100 mm		CTC-0965625	49.93
	2590705		P-UB-10	85 mm	120 mm	CTC-2590706	148.20
	2590705		Bushing	85 mm		CTC-0964402	33.54
	2742521		P-UB-10	85 mm	120 mm	CTC-2742511	117.70
	2742521		Bushing	85 mm		CTC-1140756	35.81
<b>STICK</b>							
CLM1-UP; CLZ1-UP							
	1588993		P-UB-10	100 mm	140 mm	CTC-1373764	322.72
	1588993		Bushing	100 mm		CTC-0965625	49.93
CLM1-UP; CLZ1-UP; MAC1-UP; PAC1-UP							
	1850342		P-UB-10	100 mm	140 mm	CTC-2590631	154.13
	1850342		Bushing	100 mm		CTC-0965625	49.93
	2043615		P-UB-10	100 mm	140 mm	CTC-2590633	154.13
	2043615		Bushing	100 mm		CTC-0965625	49.93

**CATERPILLAR®**



## REPLACEMENT KITS FOR CATERPILLAR® EQUIPMENT

Excavators							
APPLICATION	CYL #	Misc-Parts, Instructions, etc.	CODE	ROD	BORE	KIT #	List \$
<b>MODEL 320C U</b>							
STICK							
MAC1-UP; PAC1-UP							
2742514			P-UB-10	100 mm	140 mm	CTC-2742515	169.37
2742514			Bushing	100 mm		CTC-1140757	50.34
<b>MODEL 320C, 320CL, 320C6</b>							
STICK							
BEA; BDC; BDE; BCN; BER							
			P-UB-10	100 mm	140 mm	CTC-1589093	122.51
<b>MODEL 320D</b>							
BOOM							
A6F1-UP; A8F1-UP; CXY1-UP; DHK1-UP; FAL1-UP; JFZ1-UP; JGZ1-UP; KGF1-UP; MCH1-UP; MDE1-UP; MGG1-UP; PHX1-UP							
2426731			P-UB-10	85 mm	120 mm	CTC-2478868	160.00
2426731			Bushing	85 mm		CTC-0964402	33.54
A6F1-UP; A8F1-UP; CXY1-UP; DHK1-UP; FAL1-UP; KGF1-UP; MCH1-UP; PHX1-UP							
2426751			P-UB-10	100 mm	140 mm	CTC-2478878	196.88
2426751			Bushing	100 mm		CTC-0965625	49.93
BZP1-UP; JGZ1-UP; MDE1-UP							
2426746			P-UB-10	85 mm	120 mm	CTC-2667891	160.00
2426746			Bushing	85 mm		CTC-0964402	33.54
CXY1-UP; DHK1-UP							
2426746			P-UB-10	85 mm	120 mm	CTC-2667891	160.00
2667972			P-UB-10	85 mm	120 mm	CTC-2668011	160.00
2667972			Bushing	85 mm		CTC-0964402	33.54
FAL1-UP; KGF1-UP							
2426746			P-UB-10	85 mm	120 mm	CTC-2667891	160.00
2426746			Bushing	85 mm		CTC-0964402	33.54
GKS1-UP							
2897752			P-UB-10	100 mm	140 mm	CTC-2344566	146.21
2897752			Bushing	100 mm		CTC-0965625	49.93
BUCKET							
A6F1-UP; A8F1-UP; CXY1-UP; DHK1-UP; FAL1-UP; JFZ1-UP; JGZ1-UP; KGF1-UP; MCH1-UP; MDE1-UP; MGG1-UP; PHX1-UP							
2426756			P-UB-10	85 mm	120 mm	CTC-2478888	137.02
2426756			Bushing	85 mm		CTC-0964402	33.54
A6F1-UP; A8F1-UP; CXY1-UP; DHK1-UP; FAL1-UP; KGF1-UP; MCH1-UP; PHX1-UP							
2254591			P-UB-10	95 mm	135 mm	CTC-2344587	134.16
2254591			Bushing	95 mm		CTC-0964430	36.43
BZP1-UP; CXY1-UP; DHK1-UP; FAL1-UP; JGZ1-UP; KGF1-UP; MDE1-UP							
2426759			P-UB-10	85 mm	120 mm	CTC-2667892	137.02
2426759			Bushing	85 mm		CTC-0964402	33.54
CXY1-UP; DHK1-UP							
2667978			P-UB-10	85 mm	120 mm	CTC-2668057	137.02
2667978			Bushing	85 mm		CTC-0964402	33.54
CXY1-UP; DHK1-UP; FAL1-UP; JGZ1-UP; KGF1-UP; MDE1-UP							
2254599			P-UB-10	95 mm	135 mm	CTC-2590656	132.85
2254599			Bushing	95 mm		CTC-0964430	36.43
CAB TILT							
GKS1-UP							
2632914			P-UB-10	2-1/4	5	CTC-2417578	63.66
HEEL							
GKS1-UP							
2897756			P-UB-10	90 mm	130 mm	CTC-2590678	130.20
2897756			Bushing	90 mm		CTC-1052575	32.35
STICK							
A6F1-UP; A8F1-UP; CXY1-UP; DHK1-UP; FAL1-UP; JFZ1-UP; JGZ1-UP; KGF1-UP; MCH1-UP; MDE1-UP; MGG1-UP; PHX1-UP							
2426744			P-UB-10	100 mm	140 mm	CTC-2478974	196.88
2426744			Bushing	100 mm		CTC-0965625	49.93

**CATERPILLAR®**



## REPLACEMENT KITS FOR CATERPILLAR® EQUIPMENT

Excavators							
APPLICATION	CYL #	Misc-Parts, Instructions, etc.	CODE	ROD	BORE	KIT #	List \$
<b>MODEL 320D</b>							
STICK							
A6F1-UP; A8F1-UP; CXY1-UP; DHK1-UP; FAL1-UP; KGF1-UP; MCH1-UP; PHX1-UP							
2426734			P-UB-10	100 mm	140 mm	CTC-2478878	196.88
2426734			Bushing	100 mm		CTC-0965625	49.93
BZP1-UP; CXY1-UP; DHK1-UP; FAL1-UP; JGZ1-UP; KGF1-UP; MDE1-UP							
2426748			P-UB-10	100 mm	140 mm	CTC-2590775	196.88
2426748			Bushing	100 mm		CTC-0965625	49.93
CXY1-UP; DHK1-UP							
2667974			P-UB-10	100 mm	140 mm	CTC-2668012	196.88
2667974			Bushing	100 mm		CTC-0965625	49.93
CXY1-UP; DHK1-UP; FAL1-UP; JGZ1-UP; KGF1-UP; MDE1-UP							
2426763			P-UB-10	100 mm	140 mm	CTC-2590775	196.88
2426763			Bushing	100 mm		CTC-0965625	49.93
GKS1-UP							
2897754			P-UB-10	105 mm	150 mm	CTC-2344576	335.81
2897754			Bushing	105 mm		CTC-0995572	42.95
<b>MODEL 320D L</b>							
BOOM							
A6F1-UP; A8F1-UP; A9F1-UP; CXY1-UP; DHK1-UP; FAL1-UP; KGF1-UP; MCH1-UP; PHX1-UP							
2426751			P-UB-10	100 mm	140 mm	CTC-2478878	196.88
2426751			Bushing	100 mm		CTC-0965625	49.93
A6F1-UP; A8F1-UP; CXY1-UP; DHK1-UP; FAL1-UP; JFZ1-UP; JGZ1-UP; KGF1-UP; MCH1-UP; MDE1-UP; MGG1-UP; PHX1-UP							
2426731			P-UB-10	85 mm	120 mm	CTC-2478868	160.00
2426731			Bushing	85 mm		CTC-0964402	33.54
A9F1-UP							
2426731			P-UB-10	85 mm	120 mm	CTC-2478868	160.00
2426731			Bushing	85 mm		CTC-0964402	33.54
CXY1-UP; DHK1-UP							
2426746			P-UB-10	85 mm	120 mm	CTC-2667891	160.00
2667972			P-UB-10	85 mm	120 mm	CTC-2668011	160.00
2667972			Bushing	85 mm		CTC-0964402	33.54
FAL1-UP; KGF1-UP							
2426746			P-UB-10	85 mm	120 mm	CTC-2667891	160.00
2426746			Bushing	85 mm		CTC-0964402	33.54
JGZ1-UP; MDE1-UP							
2426746			P-UB-10	85 mm	120 mm	CTC-2667891	160.00
2426746			Bushing	85 mm		CTC-0964402	33.54
BUCKET							
A6F1-UP; A8F1-UP; A9F1-UP; CXY1-UP; DHK1-UP; FAL1-UP; JFZ1-UP; JGZ1-UP; KGF1-UP; MCH1-UP; MDE1-UP; MGG1-UP; PHX1-UP							
2426756			P-UB-10	85 mm	120 mm	CTC-2478888	137.02
2426756			Bushing	85 mm		CTC-0964402	33.54
A6F1-UP; A8F1-UP; A9F1-UP; CXY1-UP; DHK1-UP; FAL1-UP; KGF1-UP; MCH1-UP; PHX1-UP							
2254591			P-UB-10	95 mm	135 mm	CTC-2344587	134.16
2254591			Bushing	95 mm		CTC-0964430	36.43
CXY1-UP; DHK1-UP							
2667978			P-UB-10	85 mm	120 mm	CTC-2668057	137.02
2667978			Bushing	85 mm		CTC-0964402	33.54
CXY1-UP; DHK1-UP; FAL1-UP; JGZ1-UP; KGF1-UP; MDE1-UP							
2254599			P-UB-10	95 mm	135 mm	CTC-2590656	132.85
2254599			Bushing	95 mm		CTC-0964430	36.43
2426759			P-UB-10	85 mm	120 mm	CTC-2667892	137.02
2426759			Bushing	85 mm		CTC-0964402	33.54

**CATERPILLAR®**



## REPLACEMENT KITS FOR CATERPILLAR® EQUIPMENT

Excavators							
APPLICATION	CYL #	Misc-Parts, Instructions, etc.	CODE	ROD	BORE	KIT #	List \$
<b>MODEL 320D L</b>							
<b>STICK</b>							
A6F1-UP; A8F1-UP; A9F1-UP; CXY1-UP; DHK1-UP; FAL1-UP; JFZ1-UP; JGZ1-UP; KGF1-UP; MCH1-UP; MDE1-UP; MGG1-UP; PHX1-UP							
2426744		P-UB-10		100 mm	140 mm	CTC-2478974	196.88
2426744		Bushing		100 mm		CTC-0965625	49.93
A6F1-UP; A8F1-UP; A9F1-UP; CXY1-UP; DHK1-UP; FAL1-UP; KGF1-UP; MCH1-UP; PHX1-UP							
2426734		P-UB-10		100 mm	140 mm	CTC-2478878	196.88
2426734		Bushing		100 mm		CTC-0965625	49.93
CXY1-UP; DHK1-UP							
2667974		P-UB-10		100 mm	140 mm	CTC-2668012	196.88
2667974		Bushing		100 mm		CTC-0965625	49.93
CXY1-UP; DHK1-UP; FAL1-UP; JGZ1-UP; KGF1-UP; MDE1-UP							
2426748		P-UB-10		100 mm	140 mm	CTC-2590775	196.88
2426748		Bushing		100 mm		CTC-0965625	49.93
2426763		P-UB-10		100 mm	140 mm	CTC-2590775	196.88
2426763		Bushing		100 mm		CTC-0965625	49.93
<b>MODEL 320D LN</b>							
<b>BOOM</b>							
WBN1-UP							
2426731		P-UB-10		85 mm	120 mm	CTC-2478868	160.00
2426731		Bushing		85 mm		CTC-0964402	33.54
2426746		P-UB-10		85 mm	120 mm	CTC-2667891	160.00
2426746		Bushing		85 mm		CTC-0964402	33.54
2667972		P-UB-10		85 mm	120 mm	CTC-2668011	160.00
2667972		Bushing		85 mm		CTC-0964402	33.54
<b>BUCKET</b>							
WBN1-UP							
2426756		P-UB-10		85 mm	120 mm	CTC-2478888	137.02
2426756		Bushing		85 mm		CTC-0964402	33.54
2426759		P-UB-10		85 mm	120 mm	CTC-2667892	137.02
2426759		Bushing		85 mm		CTC-0964402	33.54
2667978		P-UB-10		85 mm	120 mm	CTC-2668057	137.02
2667978		Bushing		85 mm		CTC-0964402	33.54
<b>STICK</b>							
WBN1-UP							
2426734		P-UB-10		100 mm	140 mm	CTC-2478878	196.88
2426734		Bushing		100 mm		CTC-0965625	49.93
2426748		P-UB-10		100 mm	140 mm	CTC-2590775	196.88
2426748		Bushing		100 mm		CTC-0965625	49.93
2667974		P-UB-10		100 mm	140 mm	CTC-2668012	196.88
2667974		Bushing		100 mm		CTC-0965625	49.93
<b>MODEL 320D LRR</b>							
<b>BOOM</b>							
EBY1-UP							
2667972		P-UB-10		85 mm	120 mm	CTC-2668011	160.00
2667972		Bushing		85 mm		CTC-0964402	33.54
EBY1-UP; FXK1-UP; GKL1-UP; TAE1-UP; WFD1-UP; XCK1-UP; ZGB1-UP							
2426731		P-UB-10		85 mm	120 mm	CTC-2478868	160.00
2426731		Bushing		85 mm		CTC-0964402	33.54
EBY1-UP; GKL1-UP; TAE1-UP							
2426746		P-UB-10		85 mm	120 mm	CTC-2667891	160.00
2426746		Bushing		85 mm		CTC-0964402	33.54
<b>BUCKET</b>							
EBY1-UP							
2667978		P-UB-10		85 mm	120 mm	CTC-2668057	137.02
2667978		Bushing		85 mm		CTC-0964402	33.54

**CATERPILLAR®**



## REPLACEMENT KITS FOR CATERPILLAR® EQUIPMENT

Excavators							
APPLICATION	CYL #	Misc-Parts, Instructions, etc.	CODE	ROD	BORE	KIT #	List \$
<b>MODEL 320D LRR</b>							
BUCKET							
EBY1-UP; FXK1-UP; GKL1-UP; TAE1-UP							
2426759			P-UB-10	85 mm	120 mm	CTC-2667892	137.02
2426759			Bushing	85 mm		CTC-0964402	33.54
EBY1-UP; FXK1-UP; GKL1-UP; TAE1-UP; WFD1-UP; XCK1-UP; ZGB1-UP							
2426756			P-UB-10	85 mm	120 mm	CTC-2478888	137.02
2426756			Bushing	85 mm		CTC-0964402	33.54
STICK							
EBY1-UP							
2667974			P-UB-10	100 mm	140 mm	CTC-2668012	196.88
2667974			Bushing	100 mm		CTC-0965625	49.93
EBY1-UP; FXK1-UP; GKL1-UP; TAE1-UP; WFD1-UP; XCK1-UP							
2426744			P-UB-10	100 mm	140 mm	CTC-2478974	196.88
2426744			Bushing	100 mm		CTC-0965625	49.93
EBY1-UP; FXK1-UP; GKL1-UP; TAE1-UP; WFD1-UP; XCK1-UP; ZGB1-UP							
2426734			P-UB-10	100 mm	140 mm	CTC-2478878	196.88
2426734			Bushing	100 mm		CTC-0965625	49.93
EBY1-UP; GKL1-UP; TAE1-UP							
2426748			P-UB-10	100 mm	140 mm	CTC-2590775	196.88
2426748			Bushing	100 mm		CTC-0965625	49.93
<b>MODEL 320D RR</b>							
BOOM							
EBY1-UP							
2667972			P-UB-10	85 mm	120 mm	CTC-2668011	160.00
2667972			Bushing	85 mm		CTC-0964402	33.54
EBY1-UP; FXK1-UP; GKL1-UP; WFD1-UP; XCK1-UP; YDS1-UP							
2426731			P-UB-10	85 mm	120 mm	CTC-2478868	160.00
2426731			Bushing	85 mm		CTC-0964402	33.54
EBY1-UP; GKL1-UP; YDS1-UP							
2426746			P-UB-10	85 mm	120 mm	CTC-2667891	160.00
2426746			Bushing	85 mm		CTC-0964402	33.54
BUCKET							
EBY1-UP							
2667978			P-UB-10	85 mm	120 mm	CTC-2668057	137.02
2667978			Bushing	85 mm		CTC-0964402	33.54
EBY1-UP; FXK1-UP; GKL1-UP; WFD1-UP; XCK1-UP; YDS1-UP							
2426756			P-UB-10	85 mm	120 mm	CTC-2478888	137.02
2426756			Bushing	85 mm		CTC-0964402	33.54
EBY1-UP; FXK1-UP; GKL1-UP; YDS1-UP							
2426759			P-UB-10	85 mm	120 mm	CTC-2667892	137.02
2426759			Bushing	85 mm		CTC-0964402	33.54
STICK							
EBY1-UP							
2667974			P-UB-10	100 mm	140 mm	CTC-2668012	196.88
2667974			Bushing	100 mm		CTC-0965625	49.93
EBY1-UP; FXK1-UP; GKL1-UP; WFD1-UP; XCK1-UP; YDS1-UP							
2426734			P-UB-10	100 mm	140 mm	CTC-2478878	196.88
2426734			Bushing	100 mm		CTC-0965625	49.93
2426744			P-UB-10	100 mm	140 mm	CTC-2478974	196.88
2426744			Bushing	100 mm		CTC-0965625	49.93
EBY1-UP; GKL1-UP; YDS1-UP							
2426748			P-UB-10	100 mm	140 mm	CTC-2590775	196.88
2426748			Bushing	100 mm		CTC-0965625	49.93
<b>MODEL 320L</b>							
BOOM							
874898			P-UB-10	85 mm	120 mm	CTC-1764934	232.55

**CATERPILLAR®**





## REPLACEMENT KITS FOR CATERPILLAR® EQUIPMENT

Excavators							
APPLICATION	CYL #	Misc-Parts, Instructions, etc.	CODE	ROD	BORE	KIT #	List \$
<b>MODEL 320L</b>							
BUCKET							
	1251547		P-UB-10	65 mm	100 mm	CTC-4I8914	204.39
	4I7652		P-UB-10	65 mm	100 mm	CTC-4I7664	204.47
	4I8840		P-UB-10	65 mm	100 mm	CTC-4I8914	204.39
	7I7291		P-UB-10	85 mm	130 mm	CTC-7Y5145	267.26
	7Y5100		P-UB-10	85 mm	130 mm	CTC-7Y5145	267.26
STICK							
	7Y4650		P-UB-10	105 mm	150 mm	CTC-1163612	301.76
	875493		P-UB-10	100 mm	140 mm	CTC-1270630	340.15
<b>MODEL 320N</b>							
BOOM							
	874898		P-UB-10	85 mm	120 mm	CTC-1764934	232.55
BUCKET							
	7Y5100		P-UB-10	85 mm	130 mm	CTC-7Y5145	267.26
STICK							
	875493		P-UB-10	100 mm	140 mm	CTC-1270630	340.15
<b>MODEL 320S</b>							
BOOM							
	0875496		P-UB-10	85 mm	120 mm	CTC-1184131	249.86
	1069596		P-UB-10	95 mm	160 mm	CTC-6C6091	336.81
BOOM VA							
	6C6085		P-UB-10	95 mm	160 mm	CTC-6C6091	336.81
BUCKET							
	0875633		P-UB-10	85 mm	120 mm	CTC-1184131	249.86
	7Y5100		P-UB-10	85 mm	130 mm	CTC-7Y5145	267.26
STICK							
	0875422		P-UB-10	100 mm	140 mm	CTC-0875387	341.66
	0876638		P-UB-10	100 mm	140 mm	CTC-0875387	341.66
<b>MODEL 321B</b>							
BUCKET							
	1232084		P-UB-10	90 mm	130 mm	CTC-1373768	440.48
UNSPECIFIED APPLICATION							
	1183967		P-UB-10	85 mm	120 mm	CTC-1261947	346.12
<b>MODEL 321C LCR</b>							
BLADE LH							
	KCR1-UP; MCF1-UP						
	1913288		P-UB-10	100 mm	140 mm	CTC-1645174	218.76
	1913288		Bushing	100 mm		CTC-0965625	49.93
BLADE RH							
	KCR1-UP; MCF1-UP						
	1913286		P-UB-10	100 mm	140 mm	CTC-1645174	218.76
	1913286		Bushing	100 mm		CTC-0965625	49.93
BOOM							
	KCR1-UP						
	2449116		P-UB-10	85 mm	120 mm	CTC-2478998	162.84
	2449116		Bushing	85 mm		CTC-0964402	33.54
	KCR1-UP; MCF1-UP						
	2160021		P-UB-10	90 mm	125 mm	CTC-2479004	135.00
	2160021		Bushing	90 mm		CTC-1052575	32.35
	MCF1-UP						
	2043614		P-UB-10	85 mm	120 mm	CTC-2043625	238.21
	2043614		Bushing	85 mm		CTC-0964402	33.54
BOOM LH							
	KCR1-UP; MCF1-UP						
	2160018		P-UB-10	90 mm	125 mm	CTC-2479004	135.00
	2160018		Bushing	90 mm		CTC-1052575	32.35

CATERPILLAR®



## REPLACEMENT KITS FOR CATERPILLAR® EQUIPMENT

Excavators							
APPLICATION	CYL #	Misc-Parts, Instructions, etc.	CODE	ROD	BORE	KIT #	List \$
<b>MODEL 321C LCR</b>							
<b>BUCKET</b>							
KCR1-UP							
2449120			P-UB-10	85 mm	120 mm	CTC-2479001	148.20
2449120			Bushing	85 mm		CTC-0964402	33.54
KCR1-UP; MCF1-UP							
2043689			P-UB-10	85 mm	120 mm	CTC-2479001	148.20
2043689			Bushing	85 mm		CTC-0964402	33.54
<b>STICK</b>							
KCR1-UP							
2424840			P-UB-10	100 mm	140 mm	CTC-2590633	154.13
2424840			Bushing	100 mm		CTC-0965625	49.93
KCR1-UP; MCF1-UP							
2043615			P-UB-10	100 mm	140 mm	CTC-2590633	154.13
2043615			Bushing	100 mm		CTC-0965625	49.93
<b>STICK LH</b>							
MCF1-UP							
2817970			P-UB-10	100 mm	140 mm	CTC-1373764	322.72
2817970			Bushing	100 mm		CTC-0965625	49.93
<b>STICK RH</b>							
MCF1-UP							
2817971			P-UB-10	100 mm	140 mm	CTC-1373764	322.72
2817971			Bushing	100 mm		CTC-0965625	49.93
<b>MODEL 321D LCR</b>							
<b>BLADE LH</b>							
PBD1-UP							
1913288			P-UB-10	100 mm	140 mm	CTC-1645174	218.76
1913288			Bushing	100 mm		CTC-0965625	49.93
<b>BLADE RH</b>							
PBD1-UP							
1913286			P-UB-10	100 mm	140 mm	CTC-1645174	218.76
1913286			Bushing	100 mm		CTC-0965625	49.93
<b>BOOM</b>							
PBD1-UP; TXA1-UP							
2426731			P-UB-10	85 mm	120 mm	CTC-2478868	160.00
2426731			Bushing	85 mm		CTC-0964402	33.54
2795614			P-UB-10	95 mm	160 mm	CTC-2521191	195.29
2795614			Bushing	95 mm		CTC-6C6093	46.13
<b>BOOM LH</b>							
KBZ1-UP; MDT1-UP; MPG1-UP; NAS1-UP; PBD1-UP; TXA1-UP							
2742689			P-UB-10	90 mm	125 mm	CTC-2835988	842.40
2742689			Bushing	90 mm		CTC-1052575	32.35
<b>BOOM RH</b>							
KBZ1-UP; MDT1-UP; MPG1-UP; NAS1-UP; PBD1-UP; TXA1-UP							
2742690			P-UB-10	90 mm	125 mm	CTC-2835988	842.40
2742690			Bushing	90 mm		CTC-1052575	32.35
<b>BUCKET</b>							
KBZ1-UP; MDT1-UP; MPG1-UP; NAS1-UP; PBD1-UP; TXA1-UP							
2426756			P-UB-10	85 mm	120 mm	CTC-2478888	137.02
2426756			Bushing	85 mm		CTC-0964402	33.54
KBZ1-UP; MPG1-UP; TXA1-UP							
3494134			P-UB-10	85 mm	120 mm	CTC-3500967	227.56
3494134			Bushing	85 mm		CTC-0964402	33.54
<b>STICK</b>							
KBZ1-UP; MDT1-UP; MPG1-UP; NAS1-UP; PBD1-UP; TXA1-UP							
2426734			P-UB-10	100 mm	140 mm	CTC-2478878	196.88
2426734			Bushing	100 mm		CTC-0965625	49.93

**CATERPILLAR®**



## REPLACEMENT KITS FOR CATERPILLAR® EQUIPMENT

Excavators							
APPLICATION	CYL #	Misc-Parts, Instructions, etc.	CODE	ROD	BORE	KIT #	List \$
<b>MODEL 322</b>							
BOOM							
	1052571		P-UB-10	90 mm	130 mm	CTC-1052585	484.06
	1052588		P-UB-10	100 mm	140 mm	CTC-1270630	340.15
	711345		P-UB-10	90 mm	130 mm	CTC-711360	296.64
BUCKET							
	0875633		P-UB-10	85 mm	120 mm	CTC-0875394	258.77
	0875633		P-UB-10	85 mm	120 mm	CTC-1184131	249.86
	1052597		P-UB-10	85 mm	130 mm	CTC-1052601	433.38
	1185931		P-UB-10	85 mm	120 mm	CTC-1186023	266.33
	418840		P-UB-10	65 mm	100 mm	CTC-418914	204.39
	717291		P-UB-10	85 mm	130 mm	CTC-7Y5145	267.26
	7Y5100		P-UB-10	85 mm	130 mm	CTC-7Y5145	267.26
	7Y5150		P-UB-10	105 mm	150 mm	CTC-1163612	301.76
STICK							
	717341		P-UB-10	100 mm	140 mm	CTC-0875387	341.66
<b>MODEL 322B, 322BL</b>							
BOOM							
	1140636		P-UB-10	100 mm	140 mm	CTC-1184024	325.48
	1184069		P-UB-10	90 mm	130 mm	CTC-1373765	475.98
	1184070		P-UB-10	100 mm	140 mm	CTC-1373764	322.72
	1184166		P-UB-10	90 mm	130 mm	CTC-1184175	295.27
	1336869		P-UB-10	90 mm	130 mm	CTC-1540748	288.09
BUCKET							
	1183921		P-UB-10	105 mm	150 mm	CTC-1163612	301.76
	1183921		P-UB-10	105 mm	150 mm	CTC-1680758	349.00
	1184008		P-UB-10	90 mm	130 mm	CTC-1184175	295.27
	1184134		P-UB-10	85 mm	120 mm	CTC-1184131	249.86
	1232044		P-UB-10	90 mm	130 mm	CTC-1184175	295.27
	1232084		P-UB-10	90 mm	130 mm	CTC-1373768	440.48
	1232091		P-UB-10	90 mm	130 mm	CTC-1261887	427.68
	1251547		P-UB-10	65 mm	100 mm	CTC-418914	204.39
	1336810		P-UB-10	105 mm	150 mm	CTC-1289277	367.94
	1346987		P-UB-10	65 mm	100 mm	CTC-1764935	221.28
	1540756		P-UB-10	90 mm	130 mm	CTC-1540757	448.38
	411726		P-UB-10	110 mm	160 mm	CTC-0876654	320.96
	418840		P-UB-10	65 mm	100 mm	CTC-418914	204.39
STICK							
	1163638		P-UB-10	110 mm	170 mm	CTC-1680759	400.71
	1183953		P-UB-10	100 mm	140 mm	CTC-1373764	322.72
	1184000		P-UB-10	105 mm	150 mm	CTC-1163612	301.76
	1184000		P-UB-10	105 mm	150 mm	CTC-1680758	349.00
	1184176		P-UB-10	100 mm	140 mm	CTC-1184024	325.48
	1336771		P-UB-10	105 mm	150 mm	CTC-1373767	418.82
	7Y4650		P-UB-10	105 mm	150 mm	CTC-7Y4698	336.22
TILT CAB							
	N/A		P-UB-10	2-1/4	5	CTC-9X6392	160.01
UNSPECIFIED APPLICATION							
	1183967		P-UB-10	85 mm	120 mm	CTC-1261947	346.12
	1540743		P-UB-10	85 mm	120 mm	CTC-1540744	469.05
	1540747		P-UB-10	90 mm	130 mm	CTC-1540748	288.09
<b>MODEL 322C</b>							
BOOM							
	BFK1-UP; BGR1-UP						
	1772440		P-UB-10	90 mm	130 mm	CTC-2159986	125.06
	1772440		Bushing	90 mm		CTC-1140758	41.30
	6C9407		P-UB-10	100 mm	170 mm	CTC-2330763	224.74
	6C9407		Bushing	100 mm		CTC-1140757	50.34

**CATERPILLAR®**



## REPLACEMENT KITS FOR CATERPILLAR® EQUIPMENT

Excavators							
APPLICATION	CYL #	Misc-Parts, Instructions, etc.	CODE	ROD	BORE	KIT #	List \$
<b>MODEL 322C</b>							
<b>BOOM</b>							
<b>BKM1-UP; BLP1-UP</b>							
1772440			P-UB-10	90 mm	130 mm	CTC-2159986	125.06
1772440			Bushing	90 mm		CTC-1140758	41.30
1915580			P-UB-10	90 mm	130 mm	CTC-2590625	159.82
1915580			Bushing	90 mm		CTC-1052575	32.35
2043619			P-UB-10	90 mm	130 mm	CTC-2590628	159.82
2043619			Bushing	90 mm		CTC-1052575	32.35
2590711			P-UB-10	90 mm	130 mm	CTC-2590712	161.49
2590711			Bushing	90 mm		CTC-1052575	32.35
2897878			P-UB-10	90 mm	130 mm	CTC-2897878K	160.35
2897878			Bushing	90 mm		CTC-1140758	41.30
<b>BPH1-UP; CAM1-UP; LAR1-UP; MZH1-UP</b>							
1772440			P-UB-10	90 mm	130 mm	CTC-1799772	206.74
1772440			Bushing	90 mm		CTC-1140758	41.30
2044910			P-UB-10	90 mm	130 mm	CTC-2044910K	137.51
2044910			Bushing	90 mm		CTC-1140758	41.30
2044912			P-UB-10	100 mm	140 mm	CTC-2044912K	176.23
2044912			Bushing	100 mm		CTC-1140757	50.34
<b>C3R1-UP; CBY1-UP</b>							
1756855			P-UB-10	100 mm	140 mm	CTC-1756855K	177.66
1756855			Bushing	100 mm		CTC-1140757	50.34
<b>DAA1-UP; FED1-UP</b>							
2742525			P-UB-10	90 mm	130 mm	CTC-2742526	124.86
2742525			Bushing	90 mm		CTC-1140758	41.30
<b>BUCKET</b>							
<b>BFK1-UP; BGR1-UP; BKM1-UP; BLP1-UP</b>							
1772446			P-UB-10	90 mm	130 mm	CTC-2159986	125.06
1772446			Bushing	90 mm		CTC-1140758	41.30
1772465			P-UB-10	105 mm	150 mm	CTC-1915619	162.21
1772465			Bushing	105 mm		CTC-1140760	54.85
2478853			P-UB-10	105 mm	150 mm	CTC-1915619	162.21
2478853			Bushing	105 mm		CTC-1140760	54.85
<b>BKM1-UP</b>							
1346987			P-UB-10	65 mm	100 mm	CTC-1764935	221.28
1346987			Bushing	65 mm		CTC-1140754	24.80
2043689			P-UB-10	85 mm	120 mm	CTC-2479001	148.20
2043689			Bushing	85 mm		CTC-0964402	33.54
<b>BKM1-UP; BLP1-UP</b>							
1772453			P-UB-10	90 mm	130 mm	CTC-1261887	427.68
1772453			Bushing	90 mm		CTC-1052575	32.35
1850346			P-UB-10	85 mm	120 mm	CTC-1540744	469.05
1850346			Bushing	85 mm		CTC-0964402	33.54
1915584			P-UB-10	90 mm	130 mm	CTC-2590626	140.30
1915584			Bushing	90 mm		CTC-1052575	32.35
2043621			P-UB-10	90 mm	130 mm	CTC-2590627	140.30
2043621			Bushing	90 mm		CTC-1052575	32.35
2043696			P-UB-10	85 mm	120 mm	CTC-2479000	148.20
2043696			Bushing	85 mm		CTC-0964402	33.54
2590705			P-UB-10	85 mm	120 mm	CTC-2590706	148.20
2590705			Bushing	85 mm		CTC-0964402	33.54
2590718			P-UB-10	90 mm	130 mm	CTC-2590719	141.98
2590718			Bushing	90 mm		CTC-1052575	32.35
2590746			P-UB-10	105 mm	150 mm	CTC-2590743	125.22
2590746			Bushing	105 mm		CTC-1140760	54.85
2897887			P-UB-10	90 mm	130 mm	CTC-2159986	125.06
2897887			Bushing	90 mm		CTC-1140758	41.30

**CATERPILLAR®**



## REPLACEMENT KITS FOR CATERPILLAR® EQUIPMENT

Excavators							
APPLICATION	CYL #	Misc-Parts, Instructions, etc.	CODE	ROD	BORE	KIT #	List \$
<b>MODEL 322C</b>							
<b>BUCKET</b>							
BKM243-UP; BLP180-UP							
2043617			P-UB-10	85 mm	120 mm	CTC-2043627	139.85
2043617			Bushing	85 mm		CTC-0964402	33.54
BPH1-UP; CAM1-UP; LAR1-UP; MZH1-UP							
2044914			P-UB-10	90 mm	130 mm	CTC-2044914K	113.53
2044914			Bushing	90 mm		CTC-1140758	41.30
C3R1-296; CBY1-UP							
1232044			P-UB-10	90 mm	130 mm	CTC-1764914	141.89
1232044			Bushing	90 mm		CTC-1140758	41.30
C3R297-UP							
1799764			P-UB-10	90 mm	130 mm	CTC-1799764K	125.06
1799764			Bushing	90 mm		CTC-1140758	41.30
DAA1-UP; FED1-UP							
2742521			P-UB-10	85 mm	120 mm	CTC-2742511	117.70
2742521			Bushing	85 mm		CTC-1140756	35.81
2742532			P-UB-10	90 mm	130 mm	CTC-2742526	124.86
2742532			Bushing	90 mm		CTC-1140758	41.30
<b>CAB TILT</b>							
BPH1-UP; C3R1001-UP; CAM1-UP; LAR1001-UP; LAR1-UP; MZH1-UP							
1175148			P-UB-10	2-1/4	5	CTC-2417578	63.66
2632914			P-UB-10	2-1/4	5	CTC-2417578	63.66
<b>GRAPPLE</b>							
CBY1-UP							
1504569			P-UB-10	2-1/2	4	CTC-1533724	213.96
<b>STICK</b>							
BFK1-UP; BGR1-UP; BKM1-UP; BLP1-UP							
1772443			P-UB-10	100 mm	140 mm	CTC-2159985	122.51
1772443			Bushing	100 mm		CTC-1140757	50.34
BKM1-UP							
1169123			P-UB-10	105 mm	150 mm	CTC-1997416	206.20
1169123			Bushing	105 mm		CTC-1140760	54.85
BKM1-UP; BLP1-UP							
1915582			P-UB-10	100 mm	140 mm	CTC-2590631	154.13
1915582			Bushing	100 mm		CTC-0965625	49.93
2043620			P-UB-10	100 mm	140 mm	CTC-2590633	154.13
2043620			Bushing	100 mm		CTC-0965625	49.93
2590715			P-UB-10	100 mm	140 mm	CTC-2590699	154.13
2590715			Bushing	100 mm		CTC-0965625	49.93
BPH1-UP; CAM1-UP; LAR1-UP; MZH1-UP							
1772443			P-UB-10	100 mm	140 mm	CTC-1589093	122.51
C3R1-UP; CBY1-UP							
1336771			P-UB-10	105 mm	150 mm	CTC-1373767	418.82
1336771			Bushing	105 mm		CTC-0995572	42.95
1433201			P-UB-10	110 mm	170 mm	CTC-1433201K	240.39
1433201			Bushing	110 mm		CTC-1140761	87.22
CBY1-UP							
1163638			P-UB-10	110 mm	170 mm	CTC-1680759	400.71
1163638			Bushing	110 mm		CTC-1140761	87.22
DAA1-UP; FED1-UP							
2742529			P-UB-10	100 mm	140 mm	CTC-2742515	169.37
2742529			Bushing	100 mm		CTC-1140757	50.34
2897884			P-UB-10	100 mm	140 mm	CTC-2478792	185.30
2897884			Bushing	100 mm		CTC-1140757	50.34

CATERPILLAR®



## REPLACEMENT KITS FOR CATERPILLAR® EQUIPMENT

Excavators							
APPLICATION	CYL #	Misc-Parts, Instructions, etc.	CODE	ROD	BORE	KIT #	List \$
<b>MODEL 322C FM LGP</b>							
<b>BOOM</b>							
BYL1-UP							
	1756855		P-UB-10	100 mm	140 mm	CTC-1756855K	177.66
	1756855		Bushing	100 mm		CTC-1140757	50.34
	1772440		P-UB-10	90 mm	130 mm	CTC-1799772	206.74
	1772440		Bushing	90 mm		CTC-1140758	41.30
<b>BUCKET</b>							
BYL1-UP							
	1799764		P-UB-10	90 mm	130 mm	CTC-1799764K	125.06
	1799764		Bushing	90 mm		CTC-1140758	41.30
<b>CAB TILT</b>							
BYL1001-UP							
	2632914	O-ring kit. 2 per application.	O-ring Kit			CTC-1143616	6.14
	2632914		P-UB-10	2-1/4	5	CTC-2417578	63.66
BYL1-UP							
	1175148	O-ring kit. 2 per application.	O-ring Kit			CTC-1143616	6.14
	1175148		P-UB-10	2-1/4	5	CTC-2417578	63.66
<b>STICK</b>							
BYL1-UP							
	1336771		P-UB-10	105 mm	150 mm	CTC-1373767	418.82
	1336771		Bushing	105 mm		CTC-0995572	42.95
	1913118		P-UB-10	110 mm	170 mm	CTC-1913171	240.39
	1913118		Bushing	110 mm		CTC-1140761	87.22
<b>MODEL 322C L</b>							
<b>BOOM</b>							
BKJ1-UP							
	1772440		P-UB-10	90 mm	130 mm	CTC-1799772	206.74
	1772440		Bushing	90 mm		CTC-1140758	41.30
	2044910		P-UB-10	90 mm	130 mm	CTC-2044910K	137.51
	2044910		Bushing	90 mm		CTC-1140758	41.30
	2044912		P-UB-10	100 mm	140 mm	CTC-2044912K	176.23
	2044912		Bushing	100 mm		CTC-1140757	50.34
BKM1-UP; BLP1-UP							
	1772440		P-UB-10	90 mm	130 mm	CTC-2159986	125.06
	1772440		Bushing	90 mm		CTC-1140758	41.30
	1915580		P-UB-10	90 mm	130 mm	CTC-2590625	159.82
	1915580		Bushing	90 mm		CTC-1052575	32.35
	2043619		P-UB-10	90 mm	130 mm	CTC-2590628	159.82
	2043619		Bushing	90 mm		CTC-1052575	32.35
	2590711		P-UB-10	90 mm	130 mm	CTC-2590712	161.49
	2590711		Bushing	90 mm		CTC-1052575	32.35
	2897878		P-UB-10	90 mm	130 mm	CTC-2897878K	160.35
	2897878		Bushing	90 mm		CTC-1140758	41.30
DAA1-UP; FED1-UP							
	2742525		P-UB-10	90 mm	130 mm	CTC-2742526	124.86
	2742525		Bushing	90 mm		CTC-1140758	41.30
EMR1-UP; MAR1-UP							
	1772440		P-UB-10	90 mm	130 mm	CTC-2159986	125.06
	1772440		Bushing	90 mm		CTC-1140758	41.30
	2113069		P-UB-10	100 mm	170 mm	CTC-2519341	264.56
	2113069		Bushing	100 mm		CTC-1140757	50.34
<b>BUCKET</b>							
BKJ1-UP							
	1589061		P-U-10	85 mm	120 mm	CTC-2366389	109.57
	1589061		Bushing	85 mm		CTC-1140756	35.81
	2044914		P-UB-10	90 mm	130 mm	CTC-2044914K	113.53
	2044914		Bushing	90 mm		CTC-1140758	41.30

CATERPILLAR®



## REPLACEMENT KITS FOR CATERPILLAR® EQUIPMENT

Excavators							
APPLICATION	CYL #	Misc-Parts, Instructions, etc.	CODE	ROD	BORE	KIT #	List \$
<b>MODEL 322C L</b>							
<b>BUCKET</b>							
<b>BKJ1-UP; BKM1-UP</b>							
1346987			P-UB-10	65 mm	100 mm	CTC-1764935	221.28
1346987			Bushing	65 mm		CTC-1140754	24.80
<b>BKJ1-UP; BKM1-UP; BLP1-UP; EMR1-UP; MAR1-UP</b>							
1772446			P-UB-10	90 mm	130 mm	CTC-2159986	125.06
1772446			Bushing	90 mm		CTC-1140758	41.30
1772465			P-UB-10	105 mm	150 mm	CTC-1915619	162.21
1772465			Bushing	105 mm		CTC-1140760	54.85
<b>BKM1-UP</b>							
2043689			P-UB-10	85 mm	120 mm	CTC-2479001	148.20
2043689			Bushing	85 mm		CTC-0964402	33.54
<b>BKM1-UP; BLP1-UP</b>							
1772453			P-UB-10	90 mm	130 mm	CTC-1261887	427.68
1772453			Bushing	90 mm		CTC-1052575	32.35
1850346			P-UB-10	85 mm	120 mm	CTC-1540744	469.05
1850346			Bushing	85 mm		CTC-0964402	33.54
1915584			P-UB-10	90 mm	130 mm	CTC-2590626	140.30
1915584			Bushing	90 mm		CTC-1052575	32.35
2043621			P-UB-10	90 mm	130 mm	CTC-2590627	140.30
2043621			Bushing	90 mm		CTC-1052575	32.35
2043696			P-UB-10	85 mm	120 mm	CTC-2479000	148.20
2043696			Bushing	85 mm		CTC-0964402	33.54
2590705			P-UB-10	85 mm	120 mm	CTC-2590706	148.20
2590705			Bushing	85 mm		CTC-0964402	33.54
2590718			P-UB-10	90 mm	130 mm	CTC-2590719	141.98
2590718			Bushing	90 mm		CTC-1052575	32.35
2590746			P-UB-10	105 mm	150 mm	CTC-2590743	125.22
2590746			Bushing	105 mm		CTC-1140760	54.85
2897887			P-UB-10	90 mm	130 mm	CTC-2159986	125.06
2897887			Bushing	90 mm		CTC-1140758	41.30
<b>BKM1-UP; BLP1-UP; EMR1-UP; MAR1-UP</b>							
2478853			P-UB-10	105 mm	150 mm	CTC-1915619	162.21
2478853			Bushing	105 mm		CTC-1140760	54.85
<b>BKM243-UP; BLP180-UP</b>							
2043617			P-UB-10	85 mm	120 mm	CTC-2043627	139.85
2043617			Bushing	85 mm		CTC-0964402	33.54
<b>DAA1-UP; FED1-UP</b>							
2742521			P-UB-10	85 mm	120 mm	CTC-2742511	117.70
2742521			Bushing	85 mm		CTC-1140756	35.81
2742532			P-UB-10	90 mm	130 mm	CTC-2742526	124.86
2742532			Bushing	90 mm		CTC-1140758	41.30
<b>HEK1-UP</b>							
1709808			P-UB-10	65 mm	100 mm	CTC-1709941	129.73
1709808			Bushing	65 mm		CTC-1140754	24.80
<b>STICK</b>							
<b>BKJ1-UP</b>							
1169123			P-UB-10	105 mm	150 mm	CTC-1169123K	188.27
1169123			Bushing	105 mm		CTC-1140760	54.85
1772443			P-UB-10	100 mm	140 mm	CTC-1589093	122.51
<b>BKM1-UP</b>							
1169123			P-UB-10	105 mm	150 mm	CTC-1997416	206.20
1169123			Bushing	105 mm		CTC-1140760	54.85





## REPLACEMENT KITS FOR CATERPILLAR® EQUIPMENT

Excavators							
APPLICATION	CYL #	Misc-Parts, Instructions, etc.	CODE	ROD	BORE	KIT #	List \$
<b>MODEL 322C L</b>							
STICK							
BKM1-UP; BLP1-UP							
1915582			P-UB-10	100 mm	140 mm	CTC-2590631	154.13
1915582			Bushing	100 mm		CTC-0965625	49.93
2043620			P-UB-10	100 mm	140 mm	CTC-2590633	154.13
2043620			Bushing	100 mm		CTC-0965625	49.93
2590715			P-UB-10	100 mm	140 mm	CTC-2590699	154.13
2590715			Bushing	100 mm		CTC-0965625	49.93
BKM1-UP; BLP1-UP; EMR1-UP; MAR1-UP							
1772443			P-UB-10	100 mm	140 mm	CTC-2159985	122.51
1772443			Bushing	100 mm		CTC-1140757	50.34
DAA1-UP; EMR1-UP; FED1-UP; MAR1-UP							
2897884			P-UB-10	100 mm	140 mm	CTC-2478792	185.30
2897884			Bushing	100 mm		CTC-1140757	50.34
DAA1-UP; FED1-UP							
2742529			P-UB-10	100 mm	140 mm	CTC-2742515	169.37
2742529			Bushing	100 mm		CTC-1140757	50.34
HEK1-UP							
2166607			P-UB-10	105 mm	150 mm	CTC-1915619	162.21
2166607			Bushing	105 mm		CTC-1140760	54.85
<b>MODEL 322C LN</b>							
BOOM							
BFK1-UP; BGR1-UP							
6C9407			P-UB-10	100 mm	170 mm	CTC-2330763	224.74
6C9407			Bushing	100 mm		CTC-1140757	50.34
BFK1-UP; BGR1-UP; EMR1-UP; MAR1-UP							
1772440			P-UB-10	90 mm	130 mm	CTC-2159986	125.06
1772440			Bushing	90 mm		CTC-1140758	41.30
EMR1-UP; MAR1-UP							
2113069			P-UB-10	100 mm	170 mm	CTC-2519341	264.56
2113069			Bushing	100 mm		CTC-1140757	50.34
BUCKET							
BFK1-UP; BGR1-UP; EMR1-UP; MAR1-UP							
1772446			P-UB-10	90 mm	130 mm	CTC-2159986	125.06
1772446			Bushing	90 mm		CTC-1140758	41.30
1772465			P-UB-10	105 mm	150 mm	CTC-1915619	162.21
1772465			Bushing	105 mm		CTC-1140760	54.85
2478853			P-UB-10	105 mm	150 mm	CTC-1915619	162.21
2478853			Bushing	105 mm		CTC-1140760	54.85
STICK							
BFK1-UP; BGR1-UP; EMR1-UP; MAR1-UP							
1772443			P-UB-10	100 mm	140 mm	CTC-2159985	122.51
1772443			Bushing	100 mm		CTC-1140757	50.34
EMR1-UP; MAR1-UP							
2897884			P-UB-10	100 mm	140 mm	CTC-2478792	185.30
2897884			Bushing	100 mm		CTC-1140757	50.34
<b>MODEL 322L</b>							
BOOM							
1052571			P-UB-10	90 mm	130 mm	CTC-1052585	484.06
1052588			P-UB-10	100 mm	140 mm	CTC-1270630	340.15
711345			P-UB-10	90 mm	130 mm	CTC-711360	296.64
BUCKET							
1052597			P-UB-10	85 mm	130 mm	CTC-1052601	433.38
717291			P-UB-10	85 mm	130 mm	CTC-7Y5145	267.26
7Y5100			P-UB-10	85 mm	130 mm	CTC-7Y5145	267.26
7Y5150			P-UB-10	105 mm	150 mm	CTC-1163612	301.76
875633			P-UB-10	85 mm	120 mm	CTC-0875394	258.77

CATERPILLAR®



## REPLACEMENT KITS FOR CATERPILLAR® EQUIPMENT

Excavators							
APPLICATION	CYL #	Misc-Parts, Instructions, etc.	CODE	ROD	BORE	KIT #	List \$
<b>MODEL 322L</b>							
STICK							
	717341		P-UB-10	100 mm	140 mm	CTC-0875387	341.66
<b>MODEL 322N</b>							
BOOM							
	711345		P-UB-10	90 mm	130 mm	CTC-711360	296.64
BUCKET							
	717291		P-UB-10	85 mm	130 mm	CTC-7Y5145	267.26
	7Y5100		P-UB-10	85 mm	130 mm	CTC-7Y5145	267.26
	7Y5150		P-UB-10	105 mm	150 mm	CTC-1163612	301.76
STICK							
	717341		P-UB-10	100 mm	140 mm	CTC-0875387	341.66
<b>MODEL 324D L</b>							
BOOM							
BTK1-UP; JYG1-UP; LAB1-UP; PYT1-UP; SYM1-UP							
	2897957		P-UB-10	95 mm	135 mm	CTC-2344488	268.59
	2897957		Bushing	95 mm		CTC-1289260	42.86
DFP1-UP; JAT1-UP							
	2667981		P-UB-10	95 mm	135 mm	CTC-2668013	171.01
	2667981		Bushing	95 mm		CTC-0964430	36.43
	2667981		Link Pin Seal	90 mm		CTC-1661495	33.77
	2667981		Link Pin Seal	90 mm		CTC-7X4803	33.77
DFP1-UP; JAT1-UP; PYT1-UP							
	2426858		P-UB-10	95 mm	135 mm	CTC-2590665	171.01
	2426858		Bushing	95 mm		CTC-0964430	36.43
	2426858		Link Pin Seal	90 mm		CTC-1661495	33.77
	2426858		Link Pin Seal	90 mm		CTC-7X4803	33.77
	2426862		P-UB-10	100 mm	140 mm	CTC-2478974	196.88
	2426862		Bushing	100 mm		CTC-0965625	49.93
DFP1-UP; JAT1-UP; PYT1-UP; TSN1-UP							
	2426867		P-UB-10	95 mm	135 mm	CTC-2590774	166.04
	2426867		Bushing	95 mm		CTC-0964430	36.43
	2426867		Link Pin Seal	90 mm		CTC-1661495	33.77
	2426867		Link Pin Seal	90 mm		CTC-7X4803	33.77
JYG1-UP; LAB1-UP; SYM1-UP							
	2426849		P-UB-10	95 mm	135 mm	CTC-2344488	268.59
	2426849		Bushing	95 mm		CTC-1289260	42.86
BUCKET							
BTK1-UP; JYG1-UP; LAB1-UP; PYT1-UP; SYM1-UP							
	2897975		P-UB-10	90 mm	130 mm	CTC-2159986	125.06
	2897975		Bushing	90 mm		CTC-1140758	41.30
	3154451		P-UB-10	105 mm	150 mm	CTC-1915619	162.21
	3154451		Bushing	105 mm		CTC-1140760	54.85
DFP1-UP							
	3494134		P-UB-10	85 mm	120 mm	CTC-3500967	227.56
	3494134		Bushing	85 mm		CTC-0964402	33.54
DFP1-UP; JAT1-UP							
	2667985		P-UB-10	90 mm	130 mm	CTC-2668014	443.80
	2667985		Bushing	90 mm		CTC-1052575	32.35
	2897699		P-UB-10	70 mm	100 mm	CTC-2836179	194.23
	2897699		Bushing	70 mm		CTC-1140753	28.52
DFP1-UP; JAT1-UP; PYT1-UP							
	2426756		P-UB-10	85 mm	120 mm	CTC-2478888	137.02
	2426756		Bushing	85 mm		CTC-0964402	33.54
	2426759		P-UB-10	85 mm	120 mm	CTC-2667892	137.02
	2426759		Bushing	85 mm		CTC-0964402	33.54
	2426864		P-UB-10	90 mm	130 mm	CTC-2590678	130.20
	2426864		Bushing	90 mm		CTC-1052575	32.35

**CATERPILLAR®**



## REPLACEMENT KITS FOR CATERPILLAR® EQUIPMENT

Excavators							
APPLICATION	CYL #	Misc-Parts, Instructions, etc.	CODE	ROD	BORE	KIT #	List \$
<b>MODEL 324D L</b>							
<b>BUCKET</b>							
DFP1-UP; JAT1-UP; PYT1-UP; SYM1-UP							
3154442			P-UB-10	105 mm	150 mm	CTC-1915619	162.21
3154442			Bushing	105 mm		CTC-1140760	54.85
DFP1-UP; JAT1-UP; PYT1-UP; TSN1-UP							
2426871			P-UB-10	90 mm	130 mm	CTC-2590776	304.21
2426871			Bushing	90 mm		CTC-1052575	32.35
3154449			P-UB-10	105 mm	150 mm	CTC-2502475	136.08
3154449			Bushing	105 mm		CTC-1140760	54.85
DFP1-UP; JGG1-UP							
2487855			P-UB-10	65 mm	100 mm	CTC-1709941	129.73
2487855			Bushing	65 mm		CTC-1140754	24.80
2836118			P-UB-10	65 mm	100 mm	CTC-1709941	129.73
2836118			Bushing	65 mm		CTC-1140754	24.80
JGG1-UP							
2426767			P-UB-10	85 mm	120 mm	CTC-2478790	109.57
2426767			Bushing	85 mm		CTC-1140756	35.81
JGG1-UP; LAB1-UP; SYM1-UP							
2426855			P-UB-10	90 mm	130 mm	CTC-2426855K	115.57
2426855			Bushing	90 mm		CTC-1140758	41.30
2898012			P-UB-10	105 mm	150 mm	CTC-1915619	162.21
2898012			Bushing	105 mm		CTC-1140760	54.85
JGG1-UP; PYT1-UP							
2897948			P-UB-10	85 mm	120 mm	CTC-2478790	109.57
2897948			Bushing	85 mm		CTC-1140756	35.81
JGG1-UP; SYM1-UP							
2254581			P-UB-10	105 mm	150 mm	CTC-1915619	162.21
2254581			Bushing	105 mm		CTC-1140760	54.85
PYT1-UP							
2898086			P-UB-10	70 mm	100 mm	CTC-2836179	194.23
2898086			Bushing	70 mm		CTC-1140753	28.52
<b>CAB RISER</b>							
DFP1-UP							
2358287			P-UB-14	60 mm	90 mm	CTC-1697827	206.73
2358287			Bushing	60 mm		CTC-1140751	23.38
<b>COUPLER</b>							
BTK1-UP; SYM1-UP							
1690753			P-U-5	40 mm	70 mm	CTC-2191322	34.53
SYM1-UP							
1690329			I-U-5	40 mm	60 mm	CTC-2027897	41.35
<b>FORE BOOM</b>							
SYM1-UP							
2798111			P-UB-10	100 mm	170 mm	CTC-2519341	264.56
2798111			Bushing	100 mm		CTC-1140757	50.34
<b>STICK</b>							
BTK1-UP; JGG270-UP; LAB1-UP; SYM1-UP							
2897967			P-UB-10	100 mm	140 mm	CTC-2478792	185.30
2897967			Bushing	100 mm		CTC-1140757	50.34
DFP1-UP; JAT1-UP							
2667983			P-UB-10	100 mm	140 mm	CTC-2668012	196.88
2667983			Bushing	100 mm		CTC-0965625	49.93
DFP1-UP; JAT1-UP; JGG1-UP; PYT-UP							
2166607			P-UB-10	105 mm	150 mm	CTC-1915619	162.21
2166607			Bushing	105 mm		CTC-1140760	54.85
DFP1-UP; JAT1-UP; PYT1-UP							
2426860			P-UB-10	100 mm	140 mm	CTC-2478878	196.88
2426860			Bushing	100 mm		CTC-0965625	49.93

**CATERPILLAR®**



## REPLACEMENT KITS FOR CATERPILLAR® EQUIPMENT

Excavators							
APPLICATION	CYL #	Misc-Parts, Instructions, etc.	CODE	ROD	BORE	KIT #	List \$
<b>MODEL 324D L</b>							
STICK							
		DFP1-UP; JAT1-UP; PYT1-UP; TSN1-UP					
2426869			P-UB-10	100 mm	140 mm	CTC-2590775	196.88
2426869			Bushing	100 mm		CTC-0965625	49.93
		JYG1-UP; LAB1-UP; SYM1-UP					
2426852			P-UB-10	100 mm	140 mm	CTC-2478792	185.30
2426852			Bushing	100 mm		CTC-1140757	50.34
<b>MODEL 325</b>							
BOOM							
7Y4601			P-UB-10	95 mm	130 mm	CTC-7Y5147	298.89
BUCKET							
0875491			P-UB-10	85 mm	120 mm	CTC-4I3665	313.01
0875633			P-UB-10	85 mm	120 mm	CTC-0875394	258.77
0875633			P-UB-10	85 mm	120 mm	CTC-1184131	249.86
1072614			P-UB-10	85 mm	130 mm	CTC-7Y5145	267.26
1346987			P-UB-10	65 mm	100 mm	CTC-1764935	221.28
4I7652			P-UB-10	65 mm	100 mm	CTC-4I7664	204.47
4I8840			P-UB-10	65 mm	100 mm	CTC-4I8914	204.39
7I7291			P-UB-10	85 mm	130 mm	CTC-7Y5145	267.26
7Y5100			P-UB-10	85 mm	130 mm	CTC-7Y5145	267.26
7Y5150			P-UB-10	105 mm	150 mm	CTC-1163612	301.76
STICK							
7Y4650			P-UB-10	105 mm	150 mm	CTC-1163612	301.76
7Y4926			P-UB-10	110 mm	170 mm	CTC-1163649	376.59
<b>MODEL 325B, 325BL</b>							
BOOM							
1077040			P-UB-10	100 mm	140 mm	CTC-1373766	309.80
1140636			P-UB-10	100 mm	140 mm	CTC-1184024	325.48
1169123			P-UB-10	105 mm	150 mm	CTC-1163612	301.76
1232081			P-UB-10	105 mm	150 mm	CTC-1373767	418.82
1540760			P-UB-10	100 mm	140 mm	CTC-1540761	382.25
BUCKET							
1183921			P-UB-10	105 mm	150 mm	CTC-1163612	301.76
1183921			P-UB-10	105 mm	150 mm	CTC-1680758	349.00
1184134			P-UB-10	85 mm	120 mm	CTC-1184131	249.86
1232044			P-UB-10	90 mm	130 mm	CTC-1184175	295.27
1232044	325BL Only		P-UB-10	90 mm	130 mm	CTC-1764914	141.89
1232084			P-UB-10	90 mm	130 mm	CTC-1373768	440.48
1336810			P-UB-10	105 mm	150 mm	CTC-1289277	367.94
1497610			P-UB-10	90 mm	130 mm	CTC-1184175	295.27
1540756			P-UB-10	90 mm	130 mm	CTC-1540757	448.38
1540772			P-UB-10	90 mm	130 mm	CTC-1540773	448.08
4I1726			P-UB-10	110 mm	160 mm	CTC-0876654	320.96
4I7652			P-UB-10	65 mm	100 mm	CTC-4I7664	204.47
4I8840			P-UB-10	65 mm	100 mm	CTC-4I8914	204.39
STICK							
0875375			P-UB-10	130 mm	180 mm	CTC-0875407	398.13
1163638			P-UB-10	110 mm	170 mm	CTC-1680759	400.71
1184000			P-UB-10	105 mm	150 mm	CTC-1163612	301.76
1184000			P-UB-10	105 mm	150 mm	CTC-1680758	349.00
1232081			P-UB-10	105 mm	150 mm	CTC-1373767	418.82
1479427			P-UB-10	105 mm	150 mm	CTC-1680758	349.00
1540765			P-UB-10	105 mm	150 mm	CTC-1540766	392.44
7Y4650			P-UB-10	105 mm	150 mm	CTC-7Y4698	336.22

**CATERPILLAR®**



## REPLACEMENT KITS FOR CATERPILLAR® EQUIPMENT

Excavators							
APPLICATION	CYL #	Misc-Parts, Instructions, etc.	CODE	ROD	BORE	KIT #	List \$
<b>MODEL 325C</b>							
<b>BOOM</b>							
AMH1-UP; BKW1-UP; BMM1-UP; BTD1-UP							
2096006			P-UB-10	100 mm	140 mm	CTC-2590634	151.26
2096006			Bushing	100 mm		CTC-0965625	49.93
BKW1-UP; BMM1-UP							
1799789			P-UB-10	100 mm	140 mm	CTC-1336823	321.13
1799789			Bushing	100 mm		CTC-0965625	49.93
1915587			P-UB-10	100 mm	140 mm	CTC-2590632	151.26
1915587			Bushing	100 mm		CTC-0965625	49.93
2590724			P-UB-10	100 mm	140 mm	CTC-2590725	151.26
2590724			Bushing	100 mm		CTC-0965625	49.93
JLC1-UP							
2033906			P-UB-10	105 mm	150 mm	CTC-1915619	162.21
2033906			Bushing	105 mm		CTC-1140760	54.85
JLC1-UP; JLD1-UP							
1799782			P-UB-10	100 mm	140 mm	CTC-2159985	122.51
1799782			Bushing	100 mm		CTC-1140757	50.34
1915548			P-UB-10	105 mm	150 mm	CTC-1915619	162.21
1915548			Bushing	105 mm		CTC-1140760	54.85
2113069			P-UB-10	100 mm	170 mm	CTC-2519341	264.56
2113069			Bushing	100 mm		CTC-1140757	50.34
2502419			P-UB-10	105 mm	150 mm	CTC-2426840	175.50
2502419			Bushing	105 mm		CTC-1140760	54.85
<b>BUCKET</b>							
AMH1-UP; BKW1-UP; BMM1-UP; BTD1-UP							
2096011			P-UB-10	90 mm	130 mm	CTC-2590627	140.30
2096011			Bushing	90 mm		CTC-1052575	32.35
AMH1-UP; BTD1-UP; JLC1-UP; JLD1-UP							
1772465			P-UB-10	105 mm	150 mm	CTC-1915619	162.21
1772465			Bushing	105 mm		CTC-1140760	54.85
2478853			P-UB-10	105 mm	150 mm	CTC-1915619	162.21
2478853			Bushing	105 mm		CTC-1140760	54.85
BKW1-UP; BMM1-UP							
1799793			P-UB-10	90 mm	130 mm	CTC-2590626	140.30
1799793			Bushing	90 mm		CTC-1052575	32.35
1948276			P-UB-10	105 mm	150 mm	CTC-2003315	162.21
1948276			Bushing	105 mm		CTC-1140760	54.85
2478854			P-UB-10	105 mm	150 mm	CTC-2502475	136.08
2478854			Bushing	105 mm		CTC-1140760	54.85
2590732			P-UB-10	90 mm	130 mm	CTC-2590719	141.98
2590732			Bushing	90 mm		CTC-1052575	32.35
JLC1-UP							
2201532			P-UB-10	100 mm	140 mm	CTC-2159985	122.51
2201532			Bushing	100 mm		CTC-1140757	50.34
JLC1-UP; JLD1-UP							
1799764			P-UB-10	90 mm	130 mm	CTC-2159986	125.06
1799764			Bushing	90 mm		CTC-1140758	41.30
<b>STICK</b>							
AMH1-UP; BKW1-UP; BMM1-UP; BTD1-UP							
1799791			P-UB-10	105 mm	150 mm	CTC-1799791K	339.96
1799791			Bushing	105 mm		CTC-0995572	42.95
2096008			P-UB-10	105 mm	150 mm	CTC-2590637	344.01
2096008			Bushing	105 mm		CTC-0995572	42.95

**CATERPILLAR®**



## REPLACEMENT KITS FOR CATERPILLAR® EQUIPMENT

Excavators							
APPLICATION	CYL #	Misc-Parts, Instructions, etc.	CODE	ROD	BORE	KIT #	List \$
<b>MODEL 325C</b>							
<b>STICK</b>							
BKW1-UP; BMM1-UP							
1915589			P-UB-10	105 mm	150 mm	CTC-2590636	344.01
1915589			Bushing	105 mm		CTC-0995572	42.95
2590728			P-UB-10	105 mm	150 mm	CTC-2590729	344.01
2590728			Bushing	105 mm		CTC-0995572	42.95
JLC1-UP							
2044907			P-UB-10	95 mm	160 mm	CTC-2521191	195.29
2044907			Bushing	95 mm		CTC-6C6093	46.13
JLC1-UP; JLD1-UP							
1799785		Type 1	P-UB-10	105 mm	150 mm	CTC-1915619	162.21
1799785		Type 2	P-UB-10	105 mm	150 mm	CTC-2426840	175.50
1799785		Type 1 and Type 2	Bushing	105 mm		CTC-1140760	54.85
1915551			P-UB-10	115 mm	170 mm	CTC-2316844	317.73
<b>MODEL 325C L</b>							
<b>BOOM</b>							
AMH1-UP; BKW1-UP; BMM1-UP; BTD1-UP							
2096006			P-UB-10	100 mm	140 mm	CTC-2590634	151.26
2096006			Bushing	100 mm		CTC-0965625	49.93
BFE1-UP; CRB1-UP; CSJ1-UP; JLC1-UP; JLD1-UP							
1799782			P-UB-10	100 mm	140 mm	CTC-2159985	122.51
1799782			Bushing	100 mm		CTC-1140757	50.34
BKW1-UP; BMM1-UP							
1799789			P-UB-10	100 mm	140 mm	CTC-1336823	321.13
1799789			Bushing	100 mm		CTC-0965625	49.93
1915587			P-UB-10	100 mm	140 mm	CTC-2590632	151.26
1915587			Bushing	100 mm		CTC-0965625	49.93
2590724			P-UB-10	100 mm	140 mm	CTC-2590725	151.26
2590724			Bushing	100 mm		CTC-0965625	49.93
CRB1-UP; CSJ1-UP; JLC1-UP; JLD1-UP							
2113069			P-UB-10	100 mm	170 mm	CTC-2519341	264.56
2113069			Bushing	100 mm		CTC-1140757	50.34
JLC1-UP							
2033906			P-UB-10	105 mm	150 mm	CTC-1915619	162.21
2033906			Bushing	105 mm		CTC-1140760	54.85
JLC1-UP; JLD1-UP							
1915548			P-UB-10	105 mm	150 mm	CTC-1915619	162.21
1915548			Bushing	105 mm		CTC-1140760	54.85
2502419			P-UB-10	105 mm	150 mm	CTC-2426840	175.50
2502419			Bushing	105 mm		CTC-1140760	54.85
<b>BUCKET</b>							
AMH1-UP; BFE1-UP; BTD1-UP; CRB1-UP; CSJ1-UP; JLC1-UP; JLD1-UP							
1772465			P-UB-10	105 mm	150 mm	CTC-1915619	162.21
1772465			Bushing	105 mm		CTC-1140760	54.85
AMH1-UP; BKW1-UP; BMM1-UP; BTD1-UP							
2096011			P-UB-10	90 mm	130 mm	CTC-2590627	140.30
2096011			Bushing	90 mm		CTC-1052575	32.35
AMH1-UP; BTD1-UP; CRB1-UP; CSJ1-UP; JLC1-UP; JLD1-UP							
2478853			P-UB-10	105 mm	150 mm	CTC-1915619	162.21
2478853			Bushing	105 mm		CTC-1140760	54.85
BFE1-UP							
1589061			P-U-10	85 mm	120 mm	CTC-2366389	109.57
1589061			Bushing	85 mm		CTC-1140756	35.81
1799764			P-UB-10	90 mm	130 mm	CTC-1799764K	125.06
1799764			Bushing	90 mm		CTC-1140758	41.30

**CATERPILLAR®**



## REPLACEMENT KITS FOR CATERPILLAR® EQUIPMENT

Excavators							
APPLICATION	CYL #	Misc-Parts, Instructions, etc.	CODE	ROD	BORE	KIT #	List \$
<b>MODEL 325C L</b>							
<b>BUCKET</b>							
BKW1-UP; BMM1-UP							
1799793			P-UB-10	90 mm	130 mm	CTC-2590626	140.30
1799793			Bushing	90 mm		CTC-1052575	32.35
1948276			P-UB-10	105 mm	150 mm	CTC-2003315	162.21
1948276			Bushing	105 mm		CTC-1140760	54.85
2478854			P-UB-10	105 mm	150 mm	CTC-2502475	136.08
2478854			Bushing	105 mm		CTC-1140760	54.85
2590732			P-UB-10	90 mm	130 mm	CTC-2590719	141.98
2590732			Bushing	90 mm		CTC-1052575	32.35
CRB1-UP							
1709808			P-UB-10	65 mm	100 mm	CTC-1709941	129.73
1709808			Bushing	65 mm		CTC-1140754	24.80
2959396			P-UB-10	65 mm	100 mm	CTC-1709941	129.73
2959396			Bushing	65 mm		CTC-1140754	24.80
CRB1-UP; CSJ1-UP; JLC1-UP; JLD1-UP							
1799764			P-UB-10	90 mm	130 mm	CTC-2159986	125.06
1799764			Bushing	90 mm		CTC-1140758	41.30
JLC1-UP							
2201532			P-UB-10	100 mm	140 mm	CTC-2159985	122.51
2201532			Bushing	100 mm		CTC-1140757	50.34
<b>QUICK COUPLER</b>							
BFE1-UP; CRB1-UP							
1728403			I-U-14	50 mm	100 mm	CTC-2525507	159.23
<b>STICK</b>							
AMH1-UP; BKW1-UP; BMM1-UP; BTD1-UP							
1799791			P-UB-10	105 mm	150 mm	CTC-1799791K	339.96
1799791			Bushing	105 mm		CTC-0995572	42.95
2096008			P-UB-10	105 mm	150 mm	CTC-2590637	344.01
2096008			Bushing	105 mm		CTC-0995572	42.95
BFE1-UP							
1799785			P-UB-10	105 mm	150 mm	CTC-1799785K	175.50
1799785			Bushing	105 mm		CTC-1140760	54.85
BKW1-UP; BMM1-UP							
1915589			P-UB-10	105 mm	150 mm	CTC-2590636	344.01
1915589			Bushing	105 mm		CTC-0995572	42.95
2590728			P-UB-10	105 mm	150 mm	CTC-2590729	344.01
2590728			Bushing	105 mm		CTC-0995572	42.95
CRB1-UP; CSJ1-UP							
2188124			P-UB-10	105 mm	150 mm	CTC-1884219	162.21
2188124			Bushing	105 mm		CTC-1140760	54.85
CRB1-UP; CSJ1-UP; JLC1-UP; JLD1-UP							
1799785	Type 1		P-UB-10	105 mm	150 mm	CTC-1915619	162.21
1799785	Type 2		P-UB-10	105 mm	150 mm	CTC-2426840	175.50
1799785	Type 1 and Type 2		Bushing	105 mm		CTC-1140760	54.85
JLC1-UP							
2044907			P-UB-10	95 mm	160 mm	CTC-2521191	195.29
2044907			Bushing	95 mm		CTC-6C6093	46.13
JLC1-UP; JLD1-UP							
1915551			P-UB-10	115 mm	170 mm	CTC-2316844	317.73
<b>MODEL 325C LN</b>							
<b>BOOM</b>							
CRB1-UP; CSJ1-UP							
1799782			P-UB-10	100 mm	140 mm	CTC-2159985	122.51
1799782			Bushing	100 mm		CTC-1140757	50.34
2113069			P-UB-10	100 mm	170 mm	CTC-2519341	264.56
2113069			Bushing	100 mm		CTC-1140757	50.34

CATERPILLAR®





## REPLACEMENT KITS FOR CATERPILLAR® EQUIPMENT

Excavators							
APPLICATION	CYL #	Misc-Parts, Instructions, etc.	CODE	ROD	BORE	KIT #	List \$
<b>MODEL 325C LN</b>							
BUCKET							
CRB1-UP							
1709808			P-UB-10	65 mm	100 mm	CTC-1709941	129.73
1709808			Bushing	65 mm		CTC-1140754	24.80
2959396			P-UB-10	65 mm	100 mm	CTC-1709941	129.73
2959396			Bushing	65 mm		CTC-1140754	24.80
CRB1-UP; CSJ1-UP							
1772465			P-UB-10	105 mm	150 mm	CTC-1915619	162.21
1772465			Bushing	105 mm		CTC-1140760	54.85
1799764			P-UB-10	90 mm	130 mm	CTC-2159986	125.06
1799764			Bushing	90 mm		CTC-1140758	41.30
2478853			P-UB-10	105 mm	150 mm	CTC-1915619	162.21
2478853			Bushing	105 mm		CTC-1140760	54.85
QUICK COUPLER							
CRB1-UP							
1728403			I-U-14	50 mm	100 mm	CTC-2525507	159.23
STICK							
CRB1-UP; CSJ1-UP							
1799785	Type 1		P-UB-10	105 mm	150 mm	CTC-1915619	162.21
1799785	Type 2		P-UB-10	105 mm	150 mm	CTC-2426840	175.50
1799785	Type 1 and Type 2		Bushing	105 mm		CTC-1140760	54.85
2188124			P-UB-10	105 mm	150 mm	CTC-1884219	162.21
2188124			Bushing	105 mm		CTC-1140760	54.85
<b>MODEL 325D</b>							
BOOM							
DBH1-UP; KBE1-UP; KDG1-UP; SCR1-UP							
2254584			P-UB-10	100 mm	140 mm	CTC-2344566	146.21
2254584			Bushing	100 mm		CTC-0965625	49.93
KDG1-UP; SCR1-UP							
2254595			P-UB-10	100 mm	140 mm	CTC-2590648	146.21
2254595			Bushing	100 mm		CTC-0965625	49.93
2667988			P-UB-10	100 mm	140 mm	CTC-2668015	139.68
2667988			Bushing	100 mm		CTC-0965625	49.93
BUCKET							
AZP1-UP; DBH1-UP; KBE1-UP; KDG1-UP; SCR1-UP							
2254581			P-UB-10	105 mm	150 mm	CTC-1915619	162.21
2254581			Bushing	105 mm		CTC-1140760	54.85
DBH1-UP; KBE1-UP; KDG1-UP; SCR1-UP							
2254591			P-UB-10	95 mm	135 mm	CTC-2344587	134.16
2254591			Bushing	95 mm		CTC-0964430	36.43
KDG1-UP; SCR1-UP							
2254599			P-UB-10	95 mm	135 mm	CTC-2590656	132.85
2254599			Bushing	95 mm		CTC-0964430	36.43
2254602			P-UB-10	105 mm	150 mm	CTC-2502475	136.08
2254602			Bushing	105 mm		CTC-1140760	54.85
2667992			P-UB-10	95 mm	135 mm	CTC-2668045	134.16
2667992			Bushing	95 mm		CTC-0964430	36.43
2668080			P-UB-10	105 mm	150 mm	CTC-2590743	125.22
2668080			Bushing	105 mm		CTC-1140760	54.85
STICK							
DBH1-UP; KBE1-UP; KDG1-UP; SCR1-UP							
2254588			P-UB-10	105 mm	150 mm	CTC-2344576	335.81
2254588			Bushing	105 mm		CTC-0995572	42.95
2590778			P-UB-10	105 mm	150 mm	CTC-2590779	320.70
2590778			Bushing	105 mm		CTC-0995572	42.95



## REPLACEMENT KITS FOR CATERPILLAR® EQUIPMENT

Excavators							
APPLICATION	CYL #	Misc-Parts, Instructions, etc.	CODE	ROD	BORE	KIT #	List \$
<b>MODEL 325D</b>							
<b>STICK</b>							
KDG1-UP; SCR1-UP							
2254597			P-UB-10	105 mm	150 mm	CTC-2590650	335.81
2254597			Bushing	105 mm		CTC-0995572	42.95
2667990			P-UB-10	105 mm	150 mm	CTC-2668016	335.81
2667990			Bushing	105 mm		CTC-0995572	42.95
<b>MODEL 325D L</b>							
<b>BOOM</b>							
A3R1-UP; GBR1-UP; GPB1-UP; JCL1-UP; MCL1-UP; PAL1-UP; PKE1-UP; T2S1-UP							
2254572			P-UB-10	100 mm	140 mm	CTC-2159985	122.51
2254572			Bushing	100 mm		CTC-1140757	50.34
A3R1-UP; GBR1-UP; GPB1-UP; PKE1-UP							
2959400			P-UB-10	100 mm	140 mm	CTC-2478792	185.30
2959400			Bushing	100 mm		CTC-1140757	50.34
DBH1-UP; KBE1-UP; KDG1-UP; SCR1-UP							
2254584			P-UB-10	100 mm	140 mm	CTC-2344566	146.21
2254584			Bushing	100 mm		CTC-0965625	49.93
GBR1-UP							
2033906			P-UB-10	105 mm	150 mm	CTC-1915619	162.21
2033906			Bushing	105 mm		CTC-1140760	54.85
2795614			P-UB-10	95 mm	160 mm	CTC-2521191	195.29
2795614			Bushing	95 mm		CTC-6C6093	46.13
GBR1-UP; GPB1-UP; LAL1-UP; MCL1-UP; NAC1-UP; PAL1-UP; PKE1-UP; T2S1-UP							
2959398			P-UB-10	100 mm	140 mm	CTC-2478792	185.30
2959398			Bushing	100 mm		CTC-1140757	50.34
GBR1-UP; GPB1-UP; LAL1-UP; MCL1-UP; PKE1-UP; T2S1-UP							
2798111			P-UB-10	100 mm	170 mm	CTC-2519341	264.56
2798111			Bushing	100 mm		CTC-1140757	50.34
KDG1-UP; SCR1-UP							
2254595			P-UB-10	100 mm	140 mm	CTC-2590648	146.21
2254595			Bushing	100 mm		CTC-0965625	49.93
2667988			P-UB-10	100 mm	140 mm	CTC-2668015	139.68
2667988			Bushing	100 mm		CTC-0965625	49.93
<b>BUCKET</b>							
A3R1-UP							
2487855			P-UB-10	65 mm	100 mm	CTC-1709941	129.73
2487855			Bushing	65 mm		CTC-1140754	24.80
2836118			P-UB-10	65 mm	100 mm	CTC-1709941	129.73
2836118			Bushing	65 mm		CTC-1140754	24.80
A3R1-UP; AZP1-UP; DBH1-UP; GBR1-UP; GPB1-UP; KBE1-UP; KDG1-UP; MCL1-UP; PKE1-UP; SCR1-UP; T2S1-UP							
2254581			P-UB-10	105 mm	150 mm	CTC-1915619	162.21
2254581			Bushing	105 mm		CTC-1140760	54.85
A3R1-UP; GBR1-UP; GPB1-UP; JCL1-UP; MCL1-UP; PAL1-UP; PKE1-UP; T2S1-UP							
2254578			P-UB-10	95 mm	135 mm	CTC-2344488	268.59
2254578			Bushing	95 mm		CTC-1289260	42.86
A3R1-UP; GBR1-UP; GPB1-UP; LAL1-UP; MCL1-UP; NAC1-UP; PAL1-UP; PKE1-UP							
2898004			P-UB-10	95 mm	135 mm	CTC-2344488	268.59
2898004			Bushing	95 mm		CTC-1289260	42.86
A3R1-UP; GBR1-UP; GPB1-UP; LAL1-UP; MCL1-UP; NAC1-UP; PAL1-UP; PKE1-UP; T2S1-UP							
2898012			P-UB-10	105 mm	150 mm	CTC-1915619	162.21
2898012			Bushing	105 mm		CTC-1140760	54.85
DBH1-UP; KBE1-UP; KDG1-UP; SCR1-UP							
2254591			P-UB-10	95 mm	135 mm	CTC-2344587	134.16
2254591			Bushing	95 mm		CTC-0964430	36.43

CATERPILLAR®



## REPLACEMENT KITS FOR CATERPILLAR® EQUIPMENT

### Excavators

APPLICATION	CYL #	Misc-Parts, Instructions, etc.	CODE	ROD	BORE	KIT #	List \$
<b>MODEL 325D L</b>							
<b>BUCKET</b>							
<b>GBR1-UP</b>							
2201532			P-UB-10	100 mm	140 mm	CTC-2159985	122.51
2201532			Bushing	100 mm		CTC-1140757	50.34
2897948			P-UB-10	85 mm	120 mm	CTC-2478790	109.57
2897948			Bushing	85 mm		CTC-1140756	35.81
<b>GBR1-UP; GPB1-UP; MCL1-UP; PKE1-UP</b>							
2426767			P-UB-10	85 mm	120 mm	CTC-2478790	109.57
2426767			Bushing	85 mm		CTC-1140756	35.81
<b>GPB1-UP</b>							
2959396			P-UB-10	65 mm	100 mm	CTC-1709941	129.73
2959396			Bushing	65 mm		CTC-1140754	24.80
3095975			P-UB-10	65 mm	100 mm	CTC-1709941	129.73
3095975			Bushing	65 mm		CTC-1140754	24.80
<b>KDG1-UP; SCR1-UP</b>							
2254599			P-UB-10	95 mm	135 mm	CTC-2590656	132.85
2254599			Bushing	95 mm		CTC-0964430	36.43
2254602			P-UB-10	105 mm	150 mm	CTC-2502475	136.08
2254602			Bushing	105 mm		CTC-1140760	54.85
2667992			P-UB-10	95 mm	135 mm	CTC-2668045	134.16
2667992			Bushing	95 mm		CTC-0964430	36.43
2668080			P-UB-10	105 mm	150 mm	CTC-2590743	125.22
2668080			Bushing	105 mm		CTC-1140760	54.85
<b>STICK</b>							
<b>A3R1-UP</b>							
2166607			P-UB-10	105 mm	150 mm	CTC-1915619	162.21
2166607			Bushing	105 mm		CTC-1140760	54.85
<b>A3R1-UP; GBR1-UP; GPB1-UP; JCL1-UP; MCL1-UP; PAL1-UP; PKE1-UP; T2S1-UP</b>							
2254575			P-UB-10	105 mm	150 mm	CTC-2426840	175.50
2254575			Bushing	105 mm		CTC-1140760	54.85
<b>A3R1-UP; GBR1-UP; GPB1-UP; LAL1-UP; MCL1-UP; NAC1-UP; PAL1-UP; PKE1-UP; T2S1-UP</b>							
2897994			P-UB-10	105 mm	150 mm	CTC-2426840	175.50
2897994			Bushing	105 mm		CTC-1140760	54.85
<b>DBH1-UP; KBE1-UP; KDG1-UP; SCR1-UP</b>							
2254588			P-UB-10	105 mm	150 mm	CTC-2344576	335.81
2254588			Bushing	105 mm		CTC-0995572	42.95
2590778			P-UB-10	105 mm	150 mm	CTC-2590779	320.70
2590778			Bushing	105 mm		CTC-0995572	42.95
<b>GBR1-UP</b>							
2344601			P-UB-10	115 mm	170 mm	CTC-2316844	317.73
2836188			P-UB-10	115 mm	170 mm	CTC-2316844	317.73
2898031			P-UB-10	115 mm	170 mm	CTC-2316844	317.73
<b>KDG1-UP; SCR1-UP</b>							
2254597			P-UB-10	105 mm	150 mm	CTC-2590650	335.81
2254597			Bushing	105 mm		CTC-0995572	42.95
2667990			P-UB-10	105 mm	150 mm	CTC-2668016	335.81
2667990			Bushing	105 mm		CTC-0995572	42.95

**CATERPILLAR®**



## REPLACEMENT KITS FOR CATERPILLAR® EQUIPMENT

Excavators							
APPLICATION	CYL #	Misc-Parts, Instructions, etc.	CODE	ROD	BORE	KIT #	List \$
<b>MODEL 325D LN</b>							
BOOM							
GPB1-UP; PKE1-UP							
	2254572		P-UB-10	100 mm	140 mm	CTC-2159985	122.51
	2254572		Bushing	100 mm		CTC-1140757	50.34
	2798111		P-UB-10	100 mm	170 mm	CTC-2519341	264.56
	2798111		Bushing	100 mm		CTC-1140757	50.34
	2959398		P-UB-10	100 mm	140 mm	CTC-2478792	185.30
	2959398		Bushing	100 mm		CTC-1140757	50.34
	2959400		P-UB-10	100 mm	140 mm	CTC-2478792	185.30
	2959400		Bushing	100 mm		CTC-1140757	50.34
BUCKET							
GPB1-UP							
	2959396		P-UB-10	65 mm	100 mm	CTC-1709941	129.73
	2959396		Bushing	65 mm		CTC-1140754	24.80
	3095975		P-UB-10	65 mm	100 mm	CTC-1709941	129.73
	3095975		Bushing	65 mm		CTC-1140754	24.80
GPB1-UP; PKE1-UP							
	2254578		P-UB-10	95 mm	135 mm	CTC-2344488	268.59
	2254578		Bushing	95 mm		CTC-1289260	42.86
	2254581		P-UB-10	105 mm	150 mm	CTC-1915619	162.21
	2254581		Bushing	105 mm		CTC-1140760	54.85
	2426767		P-UB-10	85 mm	120 mm	CTC-2478790	109.57
	2426767		Bushing	85 mm		CTC-1140756	35.81
	2898004		P-UB-10	95 mm	135 mm	CTC-2344488	268.59
	2898004		Bushing	95 mm		CTC-1289260	42.86
	2898012		P-UB-10	105 mm	150 mm	CTC-1915619	162.21
	2898012		Bushing	105 mm		CTC-1140760	54.85
STICK							
GPB1-UP; PKE1-UP							
	2254575		P-UB-10	105 mm	150 mm	CTC-2426840	175.50
	2254575		Bushing	105 mm		CTC-1140760	54.85
	2897994		P-UB-10	105 mm	150 mm	CTC-2426840	175.50
	2897994		Bushing	105 mm		CTC-1140760	54.85
<b>MODEL 325L</b>							
BOOM							
	7Y4601		P-UB-10	95 mm	130 mm	CTC-7Y5147	298.89
BUCKET							
	1251547		P-UB-10	65 mm	100 mm	CTC-4I8914	204.39
	4I7652		P-UB-10	65 mm	100 mm	CTC-4I7664	204.47
	4I8840		P-UB-10	65 mm	100 mm	CTC-4I8914	204.39
	7I7291		P-UB-10	85 mm	130 mm	CTC-7Y5145	267.26
	7Y5100		P-UB-10	85 mm	130 mm	CTC-7Y5145	267.26
	7Y5150		P-UB-10	105 mm	150 mm	CTC-1163612	301.76
	875633		P-UB-10	85 mm	120 mm	CTC-0875394	258.77
STICK							
	1169123		P-UB-10	105 mm	150 mm	CTC-1163612	301.76
	7Y4650		P-UB-10	105 mm	150 mm	CTC-1163612	301.76
<b>MODEL 325N</b>							
BOOM							
	7Y4601		P-UB-10	95 mm	130 mm	CTC-7Y5147	298.89
BUCKET							
	7Y5100		P-UB-10	85 mm	130 mm	CTC-7Y5145	267.26
	7Y5150		P-UB-10	105 mm	150 mm	CTC-1163612	301.76
	875633		P-UB-10	85 mm	120 mm	CTC-0875394	258.77
STICK							
	7Y4650		P-UB-10	105 mm	150 mm	CTC-1163612	301.76

CATERPILLAR®



## REPLACEMENT KITS FOR CATERPILLAR® EQUIPMENT

Excavators							
APPLICATION	CYL #	Misc-Parts, Instructions, etc.	CODE	ROD	BORE	KIT #	List \$
<b>MODEL 330</b>							
BOOM							
	7Y4906		P-UB-10	105 mm	150 mm	CTC-1163612	301.76
BUCKET							
	0875531		P-UB-10	110 mm	160 mm	CTC-0876654	320.96
	0875633		P-UB-10	85 mm	120 mm	CTC-0875394	258.77
	7Y5100		P-UB-10	85 mm	130 mm	CTC-7Y5145	267.26
	7Y5150		P-UB-10	105 mm	150 mm	CTC-1163612	301.76
STICK							
	7Y4926		P-UB-10	110 mm	170 mm	CTC-1163649	376.59
<b>MODEL 330B, 330BL</b>							
BOOM							
	1163578		P-UB-10	105 mm	150 mm	CTC-1680758	349.00
	1336808		P-UB-10	105 mm	150 mm	CTC-1289277	367.94
BUCKET							
	1183921		P-UB-10	105 mm	150 mm	CTC-1680758	349.00
	1183935		P-UB-10	110 mm	160 mm	CTC-1680760	388.71
	1184134		P-UB-10	85 mm	120 mm	CTC-1184131	249.86
	1336810		P-UB-10	105 mm	150 mm	CTC-1289277	367.94
	1336811		P-UB-10	110 mm	160 mm	CTC-1289280	385.33
STICK							
	0875375		P-UB-10	130 mm	180 mm	CTC-0875407	398.13
	1163638		P-UB-10	110 mm	170 mm	CTC-1680759	400.71
	1336809		P-UB-10	110 mm	170 mm	CTC-1289278	397.28
<b>MODEL 330C</b>							
BOOM							
GKX1-UP; JAB1-UP; JCD1-UP; JNK1-UP; KDD1-UP; MCA1-UP							
	1915548		P-UB-10	105 mm	150 mm	CTC-1915619	162.21
	1915548		Bushing	105 mm		CTC-1140760	54.85
GKX1-UP; JAB1-UP; KDD1-UP; MCA1-UP							
	2502473		P-UB-10	105 mm	150 mm	CTC-2502475	136.08
	2502473		Bushing	105 mm		CTC-1140760	54.85
GKX1-UP; MCA1-UP							
	2502419		P-UB-10	105 mm	150 mm	CTC-2426840	175.50
	2502419		Bushing	105 mm		CTC-1140760	54.85
JAB1-UP; KDD1-UP							
	1948270		P-UB-10	105 mm	150 mm	CTC-2003315	162.21
	1948270		Bushing	105 mm		CTC-1140760	54.85
	2502419		P-UB-10	105 mm	150 mm	CTC-2426840	175.50
	2502419		Bushing	105 mm		CTC-1140760	54.85
	2590742		P-UB-10	105 mm	150 mm	CTC-2590743	125.22
	2590742		Bushing	105 mm		CTC-1140760	54.85
JCD1-UP; JNK1-UP							
	2502419		P-UB-10	105 mm	150 mm	CTC-2426840	175.50
	2502419		Bushing	105 mm		CTC-1140760	54.85
BUCKET							
GKX1-UP; JAB1-UP; JCD1-UP; JNK1-UP; KDD1-UP; MCA1-UP							
	1772465		P-UB-10	105 mm	150 mm	CTC-1915619	162.21
	1772465		Bushing	105 mm		CTC-1140760	54.85
	1915554		P-UB-10	110 mm	160 mm	CTC-2159988	199.79
	1915554		Bushing	110 mm		CTC-1140762	81.65
	2478853		P-UB-10	105 mm	150 mm	CTC-1915619	162.21
	2478853		Bushing	105 mm		CTC-1140760	54.85
GKX1-UP; JAB1-UP; KDD1-UP; MCA1-UP							
	2478854		P-UB-10	105 mm	150 mm	CTC-2502475	136.08
	2478854		Bushing	105 mm		CTC-1140760	54.85

**CATERPILLAR®**



## REPLACEMENT KITS FOR CATERPILLAR® EQUIPMENT

Excavators							
APPLICATION	CYL #	Misc-Parts, Instructions, etc.	CODE	ROD	BORE	KIT #	List \$
<b>MODEL 330C</b>							
<b>BUCKET</b>							
JAB1-UP; KDD1-UP							
1948276		P-UB-10	105 mm	150 mm		CTC-2003315	162.21
1948276		Bushing	105 mm			CTC-1140760	54.85
1948279		P-UB-10	110 mm	160 mm		CTC-1948235	236.66
1948279		Bushing	110 mm			CTC-1140762	81.65
2590746		P-UB-10	105 mm	150 mm		CTC-2590743	125.22
2590746		Bushing	105 mm			CTC-1140760	54.85
2590750		P-UB-10	110 mm	160 mm		CTC-2590751	230.22
2590750		Bushing	110 mm			CTC-1140762	81.65
JCD1-UP							
1709808		P-UB-10	65 mm	100 mm		CTC-1709941	129.73
1709808		Bushing	65 mm			CTC-1140754	24.80
2959396		P-UB-10	65 mm	100 mm		CTC-1709941	129.73
2959396		Bushing	65 mm			CTC-1140754	24.80
JCD1-UP; JNK1-UP							
1589061		P-U-10	85 mm	120 mm		CTC-2366389	109.57
1589061		Bushing	85 mm			CTC-1140756	35.81
2836132		P-UB-10	85 mm	120 mm		CTC-2366368	109.57
2836132		Bushing	85 mm			CTC-1140756	35.81
<b>STICK</b>							
GKX1-UP; JAB1-UP; KDD1-UP; MCA1-UP							
1915551		P-UB-10	115 mm	170 mm		CTC-2316844	317.73
1948273		P-UB-10	115 mm	170 mm		CTC-2316845	324.40
2897763		P-UB-10	115 mm	170 mm		CTC-2316844	317.73
2897780		P-UB-10	115 mm	170 mm		CTC-2316845	324.40
JAB1-UP; KDD1-UP							
2590767		P-UB-10	115 mm	170 mm		CTC-2590768	323.25
2897784		P-UB-10	115 mm	170 mm		CTC-2590768	323.25
JCD1-UP; JNK1-UP							
1915551		P-UB-10	115 mm	170 mm		CTC-2316844	317.73
<b>UNSPECIFIED APPLICATION</b>							
JCD1-UP; JNK1-UP							
1234121		P-UB-10	2	4		CTC-1234121K	76.56
<b>MODEL 330C L</b>							
<b>BOOM</b>							
CAP1-UP; CGZ1-UP							
2255306		P-UB-10	110 mm	180 mm		CTC-2304001	262.70
2255306		Bushing	110 mm			CTC-1140762	81.65
CAP1-UP; CGZ1-UP; GKX1-UP; JAB1-UP; JCD1-UP; JNK1-UP; KDD1-UP; MCA1-UP; MKM1-UP							
1915548		P-UB-10	105 mm	150 mm		CTC-1915619	162.21
1915548		Bushing	105 mm			CTC-1140760	54.85
CAP1-UP; CGZ1-UP; JCD1-UP; JNK1-UP							
2502419		P-UB-10	105 mm	150 mm		CTC-2426840	175.50
2502419		Bushing	105 mm			CTC-1140760	54.85
CYA1-UP							
1915548		P-UB-10	105 mm	150 mm		CTC-1884219	162.21
1915548		Bushing	105 mm			CTC-1140760	54.85
DKY1-UP							
1915548		P-UB-10	105 mm	150 mm		CTC-1884219	162.21
1915548		Bushing	105 mm			CTC-1140760	54.85
GKX1-UP; JAB1-UP; KDD1-UP; MCA1-UP							
2502473		P-UB-10	105 mm	150 mm		CTC-2502475	136.08
2502473		Bushing	105 mm			CTC-1140760	54.85
GKX1-UP; MCA1-UP; CYA1-UP							
2502419		P-UB-10	105 mm	150 mm		CTC-2426840	175.50
2502419		Bushing	105 mm			CTC-1140760	54.85

CATERPILLAR®



## REPLACEMENT KITS FOR CATERPILLAR® EQUIPMENT

Excavators							
APPLICATION	CYL #	Misc-Parts, Instructions, etc.	CODE	ROD	BORE	KIT #	List \$
<b>MODEL 330C L</b>							
<b>BOOM</b>							
JAB1-UP; KDD1-UP							
	1948270		P-UB-10	105 mm	150 mm	CTC-2003315	162.21
	1948270		Bushing	105 mm		CTC-1140760	54.85
	2502419		P-UB-10	105 mm	150 mm	CTC-2426840	175.50
	2502419		Bushing	105 mm		CTC-1140760	54.85
	2590742		P-UB-10	105 mm	150 mm	CTC-2590743	125.22
	2590742		Bushing	105 mm		CTC-1140760	54.85
MKM1-UP							
	2162731		P-UB-10	110 mm	160 mm	CTC-2042721	232.22
	2162731		Bushing	110 mm		CTC-1140762	81.65
<b>BUCKET</b>							
CAP1-UP; CGZ1-UP; DKY1-UP; GKX1-UP; JAB1-UP; JCD1-UP; JNK1-UP; KDD1-UP; MCA1-UP; MKM1-UP							
	1772465		P-UB-10	105 mm	150 mm	CTC-1915619	162.21
	1772465		Bushing	105 mm		CTC-1140760	54.85
	1915554		P-UB-10	110 mm	160 mm	CTC-2159988	199.79
	1915554		Bushing	110 mm		CTC-1140762	81.65
CAP1-UP; CGZ1-UP; GKX1-UP; JAB1-UP; JCD1-UP; JNK1-UP; KDD1-UP; MCA1-UP; MKM1-UP							
	2478853		P-UB-10	105 mm	150 mm	CTC-1915619	162.21
	2478853		Bushing	105 mm		CTC-1140760	54.85
CYA1-UP							
	1772465		P-UB-10	105 mm	150 mm	CTC-1884219	162.21
	1772465		Bushing	105 mm		CTC-1140760	54.85
	1915554		P-UB-10	110 mm	160 mm	CTC-1948396	211.79
	1915554		Bushing	110 mm		CTC-1140762	81.65
GKX1-UP; JAB1-UP; KDD1-UP; MCA1-UP							
	2478854		P-UB-10	105 mm	150 mm	CTC-2502475	136.08
	2478854		Bushing	105 mm		CTC-1140760	54.85
JAB1-UP; KDD1-UP							
	1948276		P-UB-10	105 mm	150 mm	CTC-2003315	162.21
	1948276		Bushing	105 mm		CTC-1140760	54.85
	1948279		P-UB-10	110 mm	160 mm	CTC-1948235	236.66
	1948279		Bushing	110 mm		CTC-1140762	81.65
	2590746		P-UB-10	105 mm	150 mm	CTC-2590743	125.22
	2590746		Bushing	105 mm		CTC-1140760	54.85
	2590750		P-UB-10	110 mm	160 mm	CTC-2590751	230.22
	2590750		Bushing	110 mm		CTC-1140762	81.65
JCD1-UP							
	1709808		P-UB-10	65 mm	100 mm	CTC-1709941	129.73
	1709808		Bushing	65 mm		CTC-1140754	24.80
	2959396		P-UB-10	65 mm	100 mm	CTC-1709941	129.73
	2959396		Bushing	65 mm		CTC-1140754	24.80
JCD1-UP; JNK1-UP							
	1589061		P-U-10	85 mm	120 mm	CTC-2366389	109.57
	1589061		Bushing	85 mm		CTC-1140756	35.81
	2836132		P-UB-10	85 mm	120 mm	CTC-2366368	109.57
	2836132		Bushing	85 mm		CTC-1140756	35.81
<b>QUICK COUPLER</b>							
DKY1-UP							
	1728403		I-U-14	50 mm	100 mm	CTC-2525507	159.23
<b>STICK</b>							
CAP1-UP; CGZ1-UP; JCD1-UP; JNK1-UP; MKM1-UP							
	1915551		P-UB-10	115 mm	170 mm	CTC-2316844	317.73
CYA1-UP							
	1915551		P-UB-10	115 mm	170 mm	CTC-1915649	317.73
CYA1-UP; GKX1-UP; JAB1-UP; KDD1-UP; MCA1-UP							
	2897763		P-UB-10	115 mm	170 mm	CTC-2316844	317.73

**CATERPILLAR®**





## REPLACEMENT KITS FOR CATERPILLAR® EQUIPMENT

Excavators							
APPLICATION	CYL #	Misc-Parts, Instructions, etc.	CODE	ROD	BORE	KIT #	List \$
<b>MODEL 330C L</b>							
STICK							
DKY1-UP							
1915551			P-UB-10	115 mm	170 mm	CTC-1915551K	281.62
GKX1-UP; JAB1-UP; KDD1-UP; MCA1-UP							
1915551			P-UB-10	115 mm	170 mm	CTC-2316844	317.73
1948273			P-UB-10	115 mm	170 mm	CTC-2316845	324.40
2897780			P-UB-10	115 mm	170 mm	CTC-2316845	324.40
JAB1-UP; KDD1-UP							
2590767			P-UB-10	115 mm	170 mm	CTC-2590768	323.25
2897784			P-UB-10	115 mm	170 mm	CTC-2590768	323.25
MKM1-UP							
2141591			P-UB-10	90 mm	130 mm	CTC-2119614	157.94
2141591			Bushing	90 mm		CTC-1140758	41.30
2228776			P-UB-10	100 mm	140 mm	CTC-2159985	122.51
2228776			Bushing	100 mm		CTC-1140757	50.34
UNSPECIFIED APPLICATION							
CAP1-UP; JCD1-UP; JNK1-UP							
1234121			P-UB-10	2	4	CTC-1234121K	76.56
<b>MODEL 330C LN</b>							
BOOM							
CAP1-UP; CGZ1-UP							
1915548			P-UB-10	105 mm	150 mm	CTC-1915619	162.21
1915548			Bushing	105 mm		CTC-1140760	54.85
2255306			P-UB-10	110 mm	180 mm	CTC-2304001	262.70
2255306			Bushing	110 mm		CTC-1140762	81.65
2502419			P-UB-10	105 mm	150 mm	CTC-2426840	175.50
2502419			Bushing	105 mm		CTC-1140760	54.85
BUCKET							
CAP1-UP; CGZ1-UP							
1772465			P-UB-10	105 mm	150 mm	CTC-1915619	162.21
1772465			Bushing	105 mm		CTC-1140760	54.85
1915554			P-UB-10	110 mm	160 mm	CTC-2159988	199.79
1915554			Bushing	110 mm		CTC-1140762	81.65
2478853			P-UB-10	105 mm	150 mm	CTC-1915619	162.21
2478853			Bushing	105 mm		CTC-1140760	54.85
STICK							
CAP1-UP; CGZ1-UP							
1915551			P-UB-10	115 mm	170 mm	CTC-2316844	317.73
UNSPECIFIED APPLICATION							
CAP1-UP							
1234121			P-UB-10	2	4	CTC-1234121K	76.56
<b>MODEL 330D</b>							
BOOM							
EAH1-UP; EDX1-UP; ERN1-UP; FFK1-UP; MEY1-UP; NBD1-UP; THJ1-UP							
2344598			P-UB-10	105 mm	150 mm	CTC-2426840	175.50
2344598			Bushing	105 mm		CTC-1140760	54.85
EAH1-UP; FFK1-UP							
3119517			P-UB-10	105 mm	150 mm	CTC-2426840	175.50
3119517			Bushing	105 mm		CTC-1140760	54.85
3119524			P-UB-10	105 mm	150 mm	CTC-2502475	136.08
3119524			Bushing	105 mm		CTC-1140760	54.85
EAH1-UP; FFK1-UP; MEY1-UP; NBD1-UP							
2344608			P-UB-10	105 mm	150 mm	CTC-2502475	136.08
2344608			Bushing	105 mm		CTC-1140760	54.85

**CATERPILLAR®**



## REPLACEMENT KITS FOR CATERPILLAR® EQUIPMENT

Excavators							
APPLICATION	CYL #	Misc-Parts, Instructions, etc.	CODE	ROD	BORE	KIT #	List \$
<b>MODEL 330D</b>							
BOOM							
EDX1-UP; MEY1-UP; NBD1-UP							
2668074			P-UB-10	105 mm	150 mm	CTC-2590743	125.22
2668074			Bushing	105 mm		CTC-1140760	54.85
2898021			P-UB-10	105 mm	150 mm	CTC-2426840	175.50
2898021			Bushing	105 mm		CTC-1140760	54.85
MEY1-UP; NBD1-UP							
2898050			P-UB-10	105 mm	150 mm	CTC-2502475	136.08
2898050			Bushing	105 mm		CTC-1140760	54.85
BUCKET							
EAH1-UP; EDX1-UP; ERN1-UP; FFK1-UP; MEY1-UP; NBD1-UP; THJ1-UP							
2254581			P-UB-10	105 mm	150 mm	CTC-1915619	162.21
2254581			Bushing	105 mm		CTC-1140760	54.85
2344604			P-UB-10	110 mm	160 mm	CTC-2254625	269.79
2344604			Bushing	110 mm		CTC-1140762	81.65
EAH1-UP; FFK1-UP; MEY1-UP; NBD1-UP							
2254602			P-UB-10	105 mm	150 mm	CTC-2502475	136.08
2254602			Bushing	105 mm		CTC-1140760	54.85
2344614			P-UB-10	110 mm	160 mm	CTC-1948235	236.66
2344614			Bushing	110 mm		CTC-1140762	81.65
EDX1-UP; MEY1-UP; NBD1-UP							
2668083			P-UB-10	110 mm	160 mm	CTC-2590751	230.22
2668083			Bushing	110 mm		CTC-1140762	81.65
ERN1-UP; THJ1-UP							
2426767			P-UB-10	85 mm	120 mm	CTC-2478790	109.57
2426767			Bushing	85 mm		CTC-1140756	35.81
2898012			P-UB-10	105 mm	150 mm	CTC-1915619	162.21
2898012			Bushing	105 mm		CTC-1140760	54.85
2898041			P-UB-10	110 mm	160 mm	CTC-2254625	269.79
2898041			Bushing	110 mm		CTC-1140762	81.65
STICK							
EAH1-UP; EDX1-UP; ERN1-UP; FFK1-UP; MEY1-UP; NBD1-UP; THJ1-UP							
2344601			P-UB-10	115 mm	170 mm	CTC-2316844	317.73
2836188			P-UB-10	115 mm	170 mm	CTC-2316844	317.73
EAH1-UP; FFK1-UP; MEY1-UP; NBD1-UP							
2836194			P-UB-10	115 mm	170 mm	CTC-2316845	324.40
EDX1-UP; MEY1-UP; NBD1-UP							
2668077			P-UB-10	115 mm	170 mm	CTC-2590768	323.25
2836195			P-UB-10	115 mm	170 mm	CTC-2590768	323.25
2898031			P-UB-10	115 mm	170 mm	CTC-2316844	317.73
MEY1-UP; NBD1-UP							
2344611			P-UB-10	115 mm	170 mm	CTC-2316845	324.40
2898053			P-UB-10	115 mm	170 mm	CTC-2316845	324.40
<b>MODEL 330D L</b>							
BOOM							
B6H1-UP; EAH1-UP; EDX1-UP; FFK1-UP; GGE1-UP; HAS1-UP; JLP1-UP; MAG1-UP; MEY1-UP; MWP1-UP; NBD1-UP; RAS1-UP; T2Y1-UP							
2344598			P-UB-10	105 mm	150 mm	CTC-2426840	175.50
2344598			Bushing	105 mm		CTC-1140760	54.85
B6H1-UP; EDX1-UP; GGE1-UP; JLP1-UP; LRM1-UP; MEY1-UP; MWP1-UP; NBD1-UP; RAS1-UP; T2Y1-UP							
2898021			P-UB-10	105 mm	150 mm	CTC-2426840	175.50
2898021			Bushing	105 mm		CTC-1140760	54.85
EAH1-UP; FFK1-UP							
3119517			P-UB-10	105 mm	150 mm	CTC-2426840	175.50
3119517			Bushing	105 mm		CTC-1140760	54.85
3119524			P-UB-10	105 mm	150 mm	CTC-2502475	136.08
3119524			Bushing	105 mm		CTC-1140760	54.85

CATERPILLAR®



## REPLACEMENT KITS FOR CATERPILLAR® EQUIPMENT

Excavators							
APPLICATION	CYL #	Misc-Parts, Instructions, etc.	CODE	ROD	BORE	KIT #	List \$
<b>MODEL 330D L</b>							
<b>BOOM</b>							
EAH1-UP; FFK1-UP; MEY1-UP; NBD1-UP							
2344608			P-UB-10	105 mm	150 mm	CTC-2502475	136.08
2344608			Bushing	105 mm		CTC-1140760	54.85
EDX1-UP; MEY1-UP; NBD1-UP							
2668074			P-UB-10	105 mm	150 mm	CTC-2590743	125.22
2668074			Bushing	105 mm		CTC-1140760	54.85
GGE1-UP; RAS1-UP							
2255306			P-UB-10	110 mm	180 mm	CTC-2304001	262.70
2255306			Bushing	110 mm		CTC-1140762	81.65
MEY1-UP; NBD1-UP							
2898050			P-UB-10	105 mm	150 mm	CTC-2502475	136.08
2898050			Bushing	105 mm		CTC-1140760	54.85
<b>BUCKET</b>							
B6H1-UP; EAH1-UP; EDX1-UP; FFK1-UP; GGE1-UP; HAS1-UP; JLP1-UP; MAG1-UP; MEY1-UP; MWP1-UP; NBD1-UP; RAS1-UP; T2Y1-UP							
2254581			P-UB-10	105 mm	150 mm	CTC-1915619	162.21
2254581			Bushing	105 mm		CTC-1140760	54.85
B6H1-UP; EAH1-UP; EDX1-UP; FFK1-UP; GGE1-UP; JLP1-UP; MEY1-UP; NBD1-UP; RAS1-UP; T2Y1-UP							
2344604			P-UB-10	110 mm	160 mm	CTC-2254625	269.79
2344604			Bushing	110 mm		CTC-1140762	81.65
B6H1-UP; GGE1-UP; HAS1-UP; JLP1-UP; LRM1-UP; MWP1-UP; RAS1-UP; T2Y1-UP							
2898012			P-UB-10	105 mm	150 mm	CTC-1915619	162.21
2898012			Bushing	105 mm		CTC-1140760	54.85
EAH1-UP; FFK1-UP; MEY1-UP; NBD1-UP							
2254602			P-UB-10	105 mm	150 mm	CTC-2502475	136.08
2254602			Bushing	105 mm		CTC-1140760	54.85
2344614			P-UB-10	110 mm	160 mm	CTC-1948235	236.66
2344614			Bushing	110 mm		CTC-1140762	81.65
EDX1-UP; MEY1-UP; NBD1-UP							
2668083			P-UB-10	110 mm	160 mm	CTC-2590751	230.22
2668083			Bushing	110 mm		CTC-1140762	81.65
GGE1-UP; HAS1-UP; LRM1-UP; MWP1-UP; RAS1-UP; T2Y1-UP							
2898041			P-UB-10	110 mm	160 mm	CTC-2254625	269.79
2898041			Bushing	110 mm		CTC-1140762	81.65
MWP1-UP							
2254529			P-UB-10	110 mm	160 mm	CTC-2254625	269.79
2254529			Bushing	110 mm		CTC-1140762	81.65
<b>QUICK COUPLER</b>							
B6H1-UP; JLP1-UP							
1690753			P-U-5	40 mm	70 mm	CTC-2191322	34.53
<b>STICK</b>							
B6H1-UP; EAH1-UP; EDX1-UP; FFK1-UP; GGE1-UP; HAS1-UP; JLP1-UP; MEY1-UP; MWP1-UP; NBD1-UP; RAS1-UP; T2Y1-UP							
2344601			P-UB-10	115 mm	170 mm	CTC-2316844	317.73
B6H1-UP; EDX1-UP; GGE1-UP; MEY1-UP; NBD1-UP; RAS1-UP; T2Y1-UP; JLP1-UP; LRM1-UP							
2898031			P-UB-10	115 mm	170 mm	CTC-2316844	317.73
EAH1-UP; EDX1-UP; FFK1-UP; HAS1-UP; MAG1-UP; MEY1-UP; NBD1-UP; T2Y1-UP							
2836188			P-UB-10	115 mm	170 mm	CTC-2316844	317.73
EAH1-UP; FFK1-UP; MEY1-UP; NBD1-UP							
2836194			P-UB-10	115 mm	170 mm	CTC-2316845	324.40
EDX1-UP; MEY1-UP; NBD1-UP							
2668077			P-UB-10	115 mm	170 mm	CTC-2590768	323.25
2836195			P-UB-10	115 mm	170 mm	CTC-2590768	323.25
MEY1-UP; NBD1-UP							
2344611			P-UB-10	115 mm	170 mm	CTC-2316845	324.40
2898053			P-UB-10	115 mm	170 mm	CTC-2316845	324.40

**CATERPILLAR®**



## REPLACEMENT KITS FOR CATERPILLAR® EQUIPMENT

Excavators							
APPLICATION	CYL #	Misc-Parts, Instructions, etc.	CODE	ROD	BORE	KIT #	List \$
<b>MODEL 330D L</b>							
STICK							
MWP1-UP							
	2898031		P-UB-10	115 mm	170 mm	CTC-2316844	317.73
<b>MODEL 330D N</b>							
BOOM							
GGE1-UP; RAS1-UP							
	2255306		P-UB-10	110 mm	180 mm	CTC-2304001	262.70
	2255306		Bushing	110 mm		CTC-1140762	81.65
	2344598		P-UB-10	105 mm	150 mm	CTC-2426840	175.50
	2344598		Bushing	105 mm		CTC-1140760	54.85
	2898021		P-UB-10	105 mm	150 mm	CTC-2426840	175.50
	2898021		Bushing	105 mm		CTC-1140760	54.85
BUCKET							
GGE1-UP; RAS1-UP							
	2254581		P-UB-10	105 mm	150 mm	CTC-1915619	162.21
	2254581		Bushing	105 mm		CTC-1140760	54.85
	2344604		P-UB-10	110 mm	160 mm	CTC-2254625	269.79
	2344604		Bushing	110 mm		CTC-1140762	81.65
	2898012		P-UB-10	105 mm	150 mm	CTC-1915619	162.21
	2898012		Bushing	105 mm		CTC-1140760	54.85
	2898041		P-UB-10	110 mm	160 mm	CTC-2254625	269.79
	2898041		Bushing	110 mm		CTC-1140762	81.65
STICK							
GGE1-UP; RAS1-UP							
	2344601		P-UB-10	115 mm	170 mm	CTC-2316844	317.73
	2898031		P-UB-10	115 mm	170 mm	CTC-2316844	317.73
<b>MODEL 330L</b>							
BOOM							
	7Y4906		P-UB-10	105 mm	150 mm	CTC-1163612	301.76
BUCKET							
	1183921		P-UB-10	105 mm	150 mm	CTC-1163612	301.76
	1183935		P-UB-10	110 mm	160 mm	CTC-1183946	364.69
	411726		P-UB-10	110 mm	160 mm	CTC-0876654	320.96
	7Y5100		P-UB-10	85 mm	130 mm	CTC-7Y5145	267.26
	7Y5150		P-UB-10	105 mm	150 mm	CTC-1163612	301.76
	875531		P-UB-10	110 mm	160 mm	CTC-0876654	320.96
STICK							
	1163638		P-UB-10	110 mm	170 mm	CTC-1163649	376.59
	7Y4926		P-UB-10	110 mm	170 mm	CTC-1163649	376.59
TILT							
	1163578		P-UB-10	105 mm	150 mm	CTC-1163612	301.76
<b>MODEL 336D</b>							
BOOM							
JBT1-UP							
	3119517		P-UB-10	105 mm	150 mm	CTC-3249485	188.00
JBT1-UP; KKT1-UP; PGW1-UP							
	3119524		P-UB-10	105 mm	150 mm	CTC-2502475	136.08
KKT1-UP							
	3119531		P-UB-10	105 mm	150 mm	CTC-2502475	136.08
KKT1-UP; PGW1-UP							
	3119517		P-UB-10	105 mm	150 mm	CTC-2426840	175.50
	3119525		P-UB-10	105 mm	150 mm	CTC-2590743	125.22
	3119526		P-UB-10	105 mm	150 mm	CTC-2426840	175.50
MYP1-UP							
	2255306	Variable Adj Boom	P-UB-10	110 mm	180 mm	CTC-2304001	262.70
PGW1-UP							
	3119531		P-UB-10	105 mm	150 mm	CTC-3764334	188.00

**CATERPILLAR®**



## REPLACEMENT KITS FOR CATERPILLAR® EQUIPMENT

Excavators							
APPLICATION	CYL #	Misc-Parts, Instructions, etc.	CODE	ROD	BORE	KIT #	List \$
<b>MODEL 336D</b>							
<b>BUCKET</b>							
JBT1-UP; KKT1-UP; PGW1-UP							
3154442			P-UB-10	105 mm	150 mm	CTC-1915619	162.21
3154442			P-UB-10	105 mm	150 mm	CTC-3764331	157.38
3154449			P-UB-10	105 mm	150 mm	CTC-3764332	157.38
3154463			P-UB-10	110 mm	160 mm	CTC-2254625	269.79
3154471			P-UB-10	110 mm	160 mm	CTC-1948235	236.66
JBT1-UP; PGW1-UP							
3154463			P-UB-10	110 mm	160 mm	CTC-3338750	172.56
KKT1-UP							
2668083			P-UB-10	110 mm	160 mm	CTC-2590751	230.22
2898041			P-UB-10	110 mm	160 mm	CTC-2254625	269.79
KKT1-UP; MYG1-UP; MYP1-UP; PGW1-UP							
3154451			P-UB-10	105 mm	150 mm	CTC-1915619	162.21
KKT1-UP; PGW1-UP							
3154450			P-UB-10	105 mm	150 mm	CTC-2590743	125.22
3154455			P-UB-10	105 mm	150 mm	CTC-2502475	136.08
3154472			P-UB-10	110 mm	160 mm	CTC-2590751	230.22
3154473			P-UB-10	110 mm	160 mm	CTC-2254625	269.79
3154474			P-UB-10	110 mm	160 mm	CTC-1948235	236.66
MYG1-UP; MYP1-UP							
3154473			P-UB-10	110 mm	160 mm	CTC-3338750	172.56
<b>COUPLER</b>							
KKT1-UP; PGW1-UP							
2948011			P-U-10,12	2	3-1/2	CTC-3460643	43.93
MYG1-UP; MYP1-UP							
1690753			P-U-5	40 mm	70 mm	CTC-2191322	34.53
<b>STICK</b>							
JBT1-UP; KKT1-UP; PGW1-UP							
2836188			P-UB-10	115 mm	170 mm	CTC-2316844	317.73
2836194			P-UB-10	115 mm	170 mm	CTC-2316845	324.40
KKT1-UP							
2898031			P-UB-10	115 mm	170 mm	CTC-2316844	317.73
KKT1-UP; PGW1-UP							
2836188			P-UB-10	115 mm	170 mm	CTC-3198295	231.37
2836194			P-UB-10	115 mm	170 mm	CTC-3764333	231.37
2836195			P-UB-10	115 mm	170 mm	CTC-2590768	323.25
2898053			P-UB-10	115 mm	170 mm	CTC-2316845	324.40
MYP1-UP; PGW1-UP							
2898031			P-UB-10	115 mm	170 mm	CTC-3198295	231.37
<b>MODEL 336D L</b>							
<b>BOOM</b>							
DTS1-UP; J2F1-UP; JBF1-UP; JWR1-UP; KDJ1-UP; L5X1-UP; LMG1-UP; MDS1-UP; PPN1-UP; PRF1-UP; PTB1-UP; WET1-UP; W3K1-UP; WRKZ-UP; ZML1-UP							
3119526			P-UB-10	105 mm	150 mm	CTC-2426840	175.50
J2F1-UP; MDS1-UP; W3K1-UP; ZML1-UP							
3585972			P-UB-10	105 mm	150 mm	CTC-3249485	188.00
KDJ1-UP							
2255306	Variable Adj Boom		P-UB-10	110 mm	180 mm	CTC-2304001	262.70
M4T1-UP							
2898021			P-UB-10	105 mm	150 mm	CTC-2426840	175.50
MPL1-UP							
3119517			P-UB-10	105 mm	150 mm	CTC-3249485	188.00
MPL1-UP; PRF1-UP; WRK1-UP							
3119524			P-UB-10	105 mm	150 mm	CTC-2502475	136.08
PRF1-UP							
3119531			P-UB-10	105 mm	150 mm	CTC-2502475	136.08

**CATERPILLAR®**



## REPLACEMENT KITS FOR CATERPILLAR® EQUIPMENT

Excavators							
APPLICATION	CYL #	Misc-Parts, Instructions, etc.	CODE	ROD	BORE	KIT #	List \$
<b>MODEL 336D L</b>							
<b>BOOM</b>							
PRF1-UP; WRK1-UP							
3119517			P-UB-10	105 mm	150 mm	CTC-2426840	175.50
3119525			P-UB-10	105 mm	150 mm	CTC-2590743	125.22
WRK1-UP							
3119531			P-UB-10	105 mm	150 mm	CTC-3764334	188.00
<b>BUCKET</b>							
DTS1-UP; J2F1-UP; JBF1-UP; JWR1-UP; KDJ1-UP; LMG1-UP; MDS1-UP; PPN1-UP; PTB1-UP; WET1-UP; W3K1-UP							
3154473			P-UB-10	110 mm	160 mm	CTC-3338750	172.56
DTS1-UP; J2F1-UP; JBF1-UP; JWR1-UP; KDJ1-UP; LMG1-UP; PPN1-UP; PRF1-UP; PTB1-UP; WET1-UP; W3K1-UP; WRK1-UP; ZML1-UP							
3154451			P-UB-10	105 mm	150 mm	CTC-1915619	162.21
DTS1-UP; JBF1-UP; JWR1-UP; LMG1-UP							
2897948			P-UB-10	85 mm	120 mm	CTC-2478790	109.57
J2F1-UP; M4T1-UP							
2898012			P-UB-10	105 mm	150 mm	CTC-1915619	162.21
J2F1-UP; MDS1-UP; W3K1-UP; ZML1-UP							
3579784			P-UB-10	110 mm	160 mm	CTC-3338750	172.56
3588482			P-UB-10	110 mm	160 mm	CTC-3338750	172.56
J2F1-UP; W3K1-UP; ZML1-UP							
3579766			P-UB-10	105 mm	150 mm	CTC-3764331	157.38
M4T1-UP; PRF1-UP							
2898041			P-UB-10	110 mm	160 mm	CTC-2254625	269.79
MPL1-UP; PRF1-UP; WRK1-UP							
3154442			P-UB-10	105 mm	150 mm	CTC-1915619	162.21
3154442			P-UB-10	105 mm	150 mm	CTC-3764331	157.38
3154449			P-UB-10	105 mm	150 mm	CTC-3764332	157.38
3154463			P-UB-10	110 mm	160 mm	CTC-2254625	269.79
3154471			P-UB-10	110 mm	160 mm	CTC-1948235	236.66
MPL1-UP; WRK1-UP							
3154463			P-UB-10	110 mm	160 mm	CTC-3338750	172.56
PRF1-UP							
2668083			P-UB-10	110 mm	160 mm	CTC-2590751	230.22
PRF1-UP; WRK1-UP							
3154450			P-UB-10	105 mm	150 mm	CTC-2590743	125.22
3154455			P-UB-10	105 mm	150 mm	CTC-2502475	136.08
3154472			P-UB-10	110 mm	160 mm	CTC-2590751	230.22
3154473			P-UB-10	110 mm	160 mm	CTC-2254625	269.79
3154474			P-UB-10	110 mm	160 mm	CTC-1948235	236.66
<b>COUPLER</b>							
DTS1-UP; JBF1-UP; KDJ1-UP; LMG1-UP; M4T1-UP; PPN1-UP; WET1-UP							
1690753			P-U-5	40 mm	70 mm	CTC-2191322	34.53
J2F1-UP; W3K1-UP							
3270338			I-U-10	75 mm	100 mm	CTC-3265051	66.61
PRF1-UP; W3K1-UP; WRK1-UP							
2948011			P-U-10,12	2	3-1/2	CTC-3460643	43.93
<b>STICK</b>							
DTS1-UP; JBF1-UP; JWR1-UP; KDJ1-UP; LMG1-UP; PPN1-UP; PTB1-UP; WET1-UP; WRK1-UP							
2898031			P-UB-10	115 mm	170 mm	CTC-3198295	231.37
J2F1-UP; M4T1-UP; MDS1-UP; PRF1-UP; W3K1-UP; ZML1-UP							
2898031			P-UB-10	115 mm	170 mm	CTC-2316844	317.73
J2F1-UP; MDS1-UP; W3K1-UP; ZML1-UP							
3751722			P-UB-10	115 mm	170 mm	CTC-3751733	252.09
MPL1-UP; PRF1-UP; WRK1-UP							
2836188			P-UB-10	115 mm	170 mm	CTC-2316844	317.73
2836194			P-UB-10	115 mm	170 mm	CTC-2316845	324.40

CATERPILLAR®



## REPLACEMENT KITS FOR CATERPILLAR® EQUIPMENT

<b>Excavators</b>							
APPLICATION	CYL #	Misc-Parts, Instructions, etc.	CODE	ROD	BORE	KIT #	List \$
<b>MODEL 336D L</b>							
STICK							
PRF1-UP; WRK1-UP							
	2836188		P-UB-10	115 mm	170 mm	CTC-3198295	231.37
	2836194		P-UB-10	115 mm	170 mm	CTC-3764333	231.37
	2836195		P-UB-10	115 mm	170 mm	CTC-2590768	323.25
	2898053		P-UB-10	115 mm	170 mm	CTC-2316845	324.40
<b>MODEL 336D LN</b>							
BOOM							
MYG1-UP; MYP1-UP							
	3119526		P-UB-10	105 mm	150 mm	CTC-2426840	175.50
STICK							
MYG1-UP							
	2898031		P-UB-10	115 mm	170 mm	CTC-3198295	231.37
<b>MODEL 345B, 345BL</b>							
BOOM							
	1297829		P-UB-10	110 mm	160 mm	CTC-1680760	388.71
	1553737		P-UB-10	110 mm	160 mm	CTC-1680760	388.71
BUCKET							
	1183935		P-UB-10	110 mm	160 mm	CTC-1680760	388.71
	1184134		P-UB-10	85 mm	120 mm	CTC-1184131	249.86
	1232044		P-UB-10	90 mm	130 mm	CTC-1184175	295.27
	1297835		P-UB-10	110 mm	170 mm	CTC-1680759	400.71
COUNTERWEIGHT							
	1231078		P-UB-10	3	4-3/4	CTC-1570288	172.37
MATERIAL HANDLER							
	1504125		P-UB-10	110 mm	170 mm	CTC-1680759	400.71
STEERING							
	1151371		P-UB-10	2-1/4	4	CTC-1546526	150.74
STICK							
	1163638		P-UB-10	110 mm	170 mm	CTC-1680759	400.71
	1297832		P-UB-10	130 mm	190 mm	CTC-1261979	294.32
<b>MODEL 345C</b>							
BOOM							
BWY1-UP; ELS1-UP; GCL1-UP; TAJ1-UP; TBA1-UP; WDE1-UP							
	2254523		P-UB-10	110 mm	160 mm	CTC-2254625	269.79
	2254523		Bushing	110 mm		CTC-1140762	81.65
BWY1-UP; TBA1-UP; WDE1-UP							
	2668087		P-UB-10	110 mm	160 mm	CTC-2742460	264.49
	2668087		Bushing	110 mm		CTC-1140762	81.65
BUCKET							
BWY1-UP; ELS1-UP; GCL1-UP; TAJ1-UP; TBA1-UP; WDE1-UP							
	2254529		P-UB-10	110 mm	160 mm	CTC-2254625	269.79
	2254529		Bushing	110 mm		CTC-1140762	81.65
	2254532		P-UB-10	110 mm	170 mm	CTC-2344442	238.85
	2254532		Bushing	110 mm		CTC-1140761	87.22
BWY1-UP; TBA1-UP; WDE1-UP							
	2742456		P-UB-10	110 mm	160 mm	CTC-2742460	264.49
	2742456		Bushing	110 mm		CTC-1140762	81.65
	2742459		P-UB-10	110 mm	170 mm	CTC-2742462	269.29
	2742459		Bushing	110 mm		CTC-1140761	87.22
COUNTERWEIGHT							
BWY1-UP; TAJ1-UP; TBA1-UP; WDE1-UP							
	2369769		P-UB-10	3	4-3/4	CTC-2369769K	100.39
STICK							
BWY1-UP; ELS1-UP; GCL1-UP; TAJ1-UP; TBA1-UP; WDE1-UP							
	2254526		P-UB-10	130 mm	190 mm	CTC-2254646	321.61
	2254526		Bushing	130 mm		CTC-1140763	83.31

**CATERPILLAR®**





## REPLACEMENT KITS FOR CATERPILLAR® EQUIPMENT

Excavators							
APPLICATION	CYL #	Misc-Parts, Instructions, etc.	CODE	ROD	BORE	KIT #	List \$
<b>MODEL 345C</b>							
STICK							
BWY1-UP; TAJ1-UP; TBA1-UP; WDE1-UP							
2426839			P-UB-10	130 mm	190 mm	CTC-2254646	321.61
2426839			Bushing	130 mm		CTC-1140763	83.31
BWY1-UP; TBA1-UP; WDE1-UP							
2742453			P-UB-10	130 mm	190 mm	CTC-2742461	435.75
2742453			Bushing	130 mm		CTC-1140763	83.31
<b>MODEL 345C L</b>							
BOOM							
BWY1-UP; DHP1-UP; ELS1-UP; ESD1-UP; FPC1-UP; GCL1-UP; GJR1-UP; GPH1-UP; LYS1-UP; PJW1-UP; S5M1-UP; TBA1-UP; TDG1-UP; WDE1-UP							
2254523			P-UB-10	110 mm	160 mm	CTC-2254625	269.79
2254523			Bushing	110 mm		CTC-1140762	81.65
BWY1-UP; DHP1-UP; GJR1-UP; TBA1-UP; WDE1-UP							
2668087			P-UB-10	110 mm	160 mm	CTC-2742460	264.49
2668087			Bushing	110 mm		CTC-1140762	81.65
BUCKET							
BWY1-UP; DHP1-UP; ELS1-UP; ESD1-UP; FPC1-UP; GCL1-UP; GJR1-UP; GPH1-UP; LYS1-UP; PJW1-UP; PJW1-UP; S5M1-UP; TBA1-UP; TDG1-UP; TDG1-UP; WDE1-UP							
2254529			P-UB-10	110 mm	160 mm	CTC-2254625	269.79
2254529			Bushing	110 mm		CTC-1140762	81.65
BWY1-UP; DHP1-UP; ELS1-UP; ESD1-UP; GCL1-UP; GJR1-UP; GPH1-UP; LYS1-UP; PJW1-UP; S5M1-UP; TBA1-UP; TDG1-UP; WDE1-UP							
2254532			P-UB-10	110 mm	170 mm	CTC-2344442	238.85
2254532			Bushing	110 mm		CTC-1140761	87.22
BWY1-UP; DHP1-UP; GJR1-UP; TBA1-UP; WDE1-UP							
2742456			P-UB-10	110 mm	160 mm	CTC-2742460	264.49
2742456			Bushing	110 mm		CTC-1140762	81.65
2742459			P-UB-10	110 mm	170 mm	CTC-2742462	269.29
2742459			Bushing	110 mm		CTC-1140761	87.22
COUNTERWEIGHT							
BWY1-UP; DHP1-UP; ESD1-UP; FPC1-UP; GJR1-UP; PJW1-UP; TBA1-UP; TDG1-UP; WDE1-UP							
2369769			P-UB-10	3	4-3/4	CTC-2369769K	100.39
STICK							
BWY1-UP; DHP1-UP; ELS1-UP; ESD1-UP; FPC1-UP; GCL1-UP; GJR1-UP; GPH1-UP; LYS1-UP; PJW1-UP; S5M1-UP; TBA1-UP; TDG1-UP; WDE1-UP							
2254526			P-UB-10	130 mm	190 mm	CTC-2254646	321.61
2254526			Bushing	130 mm		CTC-1140763	83.31
BWY1-UP; DHP1-UP; ESD1-UP; GJR1-UP; PJW1-UP; S5M1-UP; TBA1-UP; TDG1-UP; WDE1-UP							
2426839			P-UB-10	130 mm	190 mm	CTC-2254646	321.61
2426839			Bushing	130 mm		CTC-1140763	83.31
BWY1-UP; DHP1-UP; GJR1-UP; TBA1-UP; WDE1-UP							
2742453			P-UB-10	130 mm	190 mm	CTC-2742461	435.75
2742453			Bushing	130 mm		CTC-1140763	83.31
<b>MODEL 345D L</b>							
BOOM							
BYC1-UP; EEH1-UP; GYR1-UP; JKN1-UP; KFH1-UP; LKY1-UP; MLK1-UP; NLM1-UP; PBT1-UP; RAE1-UP; RAJ1-UP; RGD1-UP; RGG1-UP; YEE1-UP							
2254523			P-UB-10	110 mm	160 mm	CTC-3764336	180.37
BYC1-UP; JKN1-UP; PBT1-UP; RAE1-UP							
2668087			P-UB-10	110 mm	160 mm	CTC-2742460	264.49
BUCKET							
BYC1-UP; EEH1-UP; GYR1-UP; JKN1-UP; KFH1-UP; LKY1-UP; MLK1-UP; NLM1-UP; RAE1-UP; PBT1-UP; RAJ1-UP; RGD1-UP; RGG1-UP; YEE1-UP							
2254532			P-UB-10	110 mm	170 mm	CTC-3338675	222.64
BYC1-UP; EEH1-UP; GYR1-UP; JKN1-UP; KFH1-UP; LKY1-UP; NLM1-UP; MLK1-UP; PBT1-UP; RAE1-UP; RAJ1-UP; RGG1-UP; YEE1-UP							
2937678			P-UB-10	110 mm	160 mm	CTC-2254625	269.79

**CATERPILLAR®**



## REPLACEMENT KITS FOR CATERPILLAR® EQUIPMENT

Excavators							
APPLICATION	CYL #	Misc-Parts, Instructions, etc.	CODE	ROD	BORE	KIT #	List \$
<b>MODEL 345D L</b>							
BUCKET							
BYC1-UP; GYR1-UP; KFH1-UP; LKY1-UP; NLM1-UP; RGD1-UP; RGG1-UP							
2254529			P-UB-10	110 mm	160 mm	CTC-3338750	172.56
BYC1-UP; JKN1-UP; PBT1-UP; RAE1-UP							
2742456			P-UB-10	110 mm	160 mm	CTC-2742460	264.49
2742459			P-UB-10	110 mm	170 mm	CTC-2742462	269.29
EEH1-UP; JKN1-UP; MLK1-UP; PBT1-UP; RAE1-UP; RAJ1-UP; YEE1-UP							
2254529			P-UB-10	110 mm	160 mm	CTC-2254625	269.79
EEH1-UP; RAJ1-UP; YEE1-UP							
3675217			P-UB-10	110 mm	160 mm	CTC-3338750	172.56
COUNTERWEIGHT							
BYC1-UP; EEH1-UP; JKN1-UP; PBT1-UP; RAE1-UP; RAJ1-UP; YEE1-UP							
2369769			P-UB-10	3	4-3/4	CTC-2369769K	100.39
COUPLER							
EEH1-UP; JKN1-UP; RAJ1-UP; YEE1-UP							
3030703	Quick Coupler		P-U-10,12	3-1/4	5-1/2	CTC-3460644	97.87
EEH1-UP; MLK1-UP; RAJ1-UP; YEE1-UP							
1690753	Lock		P-U-5	40 mm	70 mm	CTC-2191322	34.53
EEH1-UP; RAJ1-UP; YEE1-UP							
2692106			I-U-14	50 mm	100 mm	CTC-2525507	159.23
3242645			I-U-10	50 mm	100 mm	CTC-3265946	69.64
STICK							
BYC1-UP; GYR1-UP; JKN1-UP; KFH1-UP; LKY1-UP; MLK1-UP; NLM1-UP; PBT1-UP; RAE1-UP; RGD1-UP; RGG1-UP; YEE1-UP							
2254526			P-UB-10	130 mm	190 mm	CTC-3319328	330.30
BYC1-UP; JKN1-UP; PBT1-UP; RAE1-UP							
2742453			P-UB-10	130 mm	190 mm	CTC-2742461	435.75
EEH1-UP; RAJ1-UP							
2254526			P-UB-10	130 mm	190 mm	CTC-2254646	321.61
<b>MODEL 350, 350L</b>							
BOOM							
411515			P-UB-10	110 mm	170 mm	CTC-1163649	376.59
411515			P-UB-10	110 mm	170 mm	CTC-1680759	400.71
BUCKET							
411726			P-UB-10	110 mm	160 mm	CTC-0876654	320.96
413792			P-UB-10	130 mm	180 mm	CTC-0875407	398.13
7Y5100			P-UB-10	85 mm	130 mm	CTC-7Y5145	267.26
LIFT							
6E3529			P-UB-10	2-1/2	4	CTC-7I0968	144.59
STICK							
0875375			P-UB-10	130 mm	180 mm	CTC-0875407	398.13
<b>MODEL 365, 365B</b>							
COUNTERWEIGHT							
1505913			P-UB-10	90 mm	130 mm	CTC-1184175	295.27
<b>MODEL 375</b>							
BOOM							
1140596			P-UB-10	140 mm	200 mm	CTC-1560626	652.90
6E0018			P-UB-10	140 mm	200 mm	CTC-1560626	652.90
BUCKET							
6E0020			P-UB-10	150 mm	220 mm	CTC-1560627	583.39
6E0021			P-UB-10	140 mm	200 mm	CTC-1560626	652.90
LIFT							
6E3529			P-UB-10	2-1/2	4	CTC-7I0968	144.59
STICK							
1560664			P-UB-10	150 mm	220 mm	CTC-1560627	583.39
6E0019			P-UB-10	150 mm	220 mm	CTC-1560627	583.39

CATERPILLAR®



## REPLACEMENT KITS FOR CATERPILLAR® EQUIPMENT

Excavators							
APPLICATION	CYL #	Misc-Parts, Instructions, etc.	CODE	ROD	BORE	KIT #	List \$
<b>MODEL 375L</b>							
BOOM							
	6E0018		P-UB-10	140 mm	200 mm	CTC-1560626	652.90
BUCKET							
	411726		P-UB-10	110 mm	160 mm	CTC-0876654	320.96
LIFT							
	6E3529		P-UB-10	2-1/2	4	CTC-710968	144.59
STICK							
	6E0019		P-UB-10	150 mm	220 mm	CTC-518893	799.01
<b>MODEL E70B</b>							
BLADE							
	5TG1-UP; 6AK1-UP						
	0856321		P-UB-15	50 mm	90 mm	CTC-0933045	327.93
	0856322		P-UB-15	50 mm	90 mm	CTC-0933045	327.93
BOOM							
	5TG1-UP; 6AK1-UP						
	0855096		P-UB-14	75 mm	110 mm	CTC-0995310	271.87
	0856331		P-UB-14	60 mm	90 mm	CTC-0996978	125.61
	0996923		P-UB-14	75 mm	110 mm	CTC-0995310	271.87
	419618		P-UB-14	75 mm	110 mm	CTC-0995310	271.87
	516871		P-UB-14	75 mm	110 mm	CTC-0995310	271.87
BUCKET							
	5TG1-UP; 6AK1-UP						
	0997005		P-UB-14	55 mm	80 mm	CTC-0997004	124.45
STICK							
	5TG1-UP; 6AK1-UP						
	0856337		P-UB-14	60 mm	90 mm	CTC-0996978	125.61
	0996979		P-UB-14	60 mm	90 mm	CTC-0996978	125.61
	1R9847		P-UB-14	60 mm	90 mm	CTC-0996978	125.61
<b>MODEL E110</b>							
BOOM							
	0936151		P-UB-15	70 mm	110 mm	CTC-0938385	228.74
BUCKET							
	0936181		P-UB-15	65 mm	110 mm	CTC-0938390	338.42
STICK							
	0936167		P-UB-15	80 mm	120 mm	CTC-0938388	381.60
<b>MODEL E110B</b>							
BOOM							
	0995402		P-UB-14	70 mm	100 mm	CTC-0995401	232.17
	0995403		P-UB-14	70 mm	100 mm	CTC-0995401	232.17
STICK							
	0855801		P-UB-14	75 mm	110 mm	CTC-0995310	271.87
	0856657		P-UB-14	75 mm	100 mm	CTC-0860174	270.29
	0861937		P-UB-14	75 mm	110 mm	CTC-0995310	271.87
	0995369		P-UB-14	75 mm	110 mm	CTC-0995310	271.87
<b>MODEL E120</b>							
BOOM LH							
	0958487		P-UB-10	75 mm	110 mm	CTC-0967786	353.15
BOOM RH							
	0958486		P-UB-10	75 mm	110 mm	CTC-0967786	353.15
BUCKET							
	0938997		P-UB-10	65 mm	100 mm	CTC-0967625	337.15
STICK							
	0938966		P-UB-10	80 mm	120 mm	CTC-0967799	340.35
<b>MODEL E120B</b>							
BOOM LH							
	0990662		P-UB-14	75 mm	110 mm	CTC-0995310	271.87



## REPLACEMENT KITS FOR CATERPILLAR® EQUIPMENT

<b>Excavators</b>							
APPLICATION	CYL #	Misc-Parts, Instructions, etc.	CODE	ROD	BORE	KIT #	List \$
<b>MODEL E120B</b>							
BOOM RH	0990663		P-UB-14	75 mm	110 mm	CTC-0995310	271.87
BUCKET	0990701		P-UB-14	65 mm	100 mm	CTC-0995312	294.68
STICK	7NF01890-03529						
	0861868		P-UB-14	80 mm	120 mm	CTC-0995311	290.14
	7NF03530-UP						
	0855740		P-UB-14	80 mm	120 mm	CTC-0995311	290.14
	7NF1-01889						
	0990682		P-UB-14	80 mm	120 mm	CTC-0995311	290.14
TELESCOPIC STICK	0856657		P-UB-14	75 mm	100 mm	CTC-0860174	270.29
<b>MODEL E180, EL180</b>							
BOOM LH	0941911		P-UB-10	85 mm	125 mm	CTC-0940691	322.75
BOOM RH	0941926		P-UB-10	85 mm	125 mm	CTC-0940691	322.75
BUCKET	0941946		P-UB-10	85 mm	125 mm	CTC-0940691	322.75
STICK	0941929		P-UB-10	100 mm	140 mm	CTC-0941910	385.24
<b>MODEL E200B, EL200B</b>							
BOOM LH	0967907		P-UB-10	85 mm	120 mm	CTC-0964395	388.95
BOOM RH	0967908		P-UB-10	85 mm	120 mm	CTC-0964395	388.95
BUCKET	0967909		P-UB-10	75 mm	115 mm	CTC-0966457	360.69
BUCKET LONG REACH	0993713		P-UB-14	65 mm	100 mm	CTC-0995312	294.68
STICK	0967910		P-UB-10	100 mm	140 mm	CTC-1890282	290.08
STICK LONG REACH	0993688		P-UB-10	95 mm	130 mm	CTC-0964396	429.12
<b>MODEL E240, EL240</b>							
BOOM LH	0941549		P-UB-14	90 mm	140 mm	CTC-0939941	306.12
BOOM RH	0941550		P-UB-14	90 mm	140 mm	CTC-0939941	306.12
BUCKET	0962391		P-UB-14	90 mm	140 mm	CTC-0939941	306.12
STICK	0941406		P-UB-14	100 mm	150 mm	CTC-0942697	256.02
<b>MODEL E240B, EL240B</b>							
BOOM	1R8082		P-UB-14	90 mm	140 mm	CTC-0939941	306.12
BOOM LH	0996240		P-UB-14	90 mm	140 mm	CTC-0939941	306.12
BOOM RH	0996241		P-UB-14	90 mm	140 mm	CTC-0939941	306.12
BUCKET	0996233		P-UB-14	90 mm	140 mm	CTC-0939941	306.12
	1R5580		P-UB-14	65 mm	100 mm	CTC-0995312	294.68
STICK	0996237		P-UB-14	100 mm	150 mm	CTC-0942697	256.02

**CATERPILLAR®**



## REPLACEMENT KITS FOR CATERPILLAR® EQUIPMENT

Excavators							
APPLICATION	CYL #	Misc-Parts, Instructions, etc.	CODE	ROD	BORE	KIT #	List \$
<b>MODEL E300, EL300</b>							
BOOM LH							
	0946493		P-UB-14	100 mm	150 mm	CTC-0942697	256.02
BOOM RH							
	0946494		P-UB-14	100 mm	150 mm	CTC-0942697	256.02
BUCKET							
	0962932		P-UB-14	100 mm	150 mm	CTC-0942697	256.02
STICK							
	0962920		P-UB-14	110 mm	160 mm	CTC-0942698	389.76
<b>MODEL E300B, EL300B</b>							
BOOM							
	1R7823		P-UB-10	100 mm	140 mm	CTC-1890282	290.08
BOOM LH							
	0995577		P-UB-10	100 mm	140 mm	CTC-1890282	290.08
BOOM RH							
	0995578		P-UB-10	100 mm	140 mm	CTC-1890282	290.08
Excavators - Front-Shovel							
APPLICATION	CYL #	Misc-Parts, Instructions, etc.	CODE	ROD	BORE	KIT #	List \$
<b>MODEL 5080</b>							
BOOM							
	4I3915		P-UB-10	130 mm	180 mm	CTC-0875407	398.13
STICK							
	6E4272		P-UB-10	150 mm	220 mm	CTC-1560627	583.39
<b>MODEL 5110</b>							
BUCKET							
	6E0020		P-UB-10	150 mm	220 mm	CTC-1560627	583.39
<b>MODEL 5230, 5230B</b>							
BUCKET							
	6E6435		P-UB-10	3-1/2	7-1/4	CTC-1309483	330.34
Excavators - Wheel							
APPLICATION	CYL #	Misc-Parts, Instructions, etc.	CODE	ROD	BORE	KIT #	List \$
<b>MODEL M315</b>							
BOOM							
	1134979		P-UB-10	80 mm	110 mm	CTC-1247009	222.15
	1134989		P-UB-10	80 mm	110 mm	CTC-1247009	222.15
STICK							
	1141872		P-UB-10	80 mm	110 mm	CTC-1247009	222.15
	1586388		P-UB-10	75 mm	110 mm	CTC-1586389	209.70
<b>MODEL M316</b>							
BLADE							
			I-U-10	60 mm	100 mm	CTC-1183135	93.83
BOOM							
			I-U-15	60 mm	110 mm	CTC-1558421	73.41
			P-UB-10	75 mm	140 mm	CTC-2605319	406.05
COUPLER							
			I-U-5	40 mm	60 mm	CTC-2027897	41.35
STABILIZER							
			P-U-10	70 mm	130 mm	CTC-2000920	149.74
STICK							
			P-UB-10	80 mm	120 mm	CTC-2605316	115.42
<b>MODEL M318</b>							
BOOM							
	1112034		I-U-10	60 mm	100 mm	CTC-1183135	93.83
	1124231		P-UB-10	85 mm	120 mm	CTC-1247008	157.23
	1124241		P-UB-10	85 mm	120 mm	CTC-1247008	157.23
	1124243		P-UB-10	85 mm	160 mm	CTC-1247005	201.82
BUCKET							
	1124245		P-UB-10	80 mm	110 mm	CTC-1247007	260.70

**CATERPILLAR®**



## REPLACEMENT KITS FOR CATERPILLAR® EQUIPMENT

<b>Excavators - Wheel</b>							
APPLICATION	CYL #	Misc-Parts, Instructions, etc.	CODE	ROD	BORE	KIT #	List \$
<b>MODEL M318</b>							
<b>MATERIAL HANDLER</b>							
	1415981		P-UB-10	80 mm	110 mm	CTC-1247009	222.15
<b>STICK</b>							
	1124236		P-UB-10	85 mm	120 mm	CTC-1247008	157.23
<b>MODEL M320</b>							
<b>BOOM</b>							
	1279243		P-UB-10	100 mm	170 mm	CTC-1296156	192.88
	1283203		P-UB-10	95 mm	130 mm	CTC-7Y5147	298.89
<b>BUCKET</b>							
	0875633		P-UB-10	85 mm	120 mm	CTC-0875394	258.77
	0875633		P-UB-10	85 mm	120 mm	CTC-1184131	249.86
<b>STICK</b>							
	1279242		P-UB-10	100 mm	140 mm	CTC-0875387	341.66
	1386696		P-UB-10	85 mm	120 mm	CTC-1184131	249.86
<b>Forestry - Tree Harvesters</b>							
APPLICATION	CYL #	Misc-Parts, Instructions, etc.	CODE	ROD	BORE	KIT #	List \$
<b>MODEL 518</b>							
<b>TILT LH</b>							
	9T1777		P-UB-10	2-1/4	4-1/4	CTC-7X2750	114.40
<b>TILT RH</b>							
	9T1772		P-UB-10	2-1/4	4-1/4	CTC-7X2750	114.40
<b>Integrated Toolcarriers</b>							
APPLICATION	CYL #	Misc-Parts, Instructions, etc.	CODE	ROD	BORE	KIT #	List \$
<b>MODEL IT12</b>							
<b>LIFT</b>							
	4T8579		I-U-3	3/4	1-1/4	CTC-1791715	15.10
	4T8580		P-UB-10	2	3-3/4	CTC-7X2787	103.33
<b>M.P. BUCKET</b>							
	8J5391		P-UB-10	1-1/2	3-1/2	CTC-7X2752	95.40
<b>STEERING</b>							
	1U4666		P-UB-10	1-1/2	2-3/4	CTC-7X2736	126.39
	9T5153		P-UB-10	1-1/2	2-3/4	CTC-7X2736	126.39
	9T5729		I-O-3	3/4	1-1/4	CTC-1791749	5.39
<b>TILT</b>							
	4T8581		P-UB-10	1-3/4	3-1/4	CTC-7X2764	68.76
	9T5151		P-UB-10	2	3-1/2	CTC-7X2783	102.97
	9T5489		P-UB-10	1-3/4	3-1/4	CTC-7X2764	68.76
<b>MODEL IT12B</b>							
<b>LIFT</b>							
	6E6398		P-UB-10	2-1/4	3-1/2	CTC-1859503	137.55
	9T5152		P-UB-10	2-1/4	4	CTC-1859527	114.63
<b>PIN PULLER</b>							
	9T5729		I-O-3	3/4	1-1/4	CTC-1791749	5.39
<b>STEERING</b>							
	4T8579		I-U-3	3/4	1-1/4	CTC-1791715	15.10
	9T5729		I-O-3	3/4	1-1/4	CTC-1791749	5.39
	9T7209	Head# 6E4940	P-UB-10	1-1/2	2-3/4	CTC-1361599	106.50
	9T7209	Head# 9T2542	P-UB-10	1-1/2	2-3/4	CTC-7X2736	126.39
	9T7210	Head# 6E4940	P-UB-10	1-1/2	2-3/4	CTC-1361599	106.50
	9T7210	Head# 9T2542	P-UB-10	1-1/2	2-3/4	CTC-7X2736	126.39
<b>STEERING LH</b>							
	6E5900	Head# 1515349	P-UB-10	1-3/4	2-3/4	CTC-1539053	150.78
	6E5900	Head# 6E4941	P-UB-10	1-3/4	2-3/4	CTC-1857024	55.04
	6E5973		P-UB-10	1-1/2	2-3/4	CTC-1361599	106.50
	9T7209	Head# 6E4940	P-UB-10	1-1/2	2-3/4	CTC-1361599	106.50
	9T7209	Head# 9T2542	P-UB-10	1-1/2	2-3/4	CTC-7X2736	126.39

**CATERPILLAR®**



## REPLACEMENT KITS FOR CATERPILLAR® EQUIPMENT

Integrated Toolcarriers							
APPLICATION	CYL #	Misc-Parts, Instructions, etc.	CODE	ROD	BORE	KIT #	List \$
<b>MODEL IT12B</b>							
STEERING RH							
	6E5972	Head# 1515349	P-UB-10	1-3/4	2-3/4	CTC-1539053	150.78
	6E5972	Head# 6E4941	P-UB-10	1-3/4	2-3/4	CTC-1857024	55.04
	6E5985		P-UB-10	1-1/2	2-3/4	CTC-1361599	106.50
TILT							
	9T5151		P-UB-10	2	3-1/2	CTC-1857674	115.51
<b>MODEL IT12F</b>							
LIFT							
	6E6398		P-UB-10	2-1/4	3-1/2	CTC-1859503	137.55
	9T5152		P-UB-10	2-1/4	4	CTC-1859527	114.63
STEERING							
	4T8579		I-U-3	3/4	1-1/4	CTC-1791715	15.10
	9T5729		I-O-3	3/4	1-1/4	CTC-1791749	5.39
	9T7209	Head# 6E4940	P-UB-10	1-1/2	2-3/4	CTC-1361599	106.50
	9T7209	Head# 9T2542	P-UB-10	1-1/2	2-3/4	CTC-7X2736	126.39
	9T7210	Head# 6E4940	P-UB-10	1-1/2	2-3/4	CTC-1361599	106.50
	9T7210	Head# 9T2542	P-UB-10	1-1/2	2-3/4	CTC-7X2736	126.39
STEERING LH							
	6E5900	Head# 1515349	P-UB-10	1-3/4	2-3/4	CTC-1539053	150.78
	6E5900	Head# 6E4941	P-UB-10	1-3/4	2-3/4	CTC-1857024	55.04
	6E5973		P-UB-10	1-1/2	2-3/4	CTC-1361599	106.50
STEERING RH							
	6E5972	Head# 1515349	P-UB-10	1-3/4	2-3/4	CTC-1539053	150.78
	6E5972	Head# 6E4941	P-UB-10	1-3/4	2-3/4	CTC-1857024	55.04
	6E5985		P-UB-10	1-1/2	2-3/4	CTC-1361599	106.50
TILT							
	9T5151		P-UB-10	2	3-1/2	CTC-1857674	115.51
<b>MODEL IT14B</b>							
LIFT							
	9T5152		P-UB-10	2-1/4	4	CTC-1859527	114.63
PIN PULLER							
	9T5729		I-O-3	3/4	1-1/4	CTC-1791749	5.39
STEERING							
	4T8579		I-U-3	3/4	1-1/4	CTC-1791715	15.10
	9T5729		I-O-3	3/4	1-1/4	CTC-1791749	5.39
	9T7209	Head# 6E4940	P-UB-10	1-1/2	2-3/4	CTC-1361599	106.50
	9T7209	Head# 9T2542	P-UB-10	1-1/2	2-3/4	CTC-7X2736	126.39
	9T7210	Head# 6E4940	P-UB-10	1-1/2	2-3/4	CTC-1361599	106.50
	9T7210	Head# 9T2542	P-UB-10	1-1/2	2-3/4	CTC-7X2736	126.39
STEERING LH							
	6E5973		P-UB-10	1-1/2	2-3/4	CTC-1361599	106.50
	9T7209	Head# 6E4940	P-UB-10	1-1/2	2-3/4	CTC-1361599	106.50
	9T7209	Head# 9T2542	P-UB-10	1-1/2	2-3/4	CTC-7X2736	126.39
STEERING RH							
	6E5985		P-UB-10	1-1/2	2-3/4	CTC-1361599	106.50
TILT							
	9T5151		P-UB-10	2	3-1/2	CTC-1857674	115.51
<b>MODEL IT14C</b>							
TILT							
	9T5151		P-UB-10	2	3-1/2	CTC-7X2783	102.97
<b>MODEL IT14F</b>							
LIFT							
	6E6398		P-UB-10	2-1/4	3-1/2	CTC-1859503	137.55
STEERING							
	4T8579		I-U-3	3/4	1-1/4	CTC-1791715	15.10
	9T5729		I-O-3	3/4	1-1/4	CTC-1791749	5.39

CATERPILLAR®





## REPLACEMENT KITS FOR CATERPILLAR® EQUIPMENT

Integrated Toolcarriers							
APPLICATION	CYL #	Misc-Parts, Instructions, etc.	CODE	ROD	BORE	KIT #	List \$
<b>MODEL IT14F</b>							
STEERING LH							
	6E5900	Head# 1515349	P-UB-10	1-3/4	2-3/4	CTC-1539053	150.78
	6E5900	Head# 6E4941	P-UB-10	1-3/4	2-3/4	CTC-1857024	55.04
STEERING RH							
	6E5972	Head# 1515349	P-UB-10	1-3/4	2-3/4	CTC-1539053	150.78
	6E5972	Head# 6E4941	P-UB-10	1-3/4	2-3/4	CTC-1857024	55.04
<b>MODEL IT14G</b>							
FK							
	1491381		P-UB-10	2	3-1/2	CTC-1857674	115.51
LIFT							
	1116244		P-UB-10	2-1/4	3-1/2	CTC-1859503	137.55
	1314401		P-UB-10	2-1/4	3-1/2	CTC-1859503	137.55
	1314402		P-UB-10	2-1/4	3-1/2	CTC-1859503	137.55
STEERING							
	1044187		P-UB-10	1-1/2	2-1/2	CTC-1856601	51.77
	4T8579		I-U-3	3/4	1-1/4	CTC-1791715	15.10
	9T8823		I-O-3	1	2	CTC-9T0418	82.99
<b>MODEL IT18</b>							
LIFT							
	4T5544		I-O-3	1	2	CTC-9T0418	82.99
	4T8648	Head# 3G2956	P-UB-10	2-1/4	4-1/4	CTC-1859507	111.10
	4T8648	Head# 9T7349	P-UB-10	2-1/4	4-1/4	CTC-1859517	133.49
M.P. BUCKET TILT							
	4T4666		P-UB-10	2-1/2	4	CTC-1864338	81.62
PIN COUPLER							
	9T2352		I-O-3	1	2	CTC-9T0418	82.99
PIN PULLER							
	6E5392		I-O-3	1	2	CTC-9T0418	82.99
	6E5393		I-O-3	1	2	CTC-9T0418	82.99
SPECIAL APPLICATION							
	6E0906		I-O-3	1	2	CTC-9T0418	82.99
STEERING							
	1U3322		P-UB-10	1-1/2	3	CTC-1856587	60.74
	4T9981		I-O-3	1	2	CTC-9T0418	82.99
	6E0906		I-O-3	1	2	CTC-9T0418	82.99
	6E5392		I-O-3	1	2	CTC-9T0418	82.99
	9T2352		I-O-3	1	2	CTC-9T0418	82.99
TILT							
	4T4666		P-UB-10	2-1/2	4	CTC-1864338	81.62
<b>MODEL IT18B</b>							
LIFT							
	4T5544		I-O-3	1	2	CTC-9T0418	82.99
	4T9981		I-O-3	1	2	CTC-9T0418	82.99
	6E0906		I-O-3	1	2	CTC-9T0418	82.99
	6E5392		I-O-3	1	2	CTC-9T0418	82.99
	6E5393		I-O-3	1	2	CTC-9T0418	82.99
	9T2352		I-O-3	1	2	CTC-9T0418	82.99
	9T5030	Head# 9T5031	P-UB-10	2-1/2	4-3/4	CTC-1328811	161.44
PIN COUPLER							
	4T9981		I-O-3	1	2	CTC-9T0418	82.99
	6E5392		I-O-3	1	2	CTC-9T0418	82.99
	6E5393		I-O-3	1	2	CTC-9T0418	82.99
	9T2352		I-O-3	1	2	CTC-9T0418	82.99
	9T8485		I-O-3	1	2	CTC-9T0418	82.99
SPECIAL APPLICATION							
	4T5544		I-O-3	1	2	CTC-9T0418	82.99
	6E0906		I-O-3	1	2	CTC-9T0418	82.99

CATERPILLAR®



## REPLACEMENT KITS FOR CATERPILLAR® EQUIPMENT

Integrated Toolcarriers							
APPLICATION	CYL #	Misc-Parts, Instructions, etc.	CODE	ROD	BORE	KIT #	List \$
<b>MODEL IT18B</b>							
STEERING							
	1U3322		P-UB-10	1-1/2	3	CTC-1856587	60.74
	9T8485		I-O-3	1	2	CTC-9T0418	82.99
TILT							
	9T5267		P-UB-10	2	4	CTC-1857688	69.64
<b>MODEL IT18F</b>							
LIFT							
	1007020	Head# 1206679	P-UB-10	2-1/2	4-3/4	CTC-1361131	143.18
	1007020	Head# 9T3609	P-UB-10	2-1/2	4-3/4	CTC-1864381	155.36
	1341379		P-UB-10	2-1/2	4-3/4	CTC-1361131	143.18
	9T7044		P-UB-10	2-1/2	4-3/4	CTC-1864381	155.36
	9T8823		I-O-3	1	2	CTC-9T0418	82.99
PIN PULLER							
	6E5393		I-O-3	1	2	CTC-9T0418	82.99
STEERING							
	6E1114		I-O-3	1	2	CTC-9T0418	82.99
	9T2637		P-UB-10	1-1/2	2-3/4	CTC-1361599	106.50
TILT							
	1341380		P-UB-10	2	4	CTC-1857688	69.64
	9T7026		P-UB-10	2	4	CTC-1857688	69.64
<b>MODEL IT24F</b>							
LIFT							
	1007020	Head# 1206679	P-UB-10	2-1/2	4-3/4	CTC-1361131	143.18
	1007020	Head# 9T3609	P-UB-10	2-1/2	4-3/4	CTC-1864381	155.36
	1341379		P-UB-10	2-1/2	4-3/4	CTC-1361131	143.18
	1342327		P-UB-10	2-1/4	4	CTC-1546526	150.74
	9T3937		P-UB-10	2-1/4	4	CTC-1546526	150.74
	9T8823		I-O-3	1	2	CTC-9T0418	82.99
STEERING							
	9T2637		P-UB-10	1-1/2	2-3/4	CTC-1361599	106.50
TILT							
	1107845	Head# 1206679	P-UB-10	2-1/2	4-1/2	CTC-1113300	136.57
	1107845	Head# 9T3609	P-UB-10	2-1/2	4-1/2	CTC-1469860	161.26
	1262492		P-UB-10	2	4	CTC-1113302	118.96
	1262492		P-UB-10	2	4	CTC-1857688	69.64
	1341380		P-UB-10	2	4	CTC-1857688	69.64
	1341381		P-UB-10	2	4	CTC-1857688	69.64
	1342671		P-UB-10	2-1/2	4-1/2	CTC-1113300	136.57
	6E1114		I-O-3	1	2	CTC-9T0418	82.99
	6E4651	Head# 1206679	P-UB-10	2-1/2	4-1/2	CTC-1113300	136.57
	6E4651	Head# 9T3609	P-UB-10	2-1/2	4-1/2	CTC-1469860	161.26
	9T7026		P-UB-10	2	4	CTC-1857688	69.64
<b>MODEL IT28</b>							
LIFT							
	3G2991		P-UB-10	2-1/2	4-3/4	CTC-1328811	161.44
PIN PULLER							
	6E5392		I-O-3	1	2	CTC-9T0418	82.99
	6E5393		I-O-3	1	2	CTC-9T0418	82.99
	9T2352		I-O-3	1	2	CTC-9T0418	82.99
SPECIAL APPLICATION							
	4T5544		I-O-3	1	2	CTC-9T0418	82.99
	6E0906		I-O-3	1	2	CTC-9T0418	82.99

**CATERPILLAR®**



## REPLACEMENT KITS FOR CATERPILLAR® EQUIPMENT

Integrated Toolcarriers							
APPLICATION	CYL #	Misc-Parts, Instructions, etc.	CODE	ROD	BORE	KIT #	List \$
<b>MODEL IT28</b>							
STEERING							
	3G3501		P-UB-10	1-1/2	3	CTC-7X2751	64.04
	4T9981		I-O-3	1	2	CTC-9T0418	82.99
	6E0906		I-O-3	1	2	CTC-9T0418	82.99
	6E5392		I-O-3	1	2	CTC-9T0418	82.99
	9T2352		I-O-3	1	2	CTC-9T0418	82.99
TILT							
	4T5544		I-O-3	1	2	CTC-9T0418	82.99
	4T5545	Head# 8J8431	P-UB-10	2-1/2	4-1/4	CTC-1864336	90.63
	4T5545	Head# 9T6548	P-UB-10	2-1/2	4-1/4	CTC-1864373	102.61
TILT MP, BUCKET							
	4T5545	Head# 8J8431	P-UB-10	2-1/2	4-1/4	CTC-1864336	90.63
	4T5545	Head# 9T6548	P-UB-10	2-1/2	4-1/4	CTC-1864373	102.61
<b>MODEL IT28B</b>							
LIFT							
	3G2991		P-UB-10	2-1/2	4-3/4	CTC-1328811	161.44
	4T8648	Head# 3G2956	P-UB-10	2-1/4	4-1/4	CTC-1859507	111.10
	4T8648	Head# 9T7349	P-UB-10	2-1/4	4-1/4	CTC-1859517	133.49
	9T1196		P-UB-10	2-1/2	5-1/2	CTC-7X2672	88.77
PIN COUPLER							
	4T9981		I-O-3	1	2	CTC-9T0418	82.99
	6E5392		I-O-3	1	2	CTC-9T0418	82.99
	9T2352		I-O-3	1	2	CTC-9T0418	82.99
	9T8485		I-O-3	1	2	CTC-9T0418	82.99
SPECIAL APPLICATION							
	4T5544		I-O-3	1	2	CTC-9T0418	82.99
	6E0906		I-O-3	1	2	CTC-9T0418	82.99
STEERING							
	1U3322		P-UB-10	1-1/2	3	CTC-1856587	60.74
	3G3501		P-UB-10	1-1/2	3	CTC-7X2751	64.04
	3G5110		P-UB-10	1-3/4	3-1/2	CTC-7X2762	100.06
	3G5110		P-UB-10	1-3/4	3-1/2	CTC-7X2784	56.35
	4T9981		I-O-3	1	2	CTC-9T0418	82.99
	6E0906		I-O-3	1	2	CTC-9T0418	82.99
	6E5392		I-O-3	1	2	CTC-9T0418	82.99
	6E5393		I-O-3	1	2	CTC-9T0418	82.99
	9T2352		I-O-3	1	2	CTC-9T0418	82.99
	9T8485		I-O-3	1	2	CTC-9T0418	82.99
TILT							
	3G5291		P-UB-10	2-3/4	6-1/2	CTC-7X2686	120.72
	3G6571		P-UB-10	2-1/2	4-3/4	CTC-1328811	161.44
	4T5544		I-O-3	1	2	CTC-9T0418	82.99
	4T5545	Head# 8J8431	P-UB-10	2-1/2	4-1/4	CTC-1864336	90.63
	4T5545	Head# 9T6548	P-UB-10	2-1/2	4-1/4	CTC-1864373	102.61
TILT MP, BUCKET							
	4T5545	Head# 8J8431	P-UB-10	2-1/2	4-1/4	CTC-1864336	90.63
	4T5545	Head# 9T6548	P-UB-10	2-1/2	4-1/4	CTC-1864373	102.61
<b>MODEL IT28F</b>							
LIFT							
	1341384		P-UB-10	2-1/2	4-3/4	CTC-1361131	143.18
	9T6788	Head# 1206679	P-UB-10	2-1/2	4-3/4	CTC-1361131	143.18
	9T6788	Head# 9T3609	P-UB-10	2-1/2	4-3/4	CTC-1864381	155.36
	9T8823		I-O-3	1	2	CTC-9T0418	82.99
PIN PULLER							
	6E5393		I-O-3	1	2	CTC-9T0418	82.99

CATERPILLAR®



## REPLACEMENT KITS FOR CATERPILLAR® EQUIPMENT

Integrated Toolcarriers							
APPLICATION	CYL #	Misc-Parts, Instructions, etc.	CODE	ROD	BORE	KIT #	List \$
<b>MODEL IT28F</b>							
STEERING							
	6E1114		I-O-3	1	2	CTC-9T0418	82.99
	9T6646		P-UB-10	1-1/2	2-3/4	CTC-1361599	106.50
TILT							
	1341385		P-UB-10	2	4	CTC-1857688	69.64
	9T6929		P-UB-10	2	4	CTC-1857688	69.64
<b>MODEL IT28G</b>							
LIFT							
	1191060		P-UB-10	2-1/2	4-3/4	CTC-1361131	143.18
	6E1114		I-O-3	1	2	CTC-9T0418	82.99
	9T8823		I-O-3	1	2	CTC-9T0418	82.99
STEERING LH							
	1250374		P-UB-10	1-1/2	2-3/4	CTC-1361599	106.50
STEERING RH							
	1250373		P-UB-10	1-1/2	2-3/4	CTC-1856596	46.32
TILT							
	1191852		P-UB-10	2	4	CTC-1857688	69.64
	1273020		P-UB-10	2	4	CTC-1857688	69.64
<b>MODEL IT38F</b>							
LIFT							
	1148131		P-UB-10	3	4-3/4	CTC-1915030	162.01
STEERING							
	1050094		P-UB-10	1-3/4	3	CTC-1857025	49.97
TILT							
	1156963		P-UB-10	2-3/4	4-1/2	CTC-1933117	111.56
<b>MODEL IT38G</b>							
LIFT							
	1148131		P-UB-10	3	4-3/4	CTC-1570288	172.37
	1CW1-UP; 7BS1-UP						
	1148131		P-UB-10	3	4-3/4	CTC-2275349	194.23
STEERING							
	1050094		P-UB-10	1-3/4	3	CTC-7X2825	53.69
	1393312		P-UB-10	1-3/4	3	CTC-7X2825	53.69
TILT							
	1156963		P-UB-10	2-3/4	4-1/2	CTC-1636105	161.51
	1CW1-UP; 7BS1-UP						
	1156963		P-UB-10	2-3/4	4-1/2	CTC-2275348	120.33
<b>MODEL IT62G</b>							
LIFT RH							
	1188296		P-UB-10	3	6	CTC-7X2698	186.32
	1250024		P-UB-10	3	6	CTC-7X2698	186.32
STEERING							
	1188288		P-UB-10	1-3/4	3-1/2	CTC-7X2784	56.35
TILT							
	1349397		P-UB-10	3	5-1/4	CTC-3E3293	177.73
<b>Landfill Compactors</b>							
APPLICATION	CYL #	Misc-Parts, Instructions, etc.	CODE	ROD	BORE	KIT #	List \$
<b>MODEL 816</b>							
LIFT							
	1U2088		P-UB-10	2-1/2	4-3/4	CTC-7X2660	179.61
	4J9233		P-V-10	2	4-1/2	CTC-7X2770	97.94
STEERING							
	4T1574		P-UB-10	2	4	CTC-7X2789	102.01
STEERING LH							
	7J9356		P-UB-10	2	4	CTC-7X2755	147.15
STEERING RH							
	7J9355		P-UB-10	2	4	CTC-7X2755	147.15



## REPLACEMENT KITS FOR CATERPILLAR® EQUIPMENT

<b>Landfill Compactors</b>							
APPLICATION	CYL #	Misc-Parts, Instructions, etc.	CODE	ROD	BORE	KIT #	List \$
<b>MODEL 816B</b>							
DOZER							
	1U2088		P-UB-10	2-1/2	4-3/4	CTC-1328811	161.44
DOZER LIFT							
	1U2088		P-UB-10	2-1/2	4-3/4	CTC-7X2660	179.61
STEERING							
	4T1574		P-UB-10	2	4	CTC-1328816	92.75
	6E5024		P-UB-10	2	4	CTC-1113302	118.96
STEERING LH							
	7J9356		P-UB-10	2	4	CTC-7X2755	147.15
<b>MODEL 816F</b>							
DOZER							
	1U2088		P-UB-10	2-1/2	4-3/4	CTC-1328811	161.44
STEERING							
	4T1574		P-UB-10	2	4	CTC-1328816	92.75
	6E5024		P-UB-10	2	4	CTC-1113302	118.96
<b>MODEL 826B</b>							
LIFT							
	7K9401		P-UB-10	2-1/4	5	CTC-7X2729	162.34
	8J2650		P-UB-10	2	4-1/2	CTC-7X2768	88.67
	9J7111		P-UB-10	2-1/2	5-1/2	CTC-7X2653	162.45
STEERING							
	7J9718		P-UB-10	2-1/4	5	CTC-7X2729	162.34
STEERING LH							
	9J7087		P-UB-10	2-1/4	5	CTC-7X2729	162.34
STEERING RH							
	9J7086		P-UB-10	2-1/4	5	CTC-7X2729	162.34
<b>MODEL 826C</b>							
LIFT							
	8J2650		P-UB-10	2	4-1/2	CTC-7X2768	88.67
	9J7111		P-UB-10	2-1/2	5-1/2	CTC-7X2653	162.45
STEERING							
	9J7086		P-UB-10	2-1/4	5	CTC-9X6392	160.01
	9J7087		P-UB-10	2-1/4	5	CTC-9X6392	160.01
<b>MODEL 826G</b>							
DOZER							
	1164842		P-UB-10	3	4-3/4	CTC-1570288	172.37
STEERING							
	1175151		P-UB-10	2-1/2	4-1/2	CTC-1113300	136.57
<b>MODEL 836, 836C</b>							
LIFT							
	6J1272		P-V-10	2-1/2	6-1/2	CTC-7X2676	109.43
STEERING							
	9J8165		P-UB-10	2-1/4	5	CTC-9X6392	160.01
<b>Loaders - Skid Steer</b>							
APPLICATION	CYL #	Misc-Parts, Instructions, etc.	CODE	ROD	BORE	KIT #	List \$
<b>MODEL 226</b>							
ANGLE BLADE							
	5FZ1-UP						
	2259521		P-U-10	32 mm	63 mm	CTC-1771958	69.13
BUCKET							
	5FZ1-UP						
	2781969		I-U-10	30 mm	60 mm	CTC-2781970	48.73
	2936264		I-U-10	30 mm	50 mm	CTC-2620941	25.18
BUCKET MP							
	5FZ1-UP						
	1545018		P-U-10	30 mm	60 mm	CTC-1643213	66.37

**CATERPILLAR®**



## REPLACEMENT KITS FOR CATERPILLAR® EQUIPMENT

Loaders - Skid Steer							
APPLICATION	CYL #	Misc-Parts, Instructions, etc.	CODE	ROD	BORE	KIT #	List \$
<b>MODEL 226</b>							
GRAPPLE							
5FZ1-11443							
	2781975		I-U-10	30 mm	60 mm	CTC-2781970	48.73
5FZ1-UP							
	1565512		P-U-10	30 mm	60 mm	CTC-1643213	66.37
	1649295		P-U-10	25 mm	40 mm	CTC-1725285	57.03
LIFT LH							
5FZ1-UP							
	1428961		I-U-10	35 mm	50 mm	CTC-1428962	49.88
LIFT RH							
5FZ1-UP							
	1428960		I-U-10	35 mm	50 mm	CTC-1428962	49.88
TILT LH							
5FZ1-2158							
	1428956		P-U-10	30 mm	65 mm	CTC-1428963	98.98
5FZ2159-UP							
	1779569		P-U-10	30 mm	65 mm	CTC-1428963	98.98
TILT RH							
5FZ1-2158							
	1428955		P-U-10	30 mm	65 mm	CTC-1428963	98.98
5FZ2159-UP							
	1779568		P-U-10	30 mm	65 mm	CTC-1428963	98.98
<b>MODEL 226B</b>							
ANGLE BLADE							
MJH1-UP							
	2259521		P-U-10	32 mm	63 mm	CTC-1771958	69.13
	2749930		I-U-10	35 mm	70 mm	CTC-2666140	40.95
BUCKET							
MJH1-10574							
	1545018		P-U-10	30 mm	60 mm	CTC-1643213	66.37
	2781969		I-U-10	30 mm	60 mm	CTC-2781970	48.73
	2936264		I-U-10	30 mm	50 mm	CTC-2620941	25.18
GRAPPLE							
MJH1-10574							
	1565512		P-U-10	30 mm	60 mm	CTC-1643213	66.37
	1649295		P-U-10	25 mm	40 mm	CTC-1725285	57.03
	2781975		I-U-10	30 mm	60 mm	CTC-2781970	48.73
LIFT LH							
MJH1-10574							
	2303683		P-U-10	35 mm	50 mm	CTC-2186826	38.07
LIFT RH							
MJH1-10574							
	2303693		P-U-10	35 mm	50 mm	CTC-2186826	38.07
TILT							
MJH1-UP							
	2749931		I-U-10	35 mm	70 mm	CTC-2666140	40.95
TILT LH							
MJH1-10574							
	2303684		P-U-10	30 mm	65 mm	CTC-2186825	51.44
TILT RH							
MJH1-10574							
	2303694		P-U-10	30 mm	65 mm	CTC-2186825	51.44
<b>MODEL 226B2</b>							
BUCKET							
MJH10575-UP							
	2781969		I-U-10	30 mm	60 mm	CTC-2781970	48.73
	2936264		I-U-10	30 mm	50 mm	CTC-2620941	25.18

CATERPILLAR®



## REPLACEMENT KITS FOR CATERPILLAR® EQUIPMENT

Loaders - Skid Steer							
APPLICATION	CYL #	Misc-Parts, Instructions, etc.	CODE	ROD	BORE	KIT #	List \$
<b>MODEL 226B2</b>							
GRAPPLE							
MJH10575-UP							
	1649295		P-U-10	25 mm	40 mm	CTC-1725285	57.03
	2781975		I-U-10	30 mm	60 mm	CTC-2781970	48.73
GRAPPLE RH							
MJH10575-UP							
	2550943		I-U-10	25 mm	40 mm	CTC-2863591	20.64
LIFT LH							
MJH10575-15087;15094-15156							
	2303683		P-U-10	35 mm	50 mm	CTC-2186826	38.07
MJH15088-15093;15157-UP							
	2935706		P-U-10	35 mm	50 mm	CTC-3712697	41.21
LIFT RH							
MJH10575-15087;15094-15156							
	2303693		P-U-10	35 mm	50 mm	CTC-2186826	38.07
MJH15088-15093;15157-UP							
	2935705		P-U-10	35 mm	50 mm	CTC-3712697	41.21
TILT LH							
MJH10575-15087;15094-15156							
	2303684		P-U-10	30 mm	65 mm	CTC-2186825	51.44
TILT RH							
MJH10575-15087;15094-15156							
	2303694		P-U-10	30 mm	65 mm	CTC-2186825	51.44
MJH15088-15093;15157-UP							
	2935707		P-U-10	30 mm	65 mm	CTC-3712718	37.86
<b>MODEL 236</b>							
ANGLE BLADE							
4YZ1-UP							
	2259521		P-U-10	32 mm	63 mm	CTC-1771958	69.13
4YZ4000-UP							
	2749930		I-U-10	35 mm	70 mm	CTC-2666140	40.95
BUCKET							
4YZ1-UP							
	1545018		P-U-10	30 mm	60 mm	CTC-1643213	66.37
	2781969		I-U-10	30 mm	60 mm	CTC-2781970	48.73
4YZ4000-UP							
	2936264		I-U-10	30 mm	50 mm	CTC-2620941	25.18
GRAPPLE							
4YZ1-UP							
	1565512		P-U-10	30 mm	60 mm	CTC-1643213	66.37
	1649295		P-U-10	25 mm	40 mm	CTC-1725285	57.03
	2781975		I-U-10	30 mm	60 mm	CTC-2781970	48.73
LIFT LH							
4YZ1-UP							
	1429196		P-U-10	35 mm	70 mm	CTC-1429192	48.06
	1429196		P-U-10	40 mm	60 mm	CTC-1429193	73.58
LIFT RH							
4YZ1-UP							
	1429195		P-U-10	35 mm	70 mm	CTC-1429192	48.06
	1429195		P-U-10	40 mm	60 mm	CTC-1429193	73.58
TILT							
47Z4000-UP							
	2749931		I-U-10	35 mm	70 mm	CTC-2666140	40.95
TILT LH							
4YZ1-UP							
	1779566		P-U-10	35 mm	70 mm	CTC-1429192	48.06

CATERPILLAR®





## REPLACEMENT KITS FOR CATERPILLAR® EQUIPMENT

Loaders - Skid Steer							
APPLICATION	CYL #	Misc-Parts, Instructions, etc.	CODE	ROD	BORE	KIT #	List \$
<b>MODEL 236</b>							
TILT RH							
4YZ1-UP							
	1779565		P-U-10	35 mm	70 mm	CTC-1429192	48.06
<b>MODEL 236B</b>							
ANGLE BLADE							
HEN1-6749							
	2259521		P-U-10	32 mm	63 mm	CTC-1771958	69.13
	2749930		I-U-10	35 mm	70 mm	CTC-2666140	40.95
BUCKET							
HEN1-6749							
	1545018		P-U-10	30 mm	60 mm	CTC-1643213	66.37
	2781969		I-U-10	30 mm	60 mm	CTC-2781970	48.73
	2936264		I-U-10	30 mm	50 mm	CTC-2620941	25.18
GRAPPLE							
HEN1-6749							
	1565512		P-U-10	30 mm	60 mm	CTC-1643213	66.37
	1649295		P-U-10	25 mm	40 mm	CTC-1725285	57.03
	2781975		I-U-10	30 mm	60 mm	CTC-2781970	48.73
LIFT LH							
HEN1-6749							
	2303685		P-U-10	40 mm	60 mm	CTC-2186823	59.26
LIFT RH							
HEN1-6749							
	2303695		P-U-10	40 mm	60 mm	CTC-2186823	59.26
TILT							
HEN1-6749							
	2749931		I-U-10	35 mm	70 mm	CTC-2666140	40.95
TILT LH							
HEN1-6749							
	2303687		P-U-10	35 mm	70 mm	CTC-2186822	73.84
TILT RH							
HEN1-6749							
	2303697		P-U-10	35 mm	70 mm	CTC-2186822	73.84
<b>MODEL 236B2</b>							
ANGLE BLADE							
HEN6750-UP							
	2259521		P-U-10	32 mm	63 mm	CTC-1771958	69.13
	2749930		I-U-10	35 mm	70 mm	CTC-2666140	40.95
BUCKET							
HEN6750-UP							
	2781969		I-U-10	30 mm	60 mm	CTC-2781970	48.73
	2936264		I-U-10	30 mm	50 mm	CTC-2620941	25.18
GRAPPLE							
HEN6750-UP							
	1649295		P-U-10	25 mm	40 mm	CTC-1725285	57.03
	2550943		I-U-10	25 mm	40 mm	CTC-2863591	20.64
	2781975		I-U-10	30 mm	60 mm	CTC-2781970	48.73
LIFT LH							
HEN6750-9767							
	2303685		P-U-10	40 mm	60 mm	CTC-2186823	59.26
HEN9768-UP							
	2956952		P-U-10	40 mm	60 mm	CTC-3712756	41.89
LIFT RH							
HEN6750-9767							
	2303695		P-U-10	40 mm	60 mm	CTC-2186823	59.26
HEN9768-UP							
	2956951		P-U-10	40 mm	60 mm	CTC-3712756	41.89

**CATERPILLAR®**



## REPLACEMENT KITS FOR CATERPILLAR® EQUIPMENT

Loaders - Skid Steer							
APPLICATION	CYL #	Misc-Parts, Instructions, etc.	CODE	ROD	BORE	KIT #	List \$
<b>MODEL 236B2</b>							
TILT							
HEN6750-UP							
	2749931		I-U-10	35 mm	70 mm	CTC-2666140	40.95
TILT LH							
HEN6750-9765							
	2303687		P-U-10	35 mm	70 mm	CTC-2186822	73.84
HEN9766-UP							
	2956954		P-U-10	35 mm	70 mm	CTC-3712760	42.71
TILT RH							
HEN6750-9765							
	2303697		P-U-10	35 mm	70 mm	CTC-2186822	73.84
HEN9766-UP							
	2956953		P-U-10	35 mm	70 mm	CTC-3712760	42.71
<b>MODEL 242</b>							
ANGLE BLADE							
CMB1-UP							
	2259521		P-U-10	32 mm	63 mm	CTC-1771958	69.13
BUCKET							
CMB1-UP							
	1545018		P-U-10	30 mm	60 mm	CTC-1643213	66.37
	2781969		I-U-10	30 mm	60 mm	CTC-2781970	48.73
	2936264		I-U-10	30 mm	50 mm	CTC-2620941	25.18
GRAPPLE							
CMB1-1646							
	2781975		I-U-10	30 mm	60 mm	CTC-2781970	48.73
CMB1-UP							
	1565512		P-U-10	30 mm	60 mm	CTC-1643213	66.37
	1649295		P-U-10	25 mm	40 mm	CTC-1725285	57.03
LIFT							
CMB1-UP							
	1919641		P-U-10	45 mm	60 mm	CTC-1919605	71.53
TILT LH							
CMB1-UP							
	1779569		P-U-10	30 mm	65 mm	CTC-1428963	98.98
TILT RH							
CMB1-UP							
	1779568		P-U-10	30 mm	65 mm	CTC-1428963	98.98
<b>MODEL 242B</b>							
ANGLE BLADE							
BXM1-4224							
	2259521		P-U-10	32 mm	63 mm	CTC-1771958	69.13
	2749930		I-U-10	35 mm	70 mm	CTC-2666140	40.95
BUCKET							
BXM1-4224							
	1545018		P-U-10	30 mm	60 mm	CTC-1643213	66.37
	2781969		I-U-10	30 mm	60 mm	CTC-2781970	48.73
	2936264		I-U-10	30 mm	50 mm	CTC-2620941	25.18
GRAPPLE							
BXM1-4224							
	1565512		P-U-10	30 mm	60 mm	CTC-1643213	66.37
	1649295		P-U-10	25 mm	40 mm	CTC-1725285	57.03
	2781975		I-U-10	30 mm	60 mm	CTC-2781970	48.73
LIFT							
BXM1-4224							
	2303703		P-U-10	45 mm	60 mm	CTC-2186827	57.43

CATERPILLAR®



## REPLACEMENT KITS FOR CATERPILLAR® EQUIPMENT

Loaders - Skid Steer							
APPLICATION	CYL #	Misc-Parts, Instructions, etc.	CODE	ROD	BORE	KIT #	List \$
<b>MODEL 242B</b>							
TILT							
BX1-4224							
	2749931		I-U-10	35 mm	70 mm	CTC-2666140	40.95
TILT LH							
BX1-4224							
	2303684		P-U-10	30 mm	65 mm	CTC-2186825	51.44
TILT RH							
BX1-4224							
	2303694		P-U-10	30 mm	65 mm	CTC-2186825	51.44
<b>MODEL 242B2</b>							
ANGLE BLADE							
BX4225-UP							
	2259521		P-U-10	32 mm	63 mm	CTC-1771958	69.13
	2749930		I-U-10	35 mm	70 mm	CTC-2666140	40.95
BUCKET							
BX4225-UP							
	2781969		I-U-10	30 mm	60 mm	CTC-2781970	48.73
	2936264		I-U-10	30 mm	50 mm	CTC-2620941	25.18
GRAPPLE							
BX4225-UP							
	1649295		P-U-10	25 mm	40 mm	CTC-1725285	57.03
	2781975		I-U-10	30 mm	60 mm	CTC-2781970	48.73
GRAPPLE RH							
BX4225-UP							
	2550943		I-U-10	25 mm	40 mm	CTC-2863591	20.64
LIFT							
BX4225-UP							
	2303703		P-U-10	45 mm	60 mm	CTC-2186827	57.43
TILT							
BX4225-UP							
	2749931		I-U-10	35 mm	70 mm	CTC-2666140	40.95
TILT LH							
BX4225-UP							
	2303684		P-U-10	30 mm	65 mm	CTC-2186825	51.44
TILT RH							
BX4225-UP							
	2303694		P-U-10	30 mm	65 mm	CTC-2186825	51.44
<b>MODEL 246</b>							
ANGLE BLADE							
5SZ1-UP							
	2259521		P-U-10	32 mm	63 mm	CTC-1771958	69.13
5SZ4000-UP							
	2749930		I-U-10	35 mm	70 mm	CTC-2666140	40.95
BUCKET							
5SZ1-UP							
	1545018		P-U-10	30 mm	60 mm	CTC-1643213	66.37
	2781969		I-U-10	30 mm	60 mm	CTC-2781970	48.73
5SZ4000-UP							
	2936264		I-U-10	30 mm	50 mm	CTC-2620941	25.18
GRAPPLE							
5SZ1-UP							
	1565512		P-U-10	30 mm	60 mm	CTC-1643213	66.37
	1649295		P-U-10	25 mm	40 mm	CTC-1725285	57.03
	2781975		I-U-10	30 mm	60 mm	CTC-2781970	48.73

**CATERPILLAR®**



## REPLACEMENT KITS FOR CATERPILLAR® EQUIPMENT

Loaders - Skid Steer							
APPLICATION	CYL #	Misc-Parts, Instructions, etc.	CODE	ROD	BORE	KIT #	List \$
<b>MODEL 246</b>							
LIFT LH							
5SZ1-UP							
	1429196		P-U-10	35 mm	70 mm	CTC-1429192	48.06
	1429196		P-U-10	40 mm	60 mm	CTC-1429193	73.58
LIFT RH							
5SZ1-UP							
	1429195		P-U-10	35 mm	70 mm	CTC-1429192	48.06
	1429195		P-U-10	40 mm	60 mm	CTC-1429193	73.58
TILT							
5SZ4000-UP							
	2749931		I-U-10	35 mm	70 mm	CTC-2666140	40.95
TILT LH							
5SZ1-UP							
	1779566		P-U-10	35 mm	70 mm	CTC-1429192	48.06
TILT RH							
5SZ1-UP							
	1779565		P-U-10	35 mm	70 mm	CTC-1429192	48.06
<b>MODEL 246B</b>							
ANGLE BLADE							
PAT1-UP							
	2259521		P-U-10	32 mm	63 mm	CTC-1771958	69.13
	2749930		I-U-10	35 mm	70 mm	CTC-2666140	40.95
BUCKET							
PAT1-UP							
	1545018		P-U-10	30 mm	60 mm	CTC-1643213	66.37
	2781969		I-U-10	30 mm	60 mm	CTC-2781970	48.73
	2936264		I-U-10	30 mm	50 mm	CTC-2620941	25.18
GRAPPLE							
PAT1-UP							
	1565512		P-U-10	30 mm	60 mm	CTC-1643213	66.37
	1649295		P-U-10	25 mm	40 mm	CTC-1725285	57.03
	2781975		I-U-10	30 mm	60 mm	CTC-2781970	48.73
LIFT LH							
PAT1-UP							
	2303685		P-U-10	40 mm	60 mm	CTC-2186823	59.26
LIFT RH							
PAT1-UP							
	2303695		P-U-10	40 mm	60 mm	CTC-2186823	59.26
TILT							
PAT1-UP							
	2749931		I-U-10	35 mm	70 mm	CTC-2666140	40.95
TILT LH							
PAT1-UP							
	2303687		P-U-10	35 mm	70 mm	CTC-2186822	73.84
TILT RH							
PAT1-UP							
	2303697		P-U-10	35 mm	70 mm	CTC-2186822	73.84
<b>MODEL 246C</b>							
ANGLE BLADE							
JAY1-UP							
	2259521		P-U-10	32 mm	63 mm	CTC-1771958	69.13
	2749930		I-U-10	35 mm	70 mm	CTC-2666140	40.95
BUCKET							
JAY1-UP							
	1545018		P-U-10	30 mm	60 mm	CTC-1643213	66.37
	2781969		I-U-10	30 mm	60 mm	CTC-2781970	48.73
	2936264		I-U-10	30 mm	50 mm	CTC-2620941	25.18

**CATERPILLAR®**



## REPLACEMENT KITS FOR CATERPILLAR® EQUIPMENT

Loaders - Skid Steer							
APPLICATION	CYL #	Misc-Parts, Instructions, etc.	CODE	ROD	BORE	KIT #	List \$
<b>MODEL 246C</b>							
GRAPPLE							
JAY1-UP							
	1649295		P-U-10	25 mm	40 mm	CTC-1725285	57.03
	2550943		I-U-10	25 mm	40 mm	CTC-2863591	20.64
	2781975		I-U-10	30 mm	60 mm	CTC-2781970	48.73
LIFT							
JAY1-4094;4096-4202							
	2582512		P-U-10	45 mm	65 mm	CTC-2186824	51.03
JAY4095;4203-UP							
	2935710		P-U-10	45 mm	65 mm	CTC-3712737	39.25
TILT							
JAY1-UP							
	2749931		I-U-10	35 mm	70 mm	CTC-2666140	40.95
TILT LH							
JAY1-4094;4096-4215							
	2582515		P-U-10	35 mm	75 mm	CTC-2583621	43.31
JAY4095;4216-UP							
	2935712		P-U-10	35 mm	75 mm	CTC-3712751	45.35
TILT RH							
JAY1-4094;4096-4215							
	2582514		P-U-10	35 mm	75 mm	CTC-2583621	43.31
JAY4095;4216-UP							
	2935711		P-U-10	35 mm	75 mm	CTC-3712751	45.35
<b>MODEL 252B</b>							
ANGLE BLADE							
SCP1-4599							
	2259521		P-U-10	32 mm	63 mm	CTC-1771958	69.13
	2749930		I-U-10	35 mm	70 mm	CTC-2666140	40.95
BUCKET							
SCP1-4599							
	1545018		P-U-10	30 mm	60 mm	CTC-1643213	66.37
	2781969		I-U-10	30 mm	60 mm	CTC-2781970	48.73
	2936264		I-U-10	30 mm	50 mm	CTC-2620941	25.18
GRAPPLE							
SCP1-4599							
	1565512		P-U-10	30 mm	60 mm	CTC-1643213	66.37
	1649295		P-U-10	25 mm	40 mm	CTC-1725285	57.03
	2781975		I-U-10	30 mm	60 mm	CTC-2781970	48.73
LIFT							
SCP1-4599							
	2303705		P-U-10	45 mm	65 mm	CTC-2186824	51.03
TILT							
SCP1-4599							
	2749931		I-U-10	35 mm	70 mm	CTC-2666140	40.95
TILT LH							
SCP1-4599							
	2303687		P-U-10	35 mm	70 mm	CTC-2186822	73.84
TILT RH							
SCP1-4599							
	2303697		P-U-10	35 mm	70 mm	CTC-2186822	73.84
<b>MODEL 252B2</b>							
ANGLE BLADE							
SCP4600-UP							
	2259521		P-U-10	32 mm	63 mm	CTC-1771958	69.13
	2749930		I-U-10	35 mm	70 mm	CTC-2666140	40.95

CATERPILLAR®



## REPLACEMENT KITS FOR CATERPILLAR® EQUIPMENT

Loaders - Skid Steer							
APPLICATION	CYL #	Misc-Parts, Instructions, etc.	CODE	ROD	BORE	KIT #	List \$
<b>MODEL 252B2</b>							
BUCKET							
SCP4600-UP							
	2781969		I-U-10	30 mm	60 mm	CTC-2781970	48.73
	2936264		I-U-10	30 mm	50 mm	CTC-2620941	25.18
GRAPPLE							
SCP4600-UP							
	1649295		P-U-10	25 mm	40 mm	CTC-1725285	57.03
	2550943		I-U-10	25 mm	40 mm	CTC-2863591	20.64
	2781975		I-U-10	30 mm	60 mm	CTC-2781970	48.73
LIFT							
SCP4600-UP							
	2303705		P-U-10	45 mm	65 mm	CTC-2186824	51.03
SCP6188-UP							
	2978699		P-U-10	45 mm	65 mm	CTC-3712737	39.25
TILT							
SCP4600-UP							
	2749931		I-U-10	35 mm	70 mm	CTC-2666140	40.95
TILT LH							
SCP4600-6187							
	2303687		P-U-10	35 mm	70 mm	CTC-2186822	73.84
SCP6188-UP							
	2956954		P-U-10	35 mm	70 mm	CTC-3712760	42.71
TILT RH							
SCP4600-6187							
	2303697		P-U-10	35 mm	70 mm	CTC-2186822	73.84
SCP6188-UP							
	2956953		P-U-10	35 mm	70 mm	CTC-3712760	42.71
<b>MODEL 262</b>							
ANGLE BLADE							
CED1-UP							
	2259521		P-U-10	32 mm	63 mm	CTC-1771958	69.13
	2749930		I-U-10	35 mm	70 mm	CTC-2666140	40.95
BUCKET							
CED1-UP							
	1545018		P-U-10	30 mm	60 mm	CTC-1643213	66.37
	2781969		I-U-10	30 mm	60 mm	CTC-2781970	48.73
	2936264		I-U-10	30 mm	50 mm	CTC-2620941	25.18
GRAPPLE							
CED1-UP							
	1565512		P-U-10	30 mm	60 mm	CTC-1643213	66.37
	1649295		P-U-10	25 mm	40 mm	CTC-1725285	57.03
	2781975		I-U-10	30 mm	60 mm	CTC-2781970	48.73
LIFT							
CED1-UP							
	1908041		P-U-10	45 mm	65 mm	CTC-2063805	98.23
TILT							
CED1-UP							
	2749931		I-U-10	35 mm	70 mm	CTC-2666140	40.95
TILT LH							
CED1-UP							
	1779566		P-U-10	35 mm	70 mm	CTC-1429192	48.06
TILT RH							
CED1-UP							
	1779565		P-U-10	35 mm	70 mm	CTC-1429192	48.06

CATERPILLAR®



## REPLACEMENT KITS FOR CATERPILLAR® EQUIPMENT

Loaders - Skid Steer							
APPLICATION	CYL #	Misc-Parts, Instructions, etc.	CODE	ROD	BORE	KIT #	List \$
<b>MODEL 262B</b>							
<b>ANGLE BLADE</b>							
PDT1-UP							
	2259521		P-U-10	32 mm	63 mm	CTC-1771958	69.13
	2749930		I-U-10	35 mm	70 mm	CTC-2666140	40.95
<b>BUCKET</b>							
PDT1-UP							
	1545018		P-U-10	30 mm	60 mm	CTC-1643213	66.37
	2781969		I-U-10	30 mm	60 mm	CTC-2781970	48.73
	2936264		I-U-10	30 mm	50 mm	CTC-2620941	25.18
<b>GRAPPLE</b>							
PDT1-UP							
	1565512		P-U-10	30 mm	60 mm	CTC-1643213	66.37
	1649295		P-U-10	25 mm	40 mm	CTC-1725285	57.03
	2781975		I-U-10	30 mm	60 mm	CTC-2781970	48.73
<b>LIFT</b>							
PDT1-UP							
	2303705		P-U-10	45 mm	65 mm	CTC-2186824	51.03
<b>TILT</b>							
PDT1-UP							
	2749931		I-U-10	35 mm	70 mm	CTC-2666140	40.95
<b>TILT LH</b>							
PDT1-UP							
	2303687		P-U-10	35 mm	70 mm	CTC-2186822	73.84
<b>TILT RH</b>							
PDT1-UP							
	2303697		P-U-10	35 mm	70 mm	CTC-2186822	73.84
<b>MODEL 262C</b>							
<b>ANGLE BLADE</b>							
MST1-UP							
	225952		P-U-10	32 mm	63 mm	CTC-1771958	69.13
	2749930		I-U-10	35 mm	70 mm	CTC-2666140	40.95
<b>BUCKET</b>							
MST1-UP							
	1545018		P-U-10	30 mm	60 mm	CTC-1643213	66.37
	2781969		I-U-10	30 mm	60 mm	CTC-2781970	48.73
	2936264		I-U-10	30 mm	50 mm	CTC-2620941	25.18
<b>GRAPPLE</b>							
MST1-UP							
	1649295		P-U-10	25 mm	40 mm	CTC-1725285	57.03
	2550943		I-U-10	25 mm	40 mm	CTC-2863591	20.64
	2781975		I-U-10	30 mm	60 mm	CTC-2781970	48.73
<b>LIFT</b>							
MST1-3376							
	2582516		P-U-10	45 mm	65 mm	CTC-2186824	51.03
MST1860-UP							
	2935713		P-U-10	45 mm	65 mm	CTC-3712737	39.25
<b>TILT</b>							
MST1-UP							
	2749931		I-U-10	35 mm	70 mm	CTC-2666140	40.95
<b>TILT LH</b>							
MST1-3357							
	2582515		P-U-10	35 mm	75 mm	CTC-2583621	43.31
MST1860-UP							
	2935712		P-U-10	35 mm	75 mm	CTC-3712751	45.35
<b>TILT RH</b>							
MST1-3357							
	2582514		P-U-10	35 mm	75 mm	CTC-2583621	43.31

CATERPILLAR®





## REPLACEMENT KITS FOR CATERPILLAR® EQUIPMENT

Loaders - Skid Steer							
APPLICATION	CYL #	Misc-Parts, Instructions, etc.	CODE	ROD	BORE	KIT #	List \$
<b>MODEL 262C</b>							
TILT RH							
	MST1860-UP						
	2935711		P-U-10	35 mm	75 mm	CTC-3712751	45.35
<b>MODEL 268B</b>							
ANGLE BLADE							
	LBA1-UP						
	2259521		P-U-10	32 mm	63 mm	CTC-1771958	69.13
BUCKET							
	LBA1-UP						
	1545018		P-U-10	30 mm	60 mm	CTC-1643213	66.37
	2781969		I-U-10	30 mm	60 mm	CTC-2781970	48.73
	2936264		I-U-10	30 mm	50 mm	CTC-2620941	25.18
GRAPPLE							
	LBA1-UP						
	1565512		P-U-10	30 mm	60 mm	CTC-1643213	66.37
	1649295		P-U-10	25 mm	40 mm	CTC-1725285	57.03
	2550943		I-U-10	25 mm	40 mm	CTC-2863591	20.64
	2781975		I-U-10	30 mm	60 mm	CTC-2781970	48.73
LIFT							
	LBA1-UP						
	2303705		P-U-10	45 mm	65 mm	CTC-2186824	51.03
TILT LH							
	LBA1-UP						
	2303687		P-U-10	35 mm	70 mm	CTC-2186822	73.84
TILT RH							
	LBA1-UP						
	2303697		P-U-10	35 mm	70 mm	CTC-2186822	73.84
Loaders - Wheel							
APPLICATION	CYL #	Misc-Parts, Instructions, etc.	CODE	ROD	BORE	KIT #	List \$
<b>MODEL 902</b>							
UNSPECIFIED APPLICATION							
	9T4006		P-UB-10	1-1/2	3	CTC-7X2737	108.60
<b>MODEL 904</b>							
LIFT							
	4T8580		P-UB-10	2	3-3/4	CTC-7X2787	103.33
STEERING							
	1U4666		P-UB-10	1-1/2	2-3/4	CTC-7X2749	59.06
TILT							
	4T8581		P-UB-10	1-3/4	3-1/4	CTC-7X2764	68.76
<b>MODEL 906</b>							
BUCKET GRAPPLE							
	1649430		P-UB-10	1-1/4	2-1/2	CTC-1649430K	49.20
LIFT							
	1344485		P-UB-10	55 mm	100 mm	CTC-1344485K	117.98
MULTIPURPOSE BUCKET							
	1349838		P-UB-10	35 mm	70 mm	CTC-1349838K	156.52
	9T4006		P-UB-10	1-1/2	3	CTC-1856583	45.80
SIDE DUMP							
	1250373		P-UB-10	1-1/2	2-3/4	CTC-1856596	46.32
STEERING							
	1349838		P-UB-10	35 mm	70 mm	CTC-1349838K	156.52
STEERING RH							
	1250373		P-UB-10	1-1/2	2-3/4	CTC-1856596	46.32
TILT							
	1350532		P-UB-10	50 mm	85 mm	CTC-1350532K	215.01

**CATERPILLAR®**



## REPLACEMENT KITS FOR CATERPILLAR® EQUIPMENT

Loaders - Wheel							
APPLICATION	CYL #	Misc-Parts, Instructions, etc.	CODE	ROD	BORE	KIT #	List \$
<b>MODEL 908</b>							
HIGH DUMP							
	1349848		P-UB-10	35 mm	70 mm	CTC-1349838K	156.52
MULTIPURPOSE BUCKET							
	9T4006		P-UB-10	1-1/2	3	CTC-1856583	45.80
SIDE DUMP							
	1250373		P-UB-10	1-1/2	2-3/4	CTC-1856596	46.32
<b>MODEL 910</b>							
BUCKET							
	8J5391		P-UB-10	1-1/2	3-1/2	CTC-7X2752	95.40
LIFT							
	7J5893		P-UB-10	2	4	CTC-1328816	92.75
	7J5894		P-UB-10	2	4	CTC-1328816	92.75
STEERING							
	1U4666		P-UB-10	1-1/2	2-3/4	CTC-7X2736	126.39
	1U4666		P-UB-10	1-1/2	2-3/4	CTC-8T1402	49.56
	8J0070		P-UB-10	1-1/2	2-3/4	CTC-7X2749	59.06
	9T5153		P-UB-10	1-1/2	2-3/4	CTC-7X2736	126.39
	9T7209		P-UB-10	1-1/2	2-3/4	CTC-1361599	106.50
	9T7210		P-UB-10	1-1/2	2-3/4	CTC-1361599	106.50
STEERING LH							
	6E5973		P-UB-10	1-1/2	2-3/4	CTC-1361599	106.50
STEERING RH							
	6E5985		P-UB-10	1-1/2	2-3/4	CTC-1361599	106.50
TILT							
	1U3164		P-UB-10	1-3/4	3-1/4	CTC-7X2764	68.76
	1U3165		P-UB-10	1-3/4	3-1/4	CTC-1328770	120.66
	7J5885		P-UB-10	1-3/4	3	CTC-7X2791	88.60
	9J7905		P-UB-10	1-3/4	3	CTC-7X2791	88.60
TILT EXT'D DUMP							
	1U3164		P-UB-10	1-3/4	3-1/4	CTC-7X2764	68.76
TOOL BAR							
	4H6711		P-V-10	1-1/4	4	CTC-8T1480	82.72
<b>MODEL 910E, 910F</b>							
BUCKET							
	8J5391		P-UB-10	1-1/2	3-1/2	CTC-7X2752	95.40
LIFT							
	6E5969		P-UB-10	2-1/4	4	CTC-1361171	101.36
	9T5745		P-UB-10	2-1/4	4	CTC-1361171	101.36
STEERING							
	9T7209		P-UB-10	1-1/2	2-3/4	CTC-1361599	106.50
	9T7210		P-UB-10	1-1/2	2-3/4	CTC-1361599	106.50
STEERING LH							
	6E5900		P-UB-10	1-3/4	2-3/4	CTC-1539053	150.78
	6E5973		P-UB-10	1-1/2	2-3/4	CTC-1361599	106.50
STEERING RH							
	6E5985		P-UB-10	1-1/2	2-3/4	CTC-1361599	106.50
TILT							
	6E5918		P-UB-10	2-1/4	4	CTC-1361171	101.36
	6E5966	Rod Bearing width- 0.98"	P-UB-10	2-1/2	4-3/4	CTC-1361131	143.18
	9T5778		P-UB-10	2-1/2	4-3/4	CTC-1358695	95.21
<b>MODEL 914</b>							
M.P. BUCKET TILT							
	4T4666		P-UB-10	2-1/2	4	CTC-7X2665	166.92
<b>MODEL 914G</b>							
STEERING							
	9T8823		I-O-3	1	2	CTC-9T0418	82.99

CATERPILLAR®



## REPLACEMENT KITS FOR CATERPILLAR® EQUIPMENT

Loaders - Wheel							
APPLICATION	CYL #	Misc-Parts, Instructions, etc.	CODE	ROD	BORE	KIT #	List \$
<b>MODEL 914G</b>							
TILT							
	6E5918		P-UB-10	2-1/4	4	CTC-1361171	101.36
<b>MODEL 916</b>							
BUCKET							
	3G7365		P-UB-10	1-1/2	3-1/2	CTC-7X2752	95.40
LIFT							
	4T8648		P-UB-10	2-1/4	4-1/4	CTC-7X2750	114.40
LIFT LH							
	3G6563		P-UB-10	2-1/4	4-1/4	CTC-7X2750	114.40
PIN PULLER							
	6E5393		I-O-3	1	2	CTC-9T0418	82.99
STEERING							
	1U3322		P-UB-10	1-1/2	3	CTC-7X2751	64.04
TILT							
	3G6571		P-UB-10	2-1/2	4-3/4	CTC-1328811	161.44
<b>MODEL 918F</b>							
LIFT							
	1342327		P-UB-10	2-1/4	4	CTC-1546526	150.74
	9T3937		P-UB-10	2-1/4	4	CTC-1546526	150.74
PIN PULLER							
	6E5393		I-O-3	1	2	CTC-9T0418	82.99
STEERING							
	9T2637		P-UB-10	1-1/2	2-3/4	CTC-1361599	106.50
TILT							
	1107845		P-UB-10	2-1/2	4-1/2	CTC-1113300	136.57
	1342671		P-UB-10	2-1/2	4-1/2	CTC-1113300	136.57
	6E4651		P-UB-10	2-1/2	4-1/2	CTC-1113300	136.57
<b>MODEL 920</b>							
BUCKET							
	7J6789		P-UB-10	2	4	CTC-7X2789	102.01
	8J5663		P-UB-10	2	4	CTC-7X2789	102.01
BUCKET LH							
	6J2806		P-UB-10	2	4	CTC-7X2789	102.01
BUCKET RH							
	6J2805		P-UB-10	2	4	CTC-7X2789	102.01
LIFT							
	3G5511		P-UB-10	2-1/4	4-1/4	CTC-7X2750	114.40
	3G5512		P-UB-10	2-1/4	4-1/4	CTC-7X2750	114.40
	6J8731		P-UB-10	2-1/4	4-1/4	CTC-7X2750	114.40
	6J8732		P-UB-10	2-1/4	4-1/4	CTC-7X2750	114.40
LIFT LH							
	7J9852		P-UB-10	2-1/4	4-1/4	CTC-7X2750	114.40
LIFT RH							
	7J9851		P-UB-10	2-1/4	4-1/4	CTC-7X2750	114.40
M.P. BUCKET LH							
	6J2806		P-UB-10	2	4	CTC-7X2789	102.01
M.P. BUCKET RH							
	6J2605		P-UB-10	2	4	CTC-7X2789	102.01
SIDE DUMP							
	8J5670		P-UB-10	2	4	CTC-7X2755	147.15
	8J5670		P-UB-10	2	4	CTC-7X7937	160.47
STEERING							
	6J5477		P-UB-10	1-1/2	3	CTC-7X2751	64.04
	7J9838		P-UB-10	1-1/2	3	CTC-1372530	90.31
	7J9838		P-UB-10	1-1/2	3	CTC-7X2751	64.04

CATERPILLAR®



## REPLACEMENT KITS FOR CATERPILLAR® EQUIPMENT

Loaders - Wheel							
APPLICATION	CYL #	Misc-Parts, Instructions, etc.	CODE	ROD	BORE	KIT #	List \$
<b>MODEL 920</b>							
TILT LH							
	3G5482		P-UB-10	2	4	CTC-1328816	92.75
	7J3052		P-UB-10	2	4	CTC-7X2789	102.01
	7J9676		P-UB-10	2	4	CTC-7X2789	102.01
TILT RH							
	3G5481		P-UB-10	2	4	CTC-1328816	92.75
	7J3051		P-UB-10	2	4	CTC-7X2789	102.01
	7J9675		P-UB-10	2	4	CTC-7X2789	102.01
<b>MODEL 924</b>							
M.P. BUCKET TILT							
	4T5545		P-UB-10	2-1/2	4-1/4	CTC-7X2663	49.39
<b>MODEL 924F</b>							
LIFT							
	1342327		P-UB-10	2-1/4	4	CTC-1546526	150.74
	9T3937		P-UB-10	2-1/4	4	CTC-1546526	150.74
STEERING							
	9T2637		P-UB-10	1-1/2	2-3/4	CTC-1361599	106.50
TILT							
	1107845		P-UB-10	2-1/2	4-1/2	CTC-1113300	136.57
	1342671		P-UB-10	2-1/2	4-1/2	CTC-1113300	136.57
	6E4651		P-UB-10	2-1/2	4-1/2	CTC-1113300	136.57
<b>MODEL 924G</b>							
COUPLER							
3PZ1-UP; 9SW1-UP; AAN1148-UP; DDA1-UP; EEB1-UP; RBB1-UP; WMB1-UP							
	1903085		I-U-10	1	2	CTC-1809872	117.91
9SW1-UP							
	1880563		I-U-10	1	2	CTC-1809872	117.91
9SW-UP; DDA1-UP							
	1783720		I-U-10	1	2	CTC-1809872	117.91
LIFT							
	1417483		P-UB-10	2-1/2	4	CTC-1542501	151.42
	9T8823		I-O-3	1	2	CTC-9T0418	82.99
3DZ1-UP; 6YW1-UP							
	1524187		P-UB-10	2-1/2	4-1/4	CTC-2341951	165.40
3PZ1-UP; 9SW1-UP; AAN1-UP; DDA1-UP; EEB1-UP; RBB1-UP; WMB1-UP							
	1417483		P-UB-10	2-1/2	4	CTC-1417483K	53.94
LOG FORK							
9SW1-UP							
	1491381		P-UB-10	2	3-1/2	CTC-2281778	77.70
MULTIPURPOSE BUCKET							
DDA1-UP; EEB1-UP; WMB1-UP							
	2681322		I-U-10	40 mm	3-1/2	CTC-2711529	24.94
STEERING							
	1426251		P-UB-10	1-1/2	2-3/4	CTC-1361599	106.50
3DZ1-UP; 3PZ1-UP; 6YW1-UP; 9SW1-UP; AAN1-UP; DDA1-UP; EEB1-UP; RBB1-UP; WMB1-UP							
	1426251		P-UB-10	1-1/2	2-3/4	CTC-2339204	62.57
3DZ1-UP; 3PZ1-UP; 6YW1-UP; 9SW1-UP; AAN1-UP; RBB1-UP; WMB1-UP							
	1426251		P-UB-10	1-1/2	2-3/4	CTC-2339204	62.57
TILT							
	1525306		P-UB-10	2-1/2	4-3/4	CTC-1361131	143.18
3DZ1-UP; 6YW1-UP							
	1525306		P-UB-10	2-1/2	4-3/4	CTC-2341948	90.62
3PZ1-UP; 9SW1-UP; AAN1-UP; DDA1-1987; RBB1-1046; WMB1-972							
	1417484		P-UB-10	2-1/2	5-1/4	CTC-1417484K	82.09
6YW1-UP							
	3408871		P-UB-10	2-1/2	4-3/4	CTC-3408871K	96.98

**CATERPILLAR®**



## REPLACEMENT KITS FOR CATERPILLAR® EQUIPMENT

Loaders - Wheel							
APPLICATION	CYL #	Misc-Parts, Instructions, etc.	CODE	ROD	BORE	KIT #	List \$
<b>MODEL 924G</b>							
TILT							
DDA1988-UP; EEB1-UP; RBB1-UP; WMB973-UP							
2689437			P-UB-10	2-1/2	5-1/4	CTC-2689437K	82.09
RBB1047-UP							
2689437			P-UB-10	2-1/2	5-1/4	CTC-2689437K	82.09
<b>MODEL 924Gz</b>							
LIFT							
AAB1-UP; DFZ1-UP; RTA1-UP; WGX1-UP							
1524187			P-UB-10	2-1/2	4-1/4	CTC-2341951	165.40
STEERING							
AAB1-UP; DFZ1-UP; RTA1-UP; WGX1-UP							
1426251			P-UB-10	1-1/2	2-3/4	CTC-2339204	62.57
TILT							
AAB1-UP; DFZ1-UP; RTA1-UP; WGX1-UP							
1525306			P-UB-10	2-1/2	4-3/4	CTC-2341948	90.62
DFZ1-UP							
3408871			P-UB-10	2-1/2	4-3/4	CTC-3408871K	96.98
<b>MODEL 924H</b>							
BUCKET							
KLN1-UP							
1809338			P-UB-10	2	4	CTC-2339205	53.31
BUCKET SIDE DUMP							
KLN1-UP							
1806336			P-U,UB-10	2	4	CTC-1807208	128.47
COUPLER							
HXC1-UP; JTM1-UP; KLN1-UP; LKW1-UP							
1903085			I-U-10	1	2	CTC-1809872	117.91
LIFT							
HXC1-UP; JTM1-UP; KLN1-UP; LKW1-UP							
1417483			P-UB-10	2-1/2	4	CTC-1417483K	53.94
MULTIPURPOSE BUCKET							
HXC1-UP; JTM1-UP; LKW1-UP							
2681322			I-U-10	40 mm	3-1/2	CTC-2711529	24.94
STEERING							
HXC1-UP; JTM1-UP; KLN1-UP; LKW1-UP							
1426251			P-UB-10	1-1/2	2-3/4	CTC-2339204	62.57
1426251			Bushing	1-3/4		CTC-4D4431	50.29
TILT							
HXC1-UP; JTM1-UP; KLN1-UP; LKW1-UP							
2689437			P-UB-10	2-1/2	5-1/4	CTC-2689437K	82.09
<b>MODEL 924Hz</b>							
LIFT							
JRL1-UP; JZZ1-UP; PED1-UP; WLB1-UP							
1524187			P-UB-10	2-1/2	4-1/4	CTC-2341951	165.40
STEERING							
JRL1-UP; JZZ1-UP; PED1-UP; WLB1-UP							
1426251			P-UB-10	1-1/2	2-3/4	CTC-2339204	62.57
TILT							
JRL1-UP; JZZ1-UP; WLB841-UP							
3408871			P-UB-10	2-1/2	4-3/4	CTC-3408871K	96.98
PED1-UP; WLB1-UP							
1525306			P-UB-10	2-1/2	4-3/4	CTC-2341948	90.62
<b>MODEL 926</b>							
BUCKET							
4T9387			P-UB-10	2	4	CTC-1328816	92.75

**CATERPILLAR®**



## REPLACEMENT KITS FOR CATERPILLAR® EQUIPMENT

Loaders - Wheel							
APPLICATION	CYL #	Misc-Parts, Instructions, etc.	CODE	ROD	BORE	KIT #	List \$
<b>MODEL 926</b>							
LIFT							
	3G2991		P-UB-10	2-1/2	4-3/4	CTC-1328811	161.44
	3G2991		P-UB-10	2-1/2	4-3/4	CTC-7X2660	179.61
PIN PULLER							
	6E5393		I-O-3	1	2	CTC-9T0418	82.99
STEERING							
	3G3501		P-UB-10	1-1/2	3	CTC-7X2751	64.04
TILT							
	3G2798		P-UB-10	2-1/2	5-1/2	CTC-7X2671	148.14
	3G2798		P-UB-10	2-1/2	5-1/2	CTC-9X2047	108.20
<b>MODEL 926E</b>							
BUCKET							
	4T9387		P-UB-10	2	4	CTC-1328816	92.75
LIFT							
	3G2991		P-UB-10	2-1/2	4-3/4	CTC-1328811	161.44
	3G2991		P-UB-10	2-1/2	4-3/4	CTC-7X2660	179.61
STEERING							
	3G3501		P-UB-10	1-1/2	3	CTC-7X2751	64.04
	4T1574		P-UB-10	2	4	CTC-1328816	92.75
TILT							
	3G2798		P-UB-10	2-1/2	5-1/2	CTC-7X2671	148.14
	3G2798		P-UB-10	2-1/2	5-1/2	CTC-9X2047	108.20
	4T1063		P-UB-10	2	4-1/4	CTC-7X2766	44.13
<b>MODEL 928F</b>							
LIFT							
	1341383		P-UB-10	2-1/2	4-1/2	CTC-1113300	136.57
	6E1400		P-UB-10	2-1/2	4-1/2	CTC-1113300	136.57
PIN PULLER							
	6E5393		I-O-3	1	2	CTC-9T0418	82.99
STEERING							
	9T6646		P-UB-10	1-1/2	2-3/4	CTC-1361599	106.50
TILT							
	1341382	Rod Bearing width- 0.98"	P-UB-10	2-1/2	4-3/4	CTC-1361131	143.18
	9T6645	Rod Bearing width- 0.98"	P-UB-10	2-1/2	4-3/4	CTC-1361131	143.18
<b>MODEL 928G</b>							
COUPLER							
	2370946		Chk Vlv Kit			CTC-2138433	12.48
LIFT							
	1191060	Rod Bearing width- 0.98"	P-UB-10	2-1/2	4-3/4	CTC-1864382	94.88
STEERING LH							
	1250374		P-UB-10	1-1/2	2-3/4	CTC-1856596	46.32
STEERING RH							
	1250373		P-UB-10	1-1/2	2-3/4	CTC-1856596	46.32
TILT							
	1188105		P-UB-10	2-1/2	5	CTC-2275347	93.84
<b>MODEL 928Hz</b>							
COUPLER							
BYD1-UP; CXX1-UP							
	1903085		I-U-10	1	2	CTC-1809872	117.91
CXX1-UP							
	2370946		Chk Vlv Kit			CTC-2138433	12.48
	2370946			2-1/2	5	CTC-2370946K	12.98
	3612508		I-U-10	1	2	CTC-1832091	11.59
	3612508		Chk Vlv Kit			CTC-2138433	12.48
LIFT							
BYD1-UP; CXX1-UP							
	1191060		P-UB-10	2-1/2	4-3/4	CTC-1864382	94.88



## REPLACEMENT KITS FOR CATERPILLAR® EQUIPMENT

Loaders - Wheel							
APPLICATION	CYL #	Misc-Parts, Instructions, etc.	CODE	ROD	BORE	KIT #	List \$
<b>MODEL 928Hz</b>							
STEERING							
BYD1-UP; CXK1-UP							
	1250373		P-UB-10	1-1/2	2-3/4	CTC-2339204	62.57
	1250374		P-UB-10	1-1/2	2-3/4	CTC-2339204	62.57
TILT							
BYD1-UP; CXK1-UP							
	1188105		P-UB-10	2-1/2	5	CTC-2275347	93.84
CXK867-UP							
	3408752		P-UB-10	2-1/2	5	CTC-3408752K	84.07
<b>MODEL 930</b>							
BUCKET							
	7J6789		P-UB-10	2	4	CTC-7X2789	102.01
	8J5663		P-UB-10	2	4	CTC-7X2789	102.01
BUCKET LH							
	6J2806		P-UB-10	2	4	CTC-7X2789	102.01
BUCKET RH							
	6J2805		P-UB-10	2	4	CTC-7X2789	102.01
LIFT							
	3G5471		P-UB-10	2-1/4	4-1/2	CTC-1326770	150.17
	4T0299		P-UB-10	2-1/4	4-1/2	CTC-7X2748	107.59
LIFT LH							
	7J9872		P-UB-10	2-1/4	4-1/2	CTC-7X2747	186.83
LIFT RH							
	7J9871		P-UB-10	2-1/4	4-1/2	CTC-7X2747	186.83
LOG FORK LH							
	8J5677		P-V-10	2	5	CTC-7X2763	135.46
LOG FORK RH							
	8J5676		P-V-10	2	5	CTC-7X2763	135.46
SIDE DUMP							
	8J5670		P-UB-10	2	4	CTC-7X2755	147.15
	8J5670		P-UB-10	2	4	CTC-7X7937	160.47
STEERING							
	7J9838		P-UB-10	1-1/2	3	CTC-1372530	90.31
	7J9838		P-UB-10	1-1/2	3	CTC-7X2751	64.04
TILT LH							
	7J9730		P-UB-10	2	4-1/4	CTC-7X2766	44.13
TILT RH							
	7J9729		P-UB-10	2	4-1/4	CTC-7X2766	44.13
<b>MODEL 930G</b>							
COUPLER							
TFW1-UP; TWR1-UP							
	1903085		I-U-10	1	2	CTC-1809872	117.91
LIFT							
TFW1-UP; TWR1-UP							
	2356823		P-UB-10	2-1/2	4-1/2	CTC-2356823K	55.85
MULTIPURPOSE BUCKET							
TFW1-UP; TWR1-UP							
	2681322		I-U-10	40 mm	3-1/2	CTC-2711529	24.94
TILT							
TFW1-UP; TWR1-UP							
	2356824		P-UB-10	2-3/4	6	CTC-2356824K	110.71
<b>MODEL 930H</b>							
COUPLER							
DHC1-UP; FTD1-UP							
	1903085		I-U-10	1	2	CTC-1809872	117.91

CATERPILLAR®





## REPLACEMENT KITS FOR CATERPILLAR® EQUIPMENT

Loaders - Wheel							
APPLICATION	CYL #	Misc-Parts, Instructions, etc.	CODE	ROD	BORE	KIT #	List \$
<b>MODEL 930H</b>							
LIFT							
		DHC1-UP; FTD1-UP					
	2356823		P-UB-10	2-1/2	4-1/2	CTC-2356823K	55.85
MULTIPURPOSE BUCKET							
		DHC1-UP; FTD1-UP					
	2681322		I-U-10	40 mm	3-1/2	CTC-2711529	24.94
STEERING							
		DHC1-UP; FTD1-UP					
	2379271		P-UB-10	1-1/2	2-3/4	CTC-2379271K	44.05
	2379271		Bushing	2		CTC-9M1328	68.24
TILT							
		DHC1-UP; FTD1-UP					
	2356824		P-UB-10	2-3/4	6	CTC-2356824K	110.71
<b>MODEL 930R, 930T</b>							
ARTICULATION							
	9T2447	930R only	P-UB-10	1-3/4	3	CTC-7X2825	53.69
LIFT LH							
	7J9872		P-UB-10	2-1/4	4-1/2	CTC-7X2747	186.83
LIFT RH							
	7J9871		P-UB-10	2-1/4	4-1/2	CTC-7X2747	186.83
STEERING							
	7J9838		P-UB-10	1-1/2	3	CTC-1372530	90.31
	7J9838		P-UB-10	1-1/2	3	CTC-7X2751	64.04
TILT LH							
	7J9730		P-UB-10	2	4-1/4	CTC-7X2766	44.13
TILT RH							
	7J9729		P-UB-10	2	4-1/4	CTC-7X2766	44.13
<b>MODEL 936</b>							
LIFT							
	3G2991		P-UB-10	2-1/2	4-3/4	CTC-7X2660	179.61
	4T1674		P-UB-10	2-1/2	5-1/2	CTC-7X2672	88.77
	9T1196		P-UB-10	2-1/2	5-1/2	CTC-7X2672	88.77
PIN COUPLER							
	4T9981		I-O-3	1	2	CTC-9T0418	82.99
	6E5392		I-O-3	1	2	CTC-9T0418	82.99
	6E5393		I-O-3	1	2	CTC-9T0418	82.99
	9T8485		I-O-3	1	2	CTC-9T0418	82.99
STEERING							
	3G5110		P-UB-10	1-3/4	3-1/2	CTC-7X2784	56.35
TILT							
	3G5291		P-UB-10	2-3/4	6-1/2	CTC-7X2686	120.72
<b>MODEL 936E</b>							
LIFT							
	3G2991		P-UB-10	2-1/2	4-3/4	CTC-7X2660	179.61
	4T0263		P-UB-10	2-1/2	4-3/4	CTC-7X2660	179.61
	4T0263		P-UB-10	2-1/2	4-3/4	CTC-7X2673	178.40
	4T1674		P-UB-10	2-1/2	5-1/2	CTC-7X2672	88.77
	9T1196		P-UB-10	2-1/2	5-1/2	CTC-7X2672	88.77
M.P. BUCKET							
	4T9387		P-UB-10	2	4	CTC-7X2789	102.01
M.P. BUCKET TILT							
	4T5545		P-UB-10	2-1/2	4-1/4	CTC-7X2663	49.39
PIN COUPLER							
	4T9981		I-O-3	1	2	CTC-9T0418	82.99
	9T2352		I-O-3	1	2	CTC-9T0418	82.99
	9T8485		I-O-3	1	2	CTC-9T0418	82.99

**CATERPILLAR®**



## REPLACEMENT KITS FOR CATERPILLAR® EQUIPMENT

Loaders - Wheel							
APPLICATION	CYL #	Misc-Parts, Instructions, etc.	CODE	ROD	BORE	KIT #	List \$
<b>MODEL 936E</b>							
STEERING							
	3G3501		P-UB-10	1-1/2	3	CTC-7X2751	64.04
	3G5110		P-UB-10	1-3/4	3-1/2	CTC-7X2784	56.35
TILT							
	3G5291		P-UB-10	2-3/4	6-1/2	CTC-7X2686	120.72
<b>MODEL 936F</b>							
LIFT							
	9T1196		P-UB-10	2-1/2	5-1/2	CTC-7X2672	88.77
PIN PULLER							
	6E5393		I-O-3	1	2	CTC-9T0418	82.99
STEERING							
	3G5110		P-UB-10	1-3/4	3-1/2	CTC-7X2784	56.35
	6E2035		P-UB-10	1-3/4	3-1/2	CTC-7X2784	56.35
TILT							
	3G5291		P-UB-10	2-3/4	6-1/2	CTC-7X2686	120.72
<b>MODEL 938F</b>							
LIFT							
	1287678		P-UB-10	2-1/2	5	CTC-1361967	193.76
	9T7160	Rod Bearing width- 0.98"	P-UB-10	2-1/2	4-3/4	CTC-1361131	143.18
STEERING							
	1050094		P-UB-10	1-3/4	3	CTC-7X2825	53.69
TILT							
	1377855		P-UB-10	2-3/4	5-1/2	CTC-1358736	212.05
	9T7161		P-UB-10	2-3/4	5-1/2	CTC-1358736	212.05
<b>MODEL 938G</b>							
COUPLER							
	2080828		Chk Vlv Kit			CTC-2138433	12.48
	2370946		Chk Vlv Kit			CTC-2138433	12.48
LIFT							
	1KM1-1123; 2RM1-1123; 7SN1-384						
	9T7160	Head# 1206679	P-UB-10	2-1/2	4-3/4	CTC-1864382	94.88
	9T7160	Head# 9T3609	P-UB-10	2-1/2	4-3/4	CTC-9X2151	83.05
	1KM1124-; 2RM1124-; 7SN385-						
	1287678		P-UB-10	2-1/2	5	CTC-1361967	193.76
STEERING							
	1050094		P-UB-10	1-3/4	3	CTC-7X2825	53.69
	1393312		P-UB-10	1-3/4	3	CTC-7X2825	53.69
TILT							
	4YS1-						
	1377855		P-UB-10	2-3/4	5-1/2	CTC-1358736	212.05
	9T7161		P-UB-10	2-3/4	5-1/2	CTC-1358736	212.05
<b>MODEL 938H</b>							
COUPLER							
	JKM1-UP; MJC1-UP						
	2370946		Chk Vlv Kit			CTC-2138433	12.48
LIFT							
	JKM1-UP; LKM1-UP; MCC1-UP; MJC1-UP						
	2549037		P-UB-10	70 mm	130 mm	CTC-2549037K	372.34
STEERING							
	JKM1-153; LKM1-175						
	1393312		P-UB-10	1-3/4	3	CTC-2275350	33.45
	JKM154-UP; LKM176-UP; MCC1-UP; MJC1-UP						
	3149340		P-UB-10	1-3/4	3	CTC-3260504	68.83
TILT							
	JKM1-905; LKM1-1037; MCC1-UP; MJC1-835						
	3388416		P-UB-10	70 mm	140 mm	CTC-3388416K	349.71

CATERPILLAR®



## REPLACEMENT KITS FOR CATERPILLAR® EQUIPMENT

Loaders - Wheel							
APPLICATION	CYL #	Misc-Parts, Instructions, etc.	CODE	ROD	BORE	KIT #	List \$
<b>MODEL 938H</b>							
TILT							
JKM1-988; LKM1-1037; MJC1-810							
	3171090	High Lift Arrangement	P-UB-10	70 mm	140 mm	CTC-3171090K	349.71
JKM906-UP; LKM1038-UP; MJC836-UP							
	3461093		P-UB-10	70 mm	140 mm	CTC-3461093K	349.71
JKM989-UP; LKM1038-UP; MJC811-UP							
	3461094	High Lift Arrangement	P-UB-10	70 mm	140 mm	CTC-3461094K	349.71
<b>MODEL 944, 944A</b>							
LOG FORK LH							
	8J5677		P-V-10	2	5	CTC-7X2763	135.46
LOG FORK RH							
	8J5676		P-V-10	2	5	CTC-7X2763	135.46
<b>MODEL 950</b>							
LIFT							
	7J9690		P-UB-10	2-1/2	5-1/2	CTC-9X2050	100.69
LIFT LH							
	1U1147		P-UB-10	3	6	CTC-7X2698	186.32
LIFT RH							
	1U1148		P-UB-10	3	6	CTC-7X2698	186.32
LOG FORK LH							
	8J5677		P-V-10	2	5	CTC-7X2763	135.46
LOG FORK RH							
	8J5676		P-V-10	2	5	CTC-7X2763	135.46
SIDE DUMP							
	8J5690		P-V-10	2	5	CTC-7X2763	135.46
STEERING							
	3G0892		P-UB-10	1-3/4	3-1/2	CTC-7X2762	100.06
	3G0892		P-UB-10	1-3/4	3-1/2	CTC-7X2784	56.35
	7J9685		P-UB-10	1-1/2	3-1/2	CTC-7X2812	104.03
TILT							
	3G8786		P-UB-10	3-1/4	7	CTC-7X2704	141.41
	7J9695		P-UB-10	2-1/2	5-1/2	CTC-9X2050	100.69
TILT LH							
	7J9696		P-UB-10	2-1/2	5-1/2	CTC-9X2050	100.69
TILT RH							
	7J9363		P-UB-10	2-1/2	6	CTC-1363121	164.51
TREE HARVESTER DELIMBER							
	8J3829		P-UB-10	2	4	CTC-7X2789	102.01
	9J2481		P-UB-10	1-3/4	3	CTC-7X2791	88.60
<b>MODEL 950B, 950E, 950F</b>							
LIFT							
	4T0263	950B & 950E only	P-UB-10	2-1/2	4-3/4	CTC-1328811	161.44
	4T0263		P-UB-10	2-1/2	4-3/4	CTC-7X2660	179.61
	4T0263		P-UB-10	2-1/2	4-3/4	CTC-7X2673	178.40
	7J9902	950F only	P-UB-10	2	4-1/4	CTC-7X2819	105.12
LIFT LH							
	1U1147		P-UB-10	3	6	CTC-7X2698	186.32
LIFT RH							
	1U1148		P-UB-10	3	6	CTC-7X2698	186.32
STEERING							
	3G0892		P-UB-10	1-3/4	3-1/2	CTC-7X2784	56.35
	6E3889		P-UB-10	1-3/4	3-1/2	CTC-7X2784	56.35
	6E4892		P-UB-10	1-3/4	3-1/2	CTC-7X2784	56.35
	6E5024	950B & 950F only	P-UB-10	2	4	CTC-1113302	118.96
TILT							
	3G8786		P-UB-10	3-1/4	7	CTC-1328518	229.26



## REPLACEMENT KITS FOR CATERPILLAR® EQUIPMENT

Loaders - Wheel							
APPLICATION	CYL #	Misc-Parts, Instructions, etc.	CODE	ROD	BORE	KIT #	List \$
<b>MODEL 950G</b>							
COUPLER							
	2080828		Chk Vlv Kit			CTC-2138433	12.48
	2370946		Chk Vlv Kit			CTC-2138433	12.48
LIFT							
	1188296		P-UB-10	3	6	CTC-7X2698	186.32
	1250024		P-UB-10	3	6	CTC-7X2698	186.32
STEERING							
	1188288	Head# 1537182	P-UB-10	1-3/4	3-1/2	CTC-2281795	98.14
	1630324	Head# 1630329	P-UB-10	1-3/4	3-1/2	CTC-2281795	98.14
	4BS1-413; 3JW1-684; 5FW1-784						
	1188288	Head# 9T7890	P-UB-10	1-3/4	3-1/2	CTC-7X2784	56.35
TILT							
	1189001		P-UB-10	3-1/4	7	CTC-7X2710	203.20
	1518206		P-UB-10	3-1/4	8-1/2	CTC-1518206K	349.71
<b>MODEL 950H</b>							
COUPLER							
	2370946		Chk Vlv Kit			CTC-2138433	12.48
LIFT							
	2424271		P-UB-10	3-1/4	5-3/4	CTC-2424271K	253.39
	2424272		P-UB-10	3-1/4	5-3/4	CTC-2424272K	253.39
STEERING							
	1630324		P-UB-10	1-3/4	3-1/2	CTC-2281795	98.14
TILT							
	2424270		P-UB-10	3-1/4	6-1/4	CTC-2424270K	210.06
	2457487		P-UB-10	3-1/2	7-1/2	CTC-2457487K	258.38
	2457491		P-UB-10	3-1/4	6-1/4	CTC-2457491K	210.06
<b>MODEL 960F</b>							
LIFT							
	7J9902		P-UB-10	2	4-1/4	CTC-7X2819	105.12
LIFT LH							
	1U1147		P-UB-10	3	6	CTC-7X2698	186.32
LIFT RH							
	1U1148		P-UB-10	3	6	CTC-7X2698	186.32
STEERING							
	3G0892		P-UB-10	1-3/4	3-1/2	CTC-7X2784	56.35
	6E3889		P-UB-10	1-3/4	3-1/2	CTC-7X2784	56.35
	6E4892		P-UB-10	1-3/4	3-1/2	CTC-7X2784	56.35
TILT							
	3G8786		P-UB-10	3-1/4	7	CTC-1328518	229.26
<b>MODEL 960G, 962G</b>							
LIFT RH							
	1188296		P-UB-10	3	6	CTC-7X2698	186.32
	1250024		P-UB-10	3	6	CTC-7X2698	186.32
STEERING							
	1188288		P-UB-10	1-3/4	3-1/2	CTC-7X2784	56.35
TILT							
	1294447		P-UB-10	3-1/4	7	CTC-7X2710	203.20
<b>MODEL 966</b>							
LIFT							
	9J2434		P-UB-10	2-1/2	6-1/2	CTC-7X2666	169.85
STEERING							
	6E5024		P-UB-10	2	4	CTC-1113302	118.96
STEERING LH							
	7J9356		P-UB-10	2	4	CTC-7X2755	147.15
TILT							
	3G5497		P-UB-14	3-1/4	8-1/4	CTC-7X2703	235.71

CATERPILLAR®



## REPLACEMENT KITS FOR CATERPILLAR® EQUIPMENT

Loaders - Wheel							
APPLICATION	CYL #	Misc-Parts, Instructions, etc.	CODE	ROD	BORE	KIT #	List \$
<b>MODEL 966</b>							
TILT LH							
	7J9364		P-UB-10	2-1/2	6	CTC-7X2669	233.76
<b>MODEL 966A</b>							
LOG FORK LH							
	8J5677		P-V-10	2	5	CTC-7X2763	135.46
LOG FORK RH							
	8J5676		P-V-10	2	5	CTC-7X2763	135.46
SIDE DUMP							
	8J5733		P-V-10	2	5	CTC-7X2763	135.46
TILT LH							
	6J6874		P-UB-10	2-1/2	6	CTC-7X2669	233.76
	7J9364		P-UB-10	2-1/2	6	CTC-7X2669	233.76
	7J9364		P-UB-10	2-1/2	6	CTC-8T2066	105.74
TILT RH							
	6J6873		P-UB-10	2-1/2	6	CTC-7X2669	233.76
	7J9363		P-UB-10	2-1/2	6	CTC-7X2669	233.76
	7J9363		P-UB-10	2-1/2	6	CTC-8T2066	105.74
<b>MODEL 966B</b>							
LIFT							
	9J2434		P-UB-10	2-1/2	6-1/2	CTC-7X2666	169.85
LIFT RH							
	4J7859		P-UB-10	2	4	CTC-7X2755	147.15
LOG FORK							
	8J5755		P-UB-10	2-1/4	5	CTC-7X2729	162.34
LOG FORK LH							
	8J5677		P-V-10	2	5	CTC-7X2763	135.46
LOG FORK RH							
	8J5676		P-V-10	2	5	CTC-7X2763	135.46
SIDE DUMP							
	8J5733		P-V-10	2	5	CTC-7X2763	135.46
SPECIAL APPLICATION							
	4J9996		P-UB-10	2-1/2	7-1/4	CTC-7X2661	180.93
STEERING LH							
	7J9356		P-UB-10	2	4	CTC-7X2755	147.15
STEERING RH							
	7J9355		P-UB-10	2	4	CTC-7X2755	147.15
TILT LH							
	6J6874		P-UB-10	2-1/2	6	CTC-7X2669	233.76
	7J9364		P-UB-10	2-1/2	6	CTC-7X2669	233.76
	7J9364		P-UB-10	2-1/2	6	CTC-8T2066	105.74
TILT RH							
	6J6873		P-UB-10	2-1/2	6	CTC-7X2669	233.76
	7J9363		P-UB-10	2-1/2	6	CTC-7X2669	233.76
	7J9363		P-UB-10	2-1/2	6	CTC-8T2066	105.74
<b>MODEL 966C</b>							
BUCKET TILT LH							
	5J2464		P-UB-10	2-1/2	6	CTC-8T2066	105.74
BUCKET TILT RH							
	5J2463		P-UB-10	2-1/2	6	CTC-8T2066	105.74
LIFT							
	3G5471		P-UB-10	2-1/4	4-1/2	CTC-1326770	150.17
	9J2434		P-UB-10	2-1/2	6-1/2	CTC-7X2666	169.85
LOG FORK							
	8J5755		P-UB-10	2-1/4	5	CTC-7X2729	162.34
LOG FORK LH							
	4K0502		P-V-10	2	5	CTC-7X2763	135.46
	8J5677		P-V-10	2	5	CTC-7X2763	135.46

CATERPILLAR®



## REPLACEMENT KITS FOR CATERPILLAR® EQUIPMENT

Loaders - Wheel							
APPLICATION	CYL #	Misc-Parts, Instructions, etc.	CODE	ROD	BORE	KIT #	List \$
<b>MODEL 966C</b>							
LOG FORK RH							
	8J5676		P-V-10	2	5	CTC-7X2763	135.46
SIDE DUMP							
	8J5733		P-V-10	2	5	CTC-7X2763	135.46
SPECIAL APPLICATION							
	4J9996		P-UB-10	2-1/2	7-1/4	CTC-7X2661	180.93
STEERING LH							
	7J9356		P-UB-10	2	4	CTC-7X2755	147.15
STEERING RH							
	7J9355		P-UB-10	2	4	CTC-7X2755	147.15
TILT LH							
	6J6874		P-UB-10	2-1/2	6	CTC-7X2669	233.76
	7J9364		P-UB-10	2-1/2	6	CTC-7X2669	233.76
	7J9364		P-UB-10	2-1/2	6	CTC-8T2066	105.74
TILT RH							
	6J6873		P-UB-10	2-1/2	6	CTC-7X2669	233.76
	6J6873		P-UB-10	2-1/2	6	CTC-8T2066	105.74
	6J6875		P-UB-10	2-1/2	6	CTC-8T2066	105.74
	6J6876		P-UB-10	2-1/2	6	CTC-8T2066	105.74
	7J9363		P-UB-10	2-1/2	6	CTC-1363121	164.51
	7J9363		P-UB-10	2-1/2	6	CTC-7X2669	233.76
<b>MODEL 966D</b>							
LIFT LH							
	3G5495		P-UB-10	3-1/4	7	CTC-7X2710	203.20
LIFT RH							
	3G5496		P-UB-10	3-1/4	7	CTC-7X2710	203.20
STEERING							
	4T1574		P-UB-10	2	4	CTC-1328816	92.75
	6E4892		P-UB-10	1-3/4	3-1/2	CTC-7X2784	56.35
	6E5024		P-UB-10	2	4	CTC-1113302	118.96
	9J7061		P-UB-10	2	4	CTC-7X2789	102.01
TILT							
	3G5497		P-UB-14	3-1/4	8-1/4	CTC-7X2703	235.71
<b>MODEL 966E, 966F</b>							
LIFT LH							
	3G5495		P-UB-10	3-1/4	7	CTC-7X2710	203.20
LIFT RH							
	3G5496		P-UB-10	3-1/4	7	CTC-7X2710	203.20
STEERING							
	4T1574		P-UB-10	2	4	CTC-1328816	92.75
	6E5024		P-UB-10	2	4	CTC-1113302	118.96
	9J7061	966E only	P-UB-10	2	4	CTC-7X2789	102.01
TILT							
	3G5497		P-UB-14	3-1/4	8-1/4	CTC-7X2703	235.71
<b>MODEL 966G</b>							
LIFT LH							
	1332964		P-UB-10	3-1/4	7	CTC-7X2710	203.20
LIFT RH							
	1332963		P-UB-10	3-1/4	7	CTC-7X2710	203.20
STEERING							
	1331747		P-UB-10	2	3-1/2	CTC-7X2783	102.97
TILT							
	1332962		P-UB-10	3-1/4	9-1/4	CTC-1332962K	286.29
	1449005		P-UB-10	3-1/4	8-1/4	CTC-2281780	236.62
	1713953		P-UB-10	3-1/4	8-1/4	CTC-2281780	236.62
	1882445		P-UB-10	3-1/2	9-1/4	CTC-2282533	314.92

CATERPILLAR®



## REPLACEMENT KITS FOR CATERPILLAR® EQUIPMENT

Loaders - Wheel							
APPLICATION	CYL #	Misc-Parts, Instructions, etc.	CODE	ROD	BORE	KIT #	List \$
<b>MODEL 966H</b>							
LIFT							
	2424274		P-UB-10	3-1/2	6-1/4	CTC-2959888	206.33
	2424275		P-UB-10	3-1/2	6-1/4	CTC-2959888	206.33
STEERING							
	1331747		P-UB-10	2	3-1/2	CTC-7X2783	102.97
TILT							
	2424273		P-UB-10	3-1/4	170 mm	CTC-2424273K	218.79
	2448777		P-UB-10	3-3/4	7-3/4	CTC-2448777K	252.44
	2457484		P-UB-10	3-1/4	170 mm	CTC-2457484K	218.79
<b>MODEL 966R</b>							
LIFT							
	9J2434		P-UB-10	2-1/2	6-1/2	CTC-7X2666	169.85
STEERING LH							
	7J9356		P-UB-10	2	4	CTC-7X2755	147.15
STEERING RH							
	7J9355		P-UB-10	2	4	CTC-7X2755	147.15
TILT LH							
	7J9364		P-UB-10	2-1/2	6	CTC-1363121	164.51
	7J9364		P-UB-10	2-1/2	6	CTC-7X2669	233.76
	7J9364		P-UB-10	2-1/2	6	CTC-8T2066	105.74
TILT RH							
	7J9363		P-UB-10	2-1/2	6	CTC-1363121	164.51
	7J9363		P-UB-10	2-1/2	6	CTC-7X2669	233.76
	7J9363		P-UB-10	2-1/2	6	CTC-8T2066	105.74
<b>MODEL 970F</b>							
LIFT LH							
	6E5879		P-UB-10	3-1/4	7	CTC-7X2710	203.20
LIFT RH							
	6E5878		P-UB-10	3-1/4	7	CTC-7X2710	203.20
STEERING							
	4T1574		P-UB-10	2	4	CTC-1328816	92.75
	6E5024		P-UB-10	2	4	CTC-1113302	118.96
TILT							
	3G5497		P-UB-14	3-1/4	8-1/4	CTC-7X2703	235.71
<b>MODEL 972G</b>							
LIFT LH							
	1332964	Piston Bearings; 1.49", 1.99"	P-UB-10	3-1/4	7	CTC-7X2710	203.20
	1EW1-UP; 4WW1-UP; 6AW1-UP; 7LS1-UP; 9GW1-500; AAW1-400						
	1332964	Piston Bearing; 1.49"	P-UB-10	3-1/4	7	CTC-2281779	150.19
LIFT RH							
	1332963	Piston Bearings; 1.49", 1.99"	P-UB-10	3-1/4	7	CTC-7X2710	203.20
	1EW1-UP; 4WW1-UP; 6AW1-UP; 7LS1-UP; 9GW1-500; AAW1-400						
	1332963	Piston Bearing; 1.49"	P-UB-10	3-1/4	7	CTC-2281779	150.19
STEERING							
	1331747		P-UB-10	2	3-1/2	CTC-7X2783	102.97
	1EW1-UP; 4WW1-UP; 6AW1-UP; 7LS1-UP; 9GW1-319; AAW1-215						
	1331747		P-UB-10	2	3-1/2	CTC-7X2783	102.97
	1EW1-UP; 6AW1-UP						
	1331747		P-UB-1	2		CTC-8C4510	31.80
TILT							
	1EW1-UP; 4WW1-341; 6AW1-UP; 7SL1-306; 9GW1-292; AAW1-200						
	1332962		P-UB-10	3-1/4	9-1/4	CTC-1332962K	286.29
	1EW1-UP; 4WW342-UP; 6AW1-UP; 9GW293-UP; AAW201-UP						
	1882445		P-UB-10	3-1/2	9-1/4	CTC-1882445K	247.28
	1EW1-UP; 6AW1-UP						
	1744715		P-UB-10	3-1/4	9-1/4	CTC-1744715K	202.63
	1905955	High Lift Arrangement	P-UB-10	3-1/2	9-1/4	CTC-1905955K	247.28





## REPLACEMENT KITS FOR CATERPILLAR® EQUIPMENT

Loaders - Wheel							
APPLICATION	CYL #	Misc-Parts, Instructions, etc.	CODE	ROD	BORE	KIT #	List \$
<b>MODEL 972G</b>							
TILT							
4WW1-UP; 7SL1-UP							
1533747		Logging Arrangement	P-UB-10	2-1/4	5	CTC-2417578	63.66
2032208		Logging Arrangement	P-UB-10	2-1/4	5	CTC-2417578	63.66
AAW1-196							
1449005			P-UB-10	3-1/4	8-1/4	CTC-1449005K	174.90
<b>MODEL 972H</b>							
BUCKET							
A7D1-UP							
2200525			I-U-15	70 mm	125 mm	CTC-3704117	407.17
COUPLER							
A7D1-UP							
2370946			Chk Vlv Kit			CTC-2138433	12.48
2370946				2-1/2	5	CTC-2370946K	12.98
3612507			Chk Vlv Kit			CTC-2138433	12.48
3612507			I-U-10	1	2-1/2	CTC-3156338	17.82
3612508			I-U-10	1	2	CTC-1832091	11.59
3612508			Chk Vlv Kit			CTC-2138433	12.48
LIFT							
A7D1-UP; A7G1-UP; A7J1-UP; GTA1-UP; WLA1-UP							
2424274			P-UB-10	3-1/2	6-1/4	CTC-2959888	206.33
2424275			P-UB-10	3-1/2	6-1/4	CTC-2959888	206.33
STEERING							
A7D1-595; A7G1-1005; A7J1-295; WLA1-UP							
1331747			P-UB-10	2	3-1/2	CTC-7X2783	102.97
A7D596-UP; A7G1006-UP; A7J296-UP; GTA1-UP; WLA1-UP							
3149336			P-UB-10	2	3-1/2	CTC-3260502	139.24
TILT							
A7D1-UP							
2032208		Logging Arrangement	P-UB-10	2-1/4	5	CTC-2417578	63.66
A7D1-UP; A7G1-2157; A7J1-UP; GTA1-UP; WLA1-UP							
2448777		Logging Arrangement	P-UB-10	3-3/4	7-3/4	CTC-3652880	185.91
A7D1-UP; A7G1-UP; A7J1-UP; GTA1-UP							
2457486		High Lift Arrangement	P-UB-10	3-3/4	7-3/4	CTC-3652880	185.91
A7D1-UP; A7G1-UP; GTA1-UP							
3585190		High Lift Arrangement	P-UB-10	3-3/4	7-3/4	CTC-3652880	185.91
A7D1-UP; A7G2158-UP; GTA1-UP; WLA1-UP							
3562220			P-UB-10	3-3/4	7-3/4	CTC-3652880	185.91
<b>MODEL 980, 980B</b>							
LIFT							
7J9818		980B only	P-V-10	2-1/2	6-1/2	CTC-7X2678	109.43
7J9818			P-UB-10	3	7-1/4	CTC-7X2699	215.29
LOG FORK							
8J5767			P-UB-10	2-1/4	5	CTC-7X2729	162.34
STEERING LH							
7J9786			P-UB-10	2-1/4	4-1/2	CTC-7X2747	186.83
STEERING RH							
7J9785			P-UB-10	2-1/4	4-1/2	CTC-7X2747	186.83
TILT LH							
7J9742			P-UB-10	2-1/2	5-1/2	CTC-9X2050	100.69
TILT RH							
7J9741			P-UB-10	2-1/2	5-1/2	CTC-9X2050	100.69
<b>MODEL 980C</b>							
LIFT							
9J5559			P-UB-10	3-1/2	7-1/2	CTC-7X2730	160.02
9J8002			P-UB-10	2-3/4	5-1/2	CTC-7X2684	153.57

**CATERPILLAR®**



## REPLACEMENT KITS FOR CATERPILLAR® EQUIPMENT

Loaders - Wheel							
APPLICATION	CYL #	Misc-Parts, Instructions, etc.	CODE	ROD	BORE	KIT #	List \$
<b>MODEL 980C</b>							
LIFT-DEEPER DIG							
	1U3527		P-UB-10	3-1/2	7-1/2	CTC-7X2730	160.02
LIFT-HIGH							
	4T6791		P-UB-10	3	6-1/4	CTC-7X2701	112.69
	4T7949		P-UB-10	3	6-1/4	CTC-7X2701	112.69
LOGGER TILT							
	3G5069		P-UB-10	2-3/4	7	CTC-7X2691	146.58
	3G5070		P-UB-10	2-3/4	7	CTC-7X2691	146.58
STEERING							
	6E6653		P-UB-10	2-1/4	4-1/2	CTC-1354392	140.37
STEERING LH							
	9J6536		P-UB-10	2-1/4	4-1/2	CTC-1373529	62.58
STEERING RH							
	9J5869		P-UB-10	2-1/4	4-1/2	CTC-1373529	62.58
TILT							
	1U0418		P-UB-10	3	5-1/2	CTC-7X2813	227.02
	9T2418		P-UB-10	3	6-1/4	CTC-7X2701	112.69
	9T2419		P-UB-10	3	6-1/4	CTC-7X2701	112.69
TILT LH							
	3G1306		P-UB-10	2-3/4	6-1/4	CTC-7X2688	147.96
	3G5070		P-UB-10	2-3/4	7	CTC-1328284	133.09
	4T6791		P-UB-10	3	6-1/4	CTC-7X2701	112.69
	9T2419		P-UB-10	3	6-1/4	CTC-1328491	260.49
TILT RH							
	3G1305		P-UB-10	2-3/4	6-1/4	CTC-7X2688	147.96
	3G5069		P-UB-10	2-3/4	7	CTC-1328284	133.09
	4T7949		P-UB-10	3	6-1/4	CTC-7X2701	112.69
	6E4866		P-UB-10	2-3/4	6-1/4	CTC-7X2688	147.96
	9T2418		P-UB-10	3	6-1/4	CTC-1328491	260.49
<b>MODEL 980F</b>							
LIFT							
	1U3527		P-UB-10	3-1/2	7-1/2	CTC-7X2730	160.02
STEERING							
	6E6653		P-UB-10	2-1/4	4-1/2	CTC-1354392	140.37
STEERING LH							
	9J6536		P-UB-10	2-1/4	4-1/2	CTC-1373529	62.58
STEERING RH							
	9J5869		P-UB-10	2-1/4	4-1/2	CTC-1373529	62.58
TILT LH							
	3G1306		P-UB-10	2-3/4	6-1/4	CTC-7X2688	147.96
	3G5070		P-UB-10	2-3/4	7	CTC-1328284	133.09
	4T6791		P-UB-10	3	6-1/4	CTC-7X2701	112.69
	9T2419		P-UB-10	3	6-1/4	CTC-1328491	260.49
TILT RH							
	3G1305		P-UB-10	2-3/4	6-1/4	CTC-7X2688	147.96
	3G5069		P-UB-10	2-3/4	7	CTC-1328284	133.09
	4T7949		P-UB-10	3	6-1/4	CTC-7X2701	112.69
	6E4866		P-UB-10	2-3/4	6-1/4	CTC-7X2688	147.96
	9T2418		P-UB-10	3	6-1/4	CTC-1328491	260.49
<b>MODEL 980G</b>							
LIFT							
	1118181		P-UB-10	3-1/2	7-3/4	CTC-2281775	159.53
STEERING							
	1151371		P-UB-10	2-1/4	4	CTC-1546526	150.74
TILT							
	1463032		P-UB-10	3	7	CTC-1605796	303.16

CATERPILLAR®



## REPLACEMENT KITS FOR CATERPILLAR® EQUIPMENT

Loaders - Wheel							
APPLICATION	CYL #	Misc-Parts, Instructions, etc.	CODE	ROD	BORE	KIT #	List \$
<b>MODEL 980G</b>							
TILT LH							
	1125004		P-UB-10	2-3/4	6-1/4	CTC-7X2688	147.96
	1240617		P-UB-10	3	7	CTC-1605796	303.16
	1246227		P-UB-10	3	6-1/4	CTC-1917694	217.44
	1463035		P-UB-10	3	7	CTC-1605796	303.16
TILT RH							
	1125003		P-UB-10	2-3/4	6-1/4	CTC-7X2688	147.96
	1240616		P-UB-10	3	7	CTC-1605796	303.16
	1246228		P-UB-10	3	6-1/4	CTC-1917694	217.44
<b>MODEL 980H</b>							
LIFT							
	1118181		P-UB-10	3-1/2	7-3/4	CTC-2281775	159.53
STEERING							
	1151371		P-UB-10	2-1/4	4	CTC-1546526	150.74
TILT LH							
	1125004		P-UB-10	2-3/4	6-1/4	CTC-7X2688	147.96
	1240617		P-UB-10	3	7	CTC-1605796	303.16
	1246227		P-UB-10	3	6-1/4	CTC-1917694	217.44
TILT RH							
	1125003		P-UB-10	2-3/4	6-1/4	CTC-7X2688	147.96
	1240616		P-UB-10	3	7	CTC-1605796	303.16
	1246228		P-UB-10	3	6-1/4	CTC-1917694	217.44
<b>MODEL 988</b>							
LIFT							
	4J7377		P-UB-10	3-1/4	8-1/4	CTC-7X2715	264.94
	7J9744		P-UB-10	3-1/4	8-1/4	CTC-7X2717	204.21
	9J4893		P-UB-10	3-1/4	8-1/4	CTC-7X2717	204.21
STEERING							
	6J7590		P-UB-10	2-1/4	5	CTC-7X2729	162.34
	7J9718		P-UB-10	2-1/4	5	CTC-7X2729	162.34
	7J9984		P-UB-10	2-1/4	5	CTC-7X2729	162.34
TILT							
	9J3632		P-UB-10	3-1/4	7-3/4	CTC-7X2706	266.70
TILT LH							
	4J5744		P-UB-10	2-1/2	6-1/2	CTC-8T1376	79.55
	7J9762		P-UB-10	2-3/4	6-1/2	CTC-7X2689	161.01
TILT RH							
	4J5743		P-UB-10	2-1/2	6-1/2	CTC-8T1376	79.55
	7J9761		P-UB-10	2-3/4	6-1/2	CTC-7X2689	161.01
UNSPECIFIED APPLICATION							
	7K9401		P-UB-10	2-1/4	5	CTC-7X2729	162.34
<b>MODEL 988B</b>							
BUCKET LIFT							
	9T8257		P-UB-10	4	8-1/2	CTC-7X2742	216.18
LIFT							
	1U4679		P-UB-10	4	8-1/2	CTC-7X2734	302.92
	4T7585		P-UB-10	4	8-1/2	CTC-7X2742	216.18
	8J5779		P-UB-10	4	8-1/2	CTC-7X2734	302.92
	9T8257		P-UB-10	4	8-1/2	CTC-7X2742	216.18
LOGGER TILT							
	3G2976		P-UB-10	3-1/2	8-1/2	CTC-7X2719	187.84
STEERING							
	5R4547		P-UB-10	2-1/4	5	CTC-9X6392	160.01
	9J8165		P-UB-10	2-1/4	5	CTC-9X6392	160.01

CATERPILLAR®



## REPLACEMENT KITS FOR CATERPILLAR® EQUIPMENT

Loaders - Wheel							
APPLICATION	CYL #	Misc-Parts, Instructions, etc.	CODE	ROD	BORE	KIT #	List \$
<b>MODEL 988B</b>							
TILT							
	3G2976		P-UB-10	3-1/2	8-1/2	CTC-7X2719	187.84
	4T6792		P-UB-10	3-1/2	7-3/4	CTC-1570284	322.47
	9J3632		P-UB-10	3-1/4	7-3/4	CTC-7X2706	266.70
<b>MODEL 988F</b>							
LIFT							
	9T8257		P-UB-10	4	8-1/2	CTC-7X2742	216.18
STEERING							
	9J8165		P-UB-10	2-1/4	5	CTC-9X6392	160.01
TILT							
	3G2976		P-UB-10	3-1/2	8-1/2	CTC-7X2719	187.84
	4T6792		P-UB-10	3-1/2	7-3/4	CTC-1570284	322.47
	9J3632		P-UB-10	3-1/4	7-3/4	CTC-7X2706	266.70
<b>MODEL 988G</b>							
LIFT							
	1521644		P-UB-10	4-1/2	220 mm	CTC-2295546	369.67
LIFT LH							
	1686943	Logging Arrangement	P-UB-10	5	9-1/4	CTC-1686943K	337.22
LIFT RH							
	1686942	Logging Arrangement	P-UB-10	5	9-1/4	CTC-1686942K	337.22
STEERING LH							
	1338173		P-UB-10	2-1/2	4	CTC-1542501	151.42
	2594733		P-UB-10	2-1/2	4	CTC-2295538	166.28
STEERING RH							
	1353288		P-UB-10	2-1/2	4	CTC-1542501	151.42
	2594737		P-UB-10	2-1/2	4	CTC-2295538	166.28
TILT							
	1521644	High Lift Arrangement	P-UB-10	4-1/2	220 mm	CTC-2295546	369.67
	1686944		P-UB-10	4-1/2	9-1/4	CTC-1686944K	380.96
	2311955		P-UB-10	4-1/2	220 mm	CTC-2295546	369.67
<b>MODEL 990</b>							
STEERING LH							
	6E1244		P-UB-14	3-1/4	5-1/2	CTC-1354539	123.08
STEERING RH							
	9T9568		P-UB-14	3-1/4	5-1/2	CTC-1354539	123.08
TILT							
	1459897		P-UB-10	5-3/4	11-1/2	CTC-1354382	451.31
	9T9570		P-UB-10	5-3/4	11-1/2	CTC-1354382	451.31
<b>MODEL 992, 992B</b>							
LIFT							
	7J8969		P-UB-10	6-1/2	10-1/2	CTC-8T1456	425.14
LIFT LH							
	7J8970		P-UB-10	6-1/2	10-1/2	CTC-8T1456	425.14
	8J5978		P-UB-10	6-1/2	10-1/2	CTC-8T1456	425.14
LIFT RH							
	8J5977		P-UB-10	6-1/2	10-1/2	CTC-8T1456	425.14
STEERING							
	7J9800		P-UB-10	2-1/2	5-1/2	CTC-8T1374	93.39
	8J6339		P-UB-10	2-1/2	5-1/2	CTC-7X2653	162.45
	8J6339		P-UB-10	2-1/2	5-1/2	CTC-8T1374	93.39
	9K5707		P-UB-10	2-1/2	5-1/2	CTC-8T1374	93.39
TILT LH							
	8J6338		P-UB-10	3-1/2	8-1/2	CTC-7X2719	187.84
TILT RH							
	8J6337		P-UB-10	3-1/2	8-1/2	CTC-7X2719	187.84

**CATERPILLAR®**



## REPLACEMENT KITS FOR CATERPILLAR® EQUIPMENT

Loaders - Wheel							
APPLICATION	CYL #	Misc-Parts, Instructions, etc.	CODE	ROD	BORE	KIT #	List \$
<b>MODEL 992C</b>							
LIFT							
	1U1771		P-UB-10	7	11-1/2	CTC-7X2809	446.38
	9J2994		P-UB-10	7	11-1/2	CTC-7X2809	446.38
LIFT HIGH							
	1U1771		P-UB-10	7	11-1/2	CTC-7X2809	446.38
	9J2994		P-UB-10	7	11-1/2	CTC-7X2809	446.38
STEERING							
	9J5419		P-UB-10	3-1/4	7	CTC-7X2710	203.20
TILT HIGH							
	1U1766		P-UB-10	4	10	CTC-7X2811	274.54
	1U1767		P-UB-10	4	10	CTC-7X2811	274.54
TILT LH							
	3G4599		P-UB-14	4	10	CTC-7X2810	230.82
TILT RH							
	3G4598		P-UB-14	4	10	CTC-7X2810	230.82
<b>MODEL 992D</b>							
LIFT							
	1028731		P-UB-10	7	11-1/2	CTC-7X2809	446.38
	1U1771		P-UB-10	7	11-1/2	CTC-7X2809	446.38
	9J2994		P-UB-10	7	11-1/2	CTC-7X2809	446.38
STEERING							
	9J5419		P-UB-10	3-1/4	7	CTC-7X2710	203.20
TILT LH							
	1026248		P-UB-14	4	10	CTC-7X2810	230.82
	1U1767		P-UB-10	4	10	CTC-7X2811	274.54
	3G4599		P-UB-14	4	10	CTC-7X2810	230.82
TILT RH							
	1026247		P-UB-14	4	10	CTC-7X2810	230.82
	1U1766		P-UB-10	4	10	CTC-7X2811	274.54
	3G4598		P-UB-14	4	10	CTC-7X2810	230.82
<b>MODEL 994D</b>							
LIFT							
	3TZ1-UP						
	1934076		P-UB-10	8	12	CTC-2456821	1156.44
	9T9020		P-UB-10	8	12	CTC-2456821	1156.44
LIFT (HI-LIFT)							
	3TZ1-UP						
	1934075		P-UB-10	8	12	CTC-2456821	1156.44
	9T9023		P-UB-10	8	12	CTC-2456821	1156.44
STEERING LH							
	3TZ1-UP						
	6E0529		P-UB-10	4-1/4	7-3/4	CTC-1309763	381.58
	6E0529		P-UB-1	4-1/4		CTC-1309771	267.16
STEERING RH							
	3TZ1-UP						
	9T9019		P-UB-10	4-1/4	7-3/4	CTC-2463431	381.58
	9T9019		P-UB-1	4-1/4		CTC-2463432	267.16
TILT LH							
	3TZ1-UP						
	1123172	CHG 10-	P-UB-10	5-1/2	10-1/2	CTC-2342590	528.38
	1123172		P-UB-10	5-1/2	10-1/2	CTC-2463437	731.57
TILT LH (HI-LIFT)							
	3TZ1-UP						
	1142820		P-UB-10	5-1/2	10-1/2	CTC-2463437	731.57
	2196272	CHG 01-	P-UB-10	5-1/2	10-1/2	CTC-2342590	528.38
	2196272		P-UB-10	5-1/2	10-1/2	CTC-2463437	731.57

CATERPILLAR®



## REPLACEMENT KITS FOR CATERPILLAR® EQUIPMENT

Loaders - Wheel							
APPLICATION	CYL #	Misc-Parts, Instructions, etc.	CODE	ROD	BORE	KIT #	List \$
<b>MODEL 994D</b>							
TILT RH							
3TZ1-UP							
	1123171	CHG 10, 11-	P-UB-10	5-1/2	10-1/2	CTC-2342590	528.38
	1123171		P-UB-10	5-1/2	10-1/2	CTC-2463437	731.57
TILT RH (HI-LIFT)							
3TZ1-UP							
	1142821		P-UB-10	5-1/2	10-1/2	CTC-2463437	731.57
	2196273	CHG 01-	P-UB-10	5-1/2	10-1/2	CTC-2342590	528.38
	2196273		P-UB-10	5-1/2	10-1/2	CTC-2463437	731.57
<b>MODEL G910</b>							
LIFT							
	7J5893		P-UB-10	2	4	CTC-1328816	92.75
	7J5894		P-UB-10	2	4	CTC-1328816	92.75
STEERING							
	1U4666		P-UB-10	1-1/2	2-3/4	CTC-7X2736	126.39
	1U4666		P-UB-10	1-1/2	2-3/4	CTC-8T1402	49.56
TILT							
	1U3165		P-UB-10	1-3/4	3-1/4	CTC-1328770	120.66
	1U4666		P-UB-10	1-1/2	2-3/4	CTC-7X2749	59.06
	7J5885		P-UB-10	1-3/4	3	CTC-7X2791	88.60
	7J5893		P-UB-10	2	4	CTC-7X2789	102.01
	7J5894		P-UB-10	2	4	CTC-7X2789	102.01
<b>MODEL G916</b>							
LIFT							
	4T8648		P-UB-10	2-1/4	4-1/4	CTC-7X2750	114.40
PIN PULLER							
	6E5393		I-O-3	1	2	CTC-9T0418	82.99
STEERING							
	1U3322		P-UB-10	1-1/2	3	CTC-7X2751	64.04
TILT							
	3G6571		P-UB-10	2-1/2	4-3/4	CTC-1328811	161.44
<b>MODEL G926</b>							
LIFT							
	3G2991		P-UB-10	2-1/2	4-3/4	CTC-1328811	161.44
	3G2991		P-UB-10	2-1/2	4-3/4	CTC-7X2660	179.61
PIN PULLER							
	6E5393		I-O-3	1	2	CTC-9T0418	82.99
STEERING							
	3G3501		P-UB-10	1-1/2	3	CTC-7X2751	64.04
TILT							
	3G2798		P-UB-10	2-1/2	5-1/2	CTC-8T3576	90.37
	3G2798		P-UB-10	2-1/2	5-1/2	CTC-9X2047	108.20
<b>MODEL G936</b>							
LIFT							
	4T1674		P-UB-10	2-1/2	5-1/2	CTC-7X2672	88.77
	9T1196		P-UB-10	2-1/2	5-1/2	CTC-7X2672	88.77
PIN PULLER							
	6E5393		I-O-3	1	2	CTC-9T0418	82.99
STEERING							
	3G5110		P-UB-10	1-3/4	3-1/2	CTC-7X2784	56.35
TILT							
	3G5291		P-UB-10	2-3/4	6-1/2	CTC-7X2686	120.72
<b>Motor Graders</b>							
APPLICATION	CYL #	Misc-Parts, Instructions, etc.	CODE	ROD	BORE	KIT #	List \$
<b>MODEL 12</b>							
STEERING							
	4J4115		P-UB-10	1-1/2	4	CTC-7X2738	87.47

**CATERPILLAR®**



## REPLACEMENT KITS FOR CATERPILLAR® EQUIPMENT

<b>Motor Graders</b>							
APPLICATION	CYL #	Misc-Parts, Instructions, etc.	CODE	ROD	BORE	KIT #	List \$
<b>MODEL 12E</b>							
STEERING							
	4J4115		P-UB-10	1-1/2	4	CTC-7X2738	87.47
<b>MODEL 12F</b>							
STEERING							
	4J4115		P-UB-10	1-1/2	4	CTC-7X2738	87.47
<b>MODEL 12G</b>							
ARTICULATION							
	8J0546		P-UB-10	1-3/4	3	CTC-7X2791	88.60
	9T2453		P-UB-10	1-3/4	3	CTC-7X2825	53.69
	9T8784		P-UB-10	1-3/4	3	CTC-7X2825	53.69
BACKHOE STICK/BLADE SHIFT							
	8J0028		P-UB-10	1-3/4	3	CTC-7X2791	88.60
BLADE							
	3G5223		P-UB-10	2	3-1/4	CTC-7X2767	67.91
	8J6380		P-UB-10	2	3-1/4	CTC-7X2767	67.91
	9T2472		P-UB-10	2	3	CTC-7X2753	64.85
	9T2472		P-UB-10	2	3	CTC-7X2760	70.47
BLADE TIP							
	6E1549		P-UB-10	1-1/2	2-3/4	CTC-1361599	106.50
	8J0024		P-UB-10	1-1/2	2-3/4	CTC-7X2749	59.06
	8J0024		P-UB-10	1-1/2	2-3/4	CTC-8T1402	49.56
	9J3466		P-UB-10	1-1/2	2-3/4	CTC-7X2749	59.06
	9T2461		P-UB-10	1-1/2	2-3/4	CTC-1361599	106.50
CENTER SHIFT							
	3G5224		P-UB-10	2	3-1/4	CTC-7X2767	67.91
	9T2549		P-UB-10	2	3	CTC-7X2760	70.47
CONVEYOR SWING							
	3G5224		P-UB-10	2	3-1/4	CTC-7X2767	67.91
	8J6367		P-UB-10	2	3-1/4	CTC-7X2767	67.91
	9T2549		P-UB-10	2	3	CTC-7X2760	70.47
RIPPER							
	1137754		P-UB-10	2	4	CTC-1328816	92.75
	8J1658		P-UB-10	2	4	CTC-1328816	92.75
SCARIFIER							
	3G1853		P-UB-10	1-3/4	3	CTC-7X2791	88.60
	8J7321		P-UB-10	1-1/2	3	CTC-7X2751	64.04
	9T2554		P-UB-10	1-3/4	3	CTC-7X2825	53.69
	9T6951		P-UB-10	1-3/4	3	CTC-7X2825	53.69
SIDESHIFT							
	1052094		P-UB-10	1-3/4	3	CTC-7X2825	53.69
	9T2483		P-UB-10	1-3/4	3	CTC-7X2825	53.69
STEERING LH							
	3G8070		P-UB-10	1-1/2	2-1/2	CTC-7X2739	56.53
	8J8820		P-UB-10	1-1/2	2-1/2	CTC-7X2739	56.53
	9T2395		P-UB-10	1-1/2	2-1/4	CTC-7X2826	40.74
STEERING RH							
	3G8069		P-UB-10	1-1/2	2-1/2	CTC-7X2739	56.53
	8J5538		P-UB-10	1-1/2	2-1/2	CTC-7X2739	56.53
	9T2393		P-UB-10	1-1/2	2-1/4	CTC-7X2826	40.74
WHEEL LEAN							
	1219242		P-UB-10	2	3-1/2	CTC-7X2783	102.97
	3G4752		P-UB-10	1-1/2	3-1/2	CTC-7X2752	95.40
	8J5539		P-UB-10	1-1/2	3-1/2	CTC-7X2752	95.40
	9T2520		P-UB-10	1-1/2	3-1/2	CTC-1327058	103.88

**CATERPILLAR®**





## REPLACEMENT KITS FOR CATERPILLAR® EQUIPMENT

Motor Graders							
APPLICATION	CYL #	Misc-Parts, Instructions, etc.	CODE	ROD	BORE	KIT #	List \$
<b>MODEL 12H</b>							
ARTICULATION							
	6E1560		P-UB-10	1-3/4	3	CTC-7X2825	53.69
	9T8784		P-UB-10	1-3/4	3	CTC-7X2825	53.69
BLADE							
	1324929		P-UB-10	2	3	CTC-7X2760	70.47
BLADE TIP							
	6E1549		P-UB-10	1-1/2	2-3/4	CTC-1361599	106.50
CONVEYOR SWING							
	6E1343		P-UB-10	2	3	CTC-7X2760	70.47
RIPPER							
	1137754		P-UB-10	2	4	CTC-1328816	92.75
SCARIFIER							
	9T2554		P-UB-10	1-3/4	3	CTC-7X2825	53.69
	9T6951		P-UB-10	1-3/4	3	CTC-7X2825	53.69
SIDESHIFT							
	1125575		P-UB-10	1-3/4	3	CTC-7X2825	53.69
STEERING LH							
	9T2395		P-UB-10	1-1/2	2-1/4	CTC-7X2826	40.74
STEERING RH							
	9T2393		P-UB-10	1-1/2	2-1/4	CTC-7X2826	40.74
WHEEL LEAN							
	1219242		P-UB-10	2	3-1/2	CTC-7X2783	102.97
	9T2520		P-UB-10	1-1/2	3-1/2	CTC-1327058	103.88
<b>MODEL 14</b>							
LIFT							
	3G5227		P-UB-10	2-1/4	3-3/4	CTC-7X2798	75.90
STEERING							
	4J4115		P-UB-10	1-1/2	4	CTC-7X2738	87.47
STEERING LH							
	3G7644		P-UB-10	1-1/2	2-3/4	CTC-7X2749	59.06
STEERING RH							
	3G7643		P-UB-10	1-1/2	2-3/4	CTC-7X2749	59.06
<b>MODEL 14D, 140</b>							
STEERING							
	4J4115		P-UB-10	1-1/2	4	CTC-7X2738	87.47
<b>MODEL 14E</b>							
ARTICULATION							
	8J6269		P-UB-10	2	3-1/2	CTC-7X2792	87.78
	9T2879		P-UB-10	2	3-1/2	CTC-7X2783	102.97
BLADE SHIFT							
	4T0340		P-UB-10	2-1/2	4	CTC-7X2665	166.92
	8J6359		P-UB-10	2-1/4	3-3/4	CTC-7X2798	75.90
BLADE TIP							
	4T0379		P-UB-10	2	4	CTC-7X2789	102.01
	9T3198		P-UB-10	2	4	CTC-7X2782	42.64
CENTER SHIFT							
	3G5228		P-UB-10	2-1/4	3-3/4	CTC-7X2798	75.90
DRAWBAR TIP							
	8J6256		P-UB-10	1-1/2	3	CTC-7X2751	64.04
LIFT							
	3G5227		P-UB-10	2-1/4	3-3/4	CTC-7X2798	75.90
	8J6010		P-UB-10	2-1/4	3-3/4	CTC-7X2798	75.90
LIFT RH							
	6J5843		P-UB-10	2-1/2	5	CTC-7X2675	124.26
LIFT RIPPER							
	3G1762		P-UB-10	2-1/2	5	CTC-7X2658	174.24
	3G5189		P-UB-10	2-1/2	5	CTC-7X2658	174.24

CATERPILLAR®



## REPLACEMENT KITS FOR CATERPILLAR® EQUIPMENT

Motor Graders							
APPLICATION	CYL #	Misc-Parts, Instructions, etc.	CODE	ROD	BORE	KIT #	List \$
<b>MODEL 14E</b>							
RIPPER							
	5J7686		P-UB-10	2-1/2	6-1/2	CTC-7X2666	169.85
STEERING							
	1U2704		P-UB-10	2	3-1/2	CTC-7X2792	87.78
	4J4115		P-UB-10	1-1/2	4	CTC-7X2738	87.47
	8J5386		P-UB-10	1-1/2	2-3/4	CTC-7X2749	59.06
	9J0541		P-UB-10	1-1/2	2-3/4	CTC-7X2749	59.06
	9T1301		P-UB-10	1-3/4	2-1/2	CTC-7X2827	40.02
	9T1721		P-UB-10	1-3/4	2-1/2	CTC-7X2827	40.02
STEERING LH							
	3G7644		P-UB-10	1-1/2	2-3/4	CTC-7X2749	59.06
STEERING RH							
	3G7643		P-UB-10	1-1/2	2-3/4	CTC-7X2749	59.06
WHEEL LEAN							
	3G4751		P-UB-10	1-1/2	3-1/2	CTC-7X2752	95.40
	8J5385		P-UB-10	1-1/2	3-1/2	CTC-7X2752	95.40
	9T3219		P-UB-10	1-1/2	3-1/2	CTC-1327058	103.88
<b>MODEL 14G</b>							
ARTICULATION							
	1U2704		P-UB-10	2	3-1/2	CTC-7X2792	87.78
	6E2446		P-UB-10	2	3-1/2	CTC-7X2783	102.97
	6E4724		P-UB-10	2	3-1/2	CTC-7X2783	102.97
	9T2879		P-UB-10	2	3-1/2	CTC-7X2783	102.97
BACKHOE STICK/BLADE SHIFT							
	8J6359		P-UB-10	2-1/4	3-3/4	CTC-7X2798	75.90
BLADE							
	8J6010		P-UB-10	2-1/4	3-3/4	CTC-7X2798	75.90
BLADE LIFT							
	3G5227		P-UB-10	2-1/4	3-3/4	CTC-7X2798	75.90
BLADE TIP							
	9T3198		P-UB-10	2	4	CTC-1328816	92.75
	9T8944		P-UB-10	2	4	CTC-1328816	92.75
CENTER SHIFT							
	3G5228		P-UB-10	2-1/4	3-3/4	CTC-7X2798	75.90
CONVEYOR SWING							
	3G5228		P-UB-10	2-1/4	3-3/4	CTC-7X2798	75.90
	8J6250		P-UB-10	2-1/4	3-3/4	CTC-7X2798	75.90
DRAWBAR TIP							
	8J6256		P-UB-10	1-3/4	3	CTC-7X2791	88.60
LIFT RH							
	6J5843		P-UB-10	2-1/2	5	CTC-7X2675	124.26
RIPPER							
	1135264		P-UB-10	2-1/2	5	CTC-1361967	193.76
	3G1762		P-UB-10	2-1/2	5	CTC-1315106	168.91
	3G5189		P-UB-10	2-1/2	5	CTC-7X2658	174.24
SIDESHIFT							
	4T0340		P-UB-10	2-1/2	4	CTC-7X2665	166.92
	9T3206		P-UB-10	2-1/2	4	CTC-1542501	151.42
STEERING LH							
	3G7644		P-UB-10	1-1/2	2-3/4	CTC-7X2749	59.06
	9J0541		P-UB-10	1-1/2	2-3/4	CTC-7X2749	59.06
	9T1721		P-UB-10	1-3/4	2-1/2	CTC-1539054	144.29
STEERING RH							
	3G7643		P-UB-10	1-1/2	2-3/4	CTC-7X2749	59.06
	8J5386		P-UB-10	1-1/2	2-3/4	CTC-7X2749	59.06
	9T1301		P-UB-10	1-3/4	2-1/2	CTC-1539054	144.29

**CATERPILLAR®**



## REPLACEMENT KITS FOR CATERPILLAR® EQUIPMENT

Motor Graders							
APPLICATION	CYL #	Misc-Parts, Instructions, etc.	CODE	ROD	BORE	KIT #	List \$
<b>MODEL 14G</b>							
TIP							
	4T0379		P-UB-10	2	4	CTC-1328816	92.75
WHEEL LEAN							
	1219243		P-UB-10	2	3-1/2	CTC-7X2783	102.97
	3G4751		P-UB-10	1-1/2	3-1/2	CTC-7X2752	95.40
	8J5385		P-UB-10	1-1/2	3-1/2	CTC-7X2752	95.40
	9T3219		P-UB-10	1-1/2	3-1/2	CTC-1327058	103.88
<b>MODEL 14H</b>							
ARTICULATION							
	6E2446		P-UB-10	2	3-1/2	CTC-7X2783	102.97
	6E4724		P-UB-10	2	3-1/2	CTC-7X2783	102.97
	9T2879		P-UB-10	2	3-1/2	CTC-7X2783	102.97
BLADE TIP							
	9T3198		P-UB-10	2	4	CTC-1328816	92.75
	9T8944		P-UB-10	2	4	CTC-1328816	92.75
RIPPER							
	1135264		P-UB-10	2-1/2	5	CTC-1361967	193.76
SIDESHIFT							
	9T3206		P-UB-10	2-1/2	4	CTC-1542501	151.42
STEERING LH							
	9T1721		P-UB-10	1-3/4	2-1/2	CTC-1539054	144.29
STEERING RH							
	9T1301		P-UB-10	1-3/4	2-1/2	CTC-1539054	144.29
WHEEL LEAN							
	1219243		P-UB-10	2	3-1/2	CTC-7X2783	102.97
	9T3219		P-UB-10	1-1/2	3-1/2	CTC-1327058	103.88
<b>MODEL 16</b>							
BLADE LH							
	6J5844		P-UB-10	2-1/2	5	CTC-7X2675	124.26
BLADE RH							
	6J5843		P-UB-10	2-1/2	5	CTC-7X2675	124.26
LIFT							
	3G5229		P-UB-10	2-1/2	4-1/4	CTC-7X2663	49.39
STEERING							
	5J1931		P-V-10	2	5	CTC-7X2797	70.91
TIP							
	6J9731		P-UB-10	1-1/2	4	CTC-7X2738	87.47
	6J9732		P-UB-10	1-1/2	4	CTC-7X2738	87.47
<b>MODEL 16G</b>							
ARTICULATION							
	1U1649		P-UB-10	2-1/2	4	CTC-7X2665	166.92
	9T3050		P-UB-10	2-1/2	4	CTC-1542501	151.42
BLADE							
	9T3106		P-UB-10	2-1/2	4	CTC-1542501	151.42
BLADE LIFT							
	3G5229		P-UB-10	2-1/2	4-1/4	CTC-7X2663	49.39
	8J5568		P-UB-10	2-1/2	4-1/4	CTC-7X2663	49.39
BLADE TIP							
	6J9731		P-UB-10	1-1/2	4	CTC-7X2738	87.47
	6J9732		P-UB-10	1-1/2	4	CTC-7X2738	87.47
	9T3198		P-UB-10	2	4	CTC-1328816	92.75
	9T8944		P-UB-10	2	4	CTC-1328816	92.75
CENTER SHIFT							
	3G5230		P-UB-10	2-1/2	4-1/4	CTC-7X2663	49.39
CONVEYOR SWING							
	9T3312		P-UB-10	2-1/2	4	CTC-1542501	151.42



## REPLACEMENT KITS FOR CATERPILLAR® EQUIPMENT

Motor Graders							
APPLICATION	CYL #	Misc-Parts, Instructions, etc.	CODE	ROD	BORE	KIT #	List \$
<b>MODEL 16G</b>							
DRAWBAR TIP							
	8J3761		P-UB-10	1-3/4	3	CTC-7X2791	88.60
LIFT							
	8J5827		P-UB-10	2-1/2	4-1/4	CTC-7X2663	49.39
LIFT LH							
	6J5844		P-UB-10	2-1/2	5	CTC-7X2675	124.26
LIFT RH							
	6J5843		P-UB-10	2-1/2	5	CTC-7X2675	124.26
RIPPER							
	1135264		P-UB-10	2-1/2	5	CTC-1361967	193.76
	3G1762		P-UB-10	2-1/2	5	CTC-1315106	168.91
	3G5189		P-UB-10	2-1/2	5	CTC-7X2658	174.24
SIDESHIFT							
	4T0340		P-UB-10	2-1/2	4	CTC-7X2665	166.92
	9T3206		P-UB-10	2-1/2	4	CTC-1542501	151.42
STEERING							
	1U2704		P-UB-10	2	3-1/2	CTC-7X2792	87.78
STEERING LH							
	3G7599		P-UB-10	1-3/4	3	CTC-7X2791	88.60
	8J3612		P-UB-10	1-3/4	3	CTC-7X2791	88.60
	9T2854		P-UB-10	1-3/4	2-3/4	CTC-1539053	150.78
STEERING RH							
	3G7600		P-UB-10	1-3/4	3	CTC-7X2791	88.60
	8J8411		P-UB-10	1-3/4	3	CTC-7X2791	88.60
	9T2853		P-UB-10	1-3/4	2-3/4	CTC-1539053	150.78
	9T2853		P-UB-10	1-3/4	2-3/4	CTC-7X2820	79.12
TIP							
	4T0379		P-UB-10	2	4	CTC-1328816	92.75
WHEEL LEAN							
	1219244		P-UB-10	2-1/4	4	CTC-1361171	101.36
	3G4750		P-UB-10	1-3/4	4	CTC-7X2790	92.96
	8J3613		P-UB-10	1-3/4	4	CTC-1316108	108.64
	9T3492		P-UB-10	1-3/4	4	CTC-1316108	108.64
<b>MODEL 16H</b>							
ARTICULATION							
	9T3050		P-UB-10	2-1/2	4	CTC-1542501	151.42
BLADE							
	9T3106		P-UB-10	2-1/2	4	CTC-1542501	151.42
BLADE TIP							
	9T3198		P-UB-10	2	4	CTC-1328816	92.75
	9T8944		P-UB-10	2	4	CTC-1328816	92.75
CONVEYOR SWING							
	9T3312		P-UB-10	2-1/2	4	CTC-1542501	151.42
RIPPER							
	1135264		P-UB-10	2-1/2	5	CTC-1361967	193.76
SIDESHIFT							
	9T3206		P-UB-10	2-1/2	4	CTC-1542501	151.42
STEERING LH							
	9T2854		P-UB-10	1-3/4	2-3/4	CTC-1539053	150.78
STEERING RH							
	9T2853		P-UB-10	1-3/4	2-3/4	CTC-1539053	150.78
WHEEL LEAN							
	1219244		P-UB-10	2-1/4	4	CTC-1361171	101.36
	9T3492		P-UB-10	1-3/4	4	CTC-1316108	108.64

CATERPILLAR®



## REPLACEMENT KITS FOR CATERPILLAR® EQUIPMENT

<b>Motor Graders</b>							
APPLICATION	CYL #	Misc-Parts, Instructions, etc.	CODE	ROD	BORE	KIT #	List \$
<b>MODEL 24H</b>							
<b>ARTICULATION</b>							
	1170837		P-UB-10	3	4-3/4	CTC-1570288	172.37
	1433033		P-UB-10	3	5	CTC-1605784	72.44
<b>BLADE</b>							
	1170830		P-UB-10	2-1/4	4	CTC-1361171	101.36
	1170832		P-UB-10	3	5-1/4	CTC-3E3293	177.73
<b>RIPPER</b>							
	1137754		P-UB-10	2	4	CTC-1328816	92.75
<b>STEERING</b>							
	1170833		I-UB-10	2-1/2	3-1/2	CTC-3E3299	134.08
<b>TIP</b>							
	1435988	Rod Bearing width- 0.98"	P-UB-10	2-1/2	4-3/4	CTC-1361131	143.18
<b>WHEEL LEAN</b>							
	1170836	Rod Bearing width- 0.98"	P-UB-10	2-1/2	4-3/4	CTC-1361131	143.18
<b>MODEL 112</b>							
<b>STEERING</b>							
	4J4115		P-UB-10	1-1/2	4	CTC-7X2738	87.47
<b>MODEL 112E</b>							
<b>STEERING</b>							
	4J4115		P-UB-10	1-1/2	4	CTC-7X2738	87.47
<b>MODEL 112F</b>							
<b>STEERING</b>							
	4J4115		P-UB-10	1-1/2	4	CTC-7X2738	87.47
<b>MODEL 120</b>							
<b>STEERING</b>							
	4J4115		P-UB-10	1-1/2	4	CTC-7X2738	87.47
<b>MODEL 120B</b>							
<b>STEERING</b>							
	4J4115		P-UB-10	1-1/2	4	CTC-7X2738	87.47
<b>MODEL 120G</b>							
<b>ARTICULATION</b>							
	8J8590		P-UB-10	1-3/4	3	CTC-7X2791	88.60
	9T2447		P-UB-10	1-3/4	3	CTC-7X2825	53.69
	9T8785		P-UB-10	1-3/4	3	CTC-7X2825	53.69
<b>BACKHOE STICK/BLADE SHIFT</b>							
	8J0028		P-UB-10	1-3/4	3	CTC-7X2791	88.60
	9T2483		P-UB-10	1-3/4	3	CTC-7X2825	53.69
<b>BLADE</b>							
	3G5225		P-UB-10	1-3/4	3	CTC-7X2791	88.60
	8J8589		P-UB-10	1-3/4	3	CTC-7X2791	88.60
	9T2471		P-UB-10	1-3/4	3	CTC-7X2825	53.69
<b>BLADE LIFT</b>							
	3G5225		P-UB-10	1-3/4	3	CTC-7X2791	88.60
<b>BLADE RH</b>							
	6J5843		P-UB-10	2-1/2	5	CTC-7X2675	124.26
<b>BLADE TIP</b>							
	6E1549		P-UB-10	1-1/2	2-3/4	CTC-1361599	106.50
	8J0024		P-UB-10	1-1/2	2-3/4	CTC-7X2749	59.06
	9J3466		P-UB-10	1-1/2	2-3/4	CTC-7X2749	59.06
	9T2461		P-UB-10	1-1/2	2-3/4	CTC-1361599	106.50
<b>CENTER SHIFT</b>							
	3G5226		P-UB-10	1-3/4	3	CTC-7X2791	88.60
	8J6367		P-UB-10	2	3-1/4	CTC-7X2767	67.91
	9T2374		P-UB-10	1-3/4	3	CTC-7X2825	53.69

CATERPILLAR®



## REPLACEMENT KITS FOR CATERPILLAR® EQUIPMENT

Motor Graders							
APPLICATION	CYL #	Misc-Parts, Instructions, etc.	CODE	ROD	BORE	KIT #	List \$
<b>MODEL 120G</b>							
CONVEYOR SWING							
	3G5226		P-UB-10	1-3/4	3	CTC-7X2791	88.60
	8J8777		P-UB-10	1-3/4	3	CTC-7X2791	88.60
	9T2374		P-UB-10	1-3/4	3	CTC-7X2825	53.69
SCARIFIER							
	3G1853		P-UB-10	1-3/4	3	CTC-7X2791	88.60
	8J7321		P-UB-10	1-1/2	3	CTC-7X2751	64.04
	9T2554		P-UB-10	1-3/4	3	CTC-7X2825	53.69
	9T6951		P-UB-10	1-3/4	3	CTC-7X2825	53.69
SIDESHIFT							
	1052094		P-UB-10	1-3/4	3	CTC-7X2825	53.69
	8J0028		P-UB-10	1-3/4	3	CTC-7X2791	88.60
	9T2483		P-UB-10	1-3/4	3	CTC-7X2825	53.69
STEERING LH							
	3G8070		P-UB-10	1-1/2	2-1/2	CTC-7X2739	56.53
	8J8820		P-UB-10	1-1/2	2-1/2	CTC-7X2739	56.53
	9T2395		P-UB-10	1-1/2	2-1/4	CTC-7X2826	40.74
STEERING RH							
	3G8069		P-UB-10	1-1/2	2-1/2	CTC-7X2739	56.53
	8J5538		P-UB-10	1-1/2	2-1/2	CTC-7X2739	56.53
	9T2393		P-UB-10	1-1/2	2-1/4	CTC-7X2826	40.74
WHEEL LEAN							
	1219242		P-UB-10	2	3-1/2	CTC-7X2783	102.97
	3G4752		P-UB-10	1-1/2	3-1/2	CTC-7X2752	95.40
	8J5539		P-UB-10	1-1/2	3-1/2	CTC-7X2752	95.40
	9T2520		P-UB-10	1-1/2	3-1/2	CTC-1327058	103.88
<b>MODEL 120H</b>							
ARTICULATION							
	6E1554		P-UB-10	1-3/4	3	CTC-7X2825	53.69
	6E4724		P-UB-10	2	3-1/2	CTC-7X2783	102.97
	9T8785		P-UB-10	1-3/4	3	CTC-7X2825	53.69
BLADE							
	1125575		P-UB-10	1-3/4	3	CTC-7X2825	53.69
	1198664		P-UB-10	2	3	CTC-7X2760	70.47
	1324926		P-UB-10	2	3	CTC-7X2760	70.47
BLADE TIP							
	6E1549		P-UB-10	1-1/2	2-3/4	CTC-1361599	106.50
CONVEYOR SWING							
	6E1754		P-UB-10	2	3	CTC-7X2760	70.47
SCARIFIER							
	9T2554		P-UB-10	1-3/4	3	CTC-7X2825	53.69
	9T6951		P-UB-10	1-3/4	3	CTC-7X2825	53.69
STEERING LH							
	9T2395		P-UB-10	1-1/2	2-1/4	CTC-7X2826	40.74
STEERING RH							
	9T2393		P-UB-10	1-1/2	2-1/4	CTC-7X2826	40.74
WHEEL LEAN							
	1219242		P-UB-10	2	3-1/2	CTC-7X2783	102.97
	9T2520		P-UB-10	1-1/2	3-1/2	CTC-1327058	103.88
<b>MODEL 130G</b>							
ARTICULATION							
	8J0546		P-UB-10	1-3/4	3	CTC-7X2791	88.60
	9T2453		P-UB-10	1-3/4	3	CTC-7X2825	53.69
	9T8784		P-UB-10	1-3/4	3	CTC-7X2825	53.69
BACKHOE STICK/BLADE SHIFT							
	8J0028		P-UB-10	1-3/4	3	CTC-7X2791	88.60
	9T2483		P-UB-10	1-3/4	3	CTC-7X2825	53.69

CATERPILLAR®



## REPLACEMENT KITS FOR CATERPILLAR® EQUIPMENT

Motor Graders							
APPLICATION	CYL #	Misc-Parts, Instructions, etc.	CODE	ROD	BORE	KIT #	List \$
<b>MODEL 130G</b>							
<b>BLADE</b>							
	3G5223		P-UB-10	2	3-1/4	CTC-7X2767	67.91
	8J6380		P-UB-10	2	3-1/4	CTC-7X2767	67.91
	9T2472		P-UB-10	2	3	CTC-7X2760	70.47
<b>BLADE LIFT</b>							
	3G5223		P-UB-10	2	3-1/4	CTC-7X2767	67.91
	9T2471		P-UB-10	1-3/4	3	CTC-7X2825	53.69
	9T2472		P-UB-10	2	3	CTC-7X2753	64.85
<b>BLADE TIP</b>							
	6E1549		P-UB-10	1-1/2	2-3/4	CTC-1361599	106.50
	8J0024		P-UB-10	1-1/2	2-3/4	CTC-7X2749	59.06
	9J3466		P-UB-10	1-1/2	2-3/4	CTC-7X2749	59.06
	9T2461		P-UB-10	1-1/2	2-3/4	CTC-1361599	106.50
<b>CENTER SHIFT</b>							
	3G5224		P-UB-10	2	3-1/4	CTC-7X2767	67.91
	8J6367		P-UB-10	2	3-1/4	CTC-7X2767	67.91
	9T2549		P-UB-10	2	3	CTC-7X2760	70.47
<b>CONVEYOR SWING</b>							
	3G5224		P-UB-10	2	3-1/4	CTC-7X2767	67.91
	8J6367		P-UB-10	2	3-1/4	CTC-7X2767	67.91
	9T2549		P-UB-10	2	3	CTC-7X2760	70.47
<b>LIFT</b>							
	9T2471		P-UB-10	1-3/4	3	CTC-7X2825	53.69
<b>RIPPER</b>							
	1137754		P-UB-10	2	4	CTC-1328816	92.75
	8J1658		P-UB-10	2	4	CTC-1328816	92.75
<b>SCARIFIER</b>							
	3G1853		P-UB-10	1-3/4	3	CTC-7X2791	88.60
	8J7321		P-UB-10	1-1/2	3	CTC-7X2751	64.04
	9T2554		P-UB-10	1-3/4	3	CTC-7X2825	53.69
	9T6951		P-UB-10	1-3/4	3	CTC-7X2825	53.69
<b>SIDESHIFT</b>							
	1052094		P-UB-10	1-3/4	3	CTC-7X2825	53.69
	8J0028		P-UB-10	1-3/4	3	CTC-7X2791	88.60
	9T2483		P-UB-10	1-3/4	3	CTC-7X2825	53.69
<b>STEERING LH</b>							
	3G8070		P-UB-10	1-1/2	2-1/2	CTC-7X2739	56.53
	8J8820		P-UB-10	1-1/2	2-1/2	CTC-7X2739	56.53
	9T2395		P-UB-10	1-1/2	2-1/4	CTC-7X2826	40.74
<b>STEERING RH</b>							
	3G8069		P-UB-10	1-1/2	2-1/2	CTC-7X2739	56.53
	8J5538		P-UB-10	1-1/2	2-1/2	CTC-7X2739	56.53
	9T2393		P-UB-10	1-1/2	2-1/4	CTC-7X2826	40.74
<b>WHEEL LEAN</b>							
	1219242		P-UB-10	2	3-1/2	CTC-7X2783	102.97
	3G4752		P-UB-10	1-1/2	3-1/2	CTC-7X2752	95.40
	8J5539		P-UB-10	1-1/2	3-1/2	CTC-7X2752	95.40
	9T2520		P-UB-10	1-1/2	3-1/2	CTC-1327058	103.88
<b>MODEL 135H</b>							
<b>ARTICULATION</b>							
	6E1554		P-UB-10	1-3/4	3	CTC-7X2825	53.69
	6E4724		P-UB-10	2	3-1/2	CTC-7X2783	102.97
	9T8785		P-UB-10	1-3/4	3	CTC-7X2825	53.69
<b>BLADE</b>							
	1324926		P-UB-10	2	3	CTC-7X2760	70.47
<b>BLADE TIP</b>							
	6E1549		P-UB-10	1-1/2	2-3/4	CTC-1361599	106.50

CATERPILLAR®





## REPLACEMENT KITS FOR CATERPILLAR® EQUIPMENT

<b>Motor Graders</b>							
APPLICATION	CYL #	Misc-Parts, Instructions, etc.	CODE	ROD	BORE	KIT #	List \$
<b>MODEL 135H</b>							
CONVEYOR SWING							
	6E1754		P-UB-10	2	3	CTC-7X2760	70.47
SCARIFIER							
	9T2554		P-UB-10	1-3/4	3	CTC-7X2825	53.69
	9T6951		P-UB-10	1-3/4	3	CTC-7X2825	53.69
SIDESHIFT							
	1125575		P-UB-10	1-3/4	3	CTC-7X2825	53.69
STEERING LH							
	9T2395		P-UB-10	1-1/2	2-1/4	CTC-7X2826	40.74
STEERING RH							
	9T2393		P-UB-10	1-1/2	2-1/4	CTC-7X2826	40.74
WHEEL LEAN							
	1219242		P-UB-10	2	3-1/2	CTC-7X2783	102.97
	9T2520		P-UB-10	1-1/2	3-1/2	CTC-1327058	103.88
<b>MODEL 140B</b>							
RIPPER							
	3G5189		P-UB-10	2-1/2	5	CTC-7X2658	174.24
STEERING							
	4J4115		P-UB-10	1-1/2	4	CTC-7X2738	87.47
<b>MODEL 140G</b>							
ARTICULATION							
	8J0546		P-UB-10	1-3/4	3	CTC-7X2791	88.60
	9T2453		P-UB-10	1-3/4	3	CTC-7X2825	53.69
	9T8784		P-UB-10	1-3/4	3	CTC-7X2825	53.69
BACKHOE STICK/BLADE SHIFT							
	8J0028		P-UB-10	1-3/4	3	CTC-7X2791	88.60
BLADE							
	3G5223		P-UB-10	2	3-1/4	CTC-7X2767	67.91
	8J6380		P-UB-10	2	3-1/4	CTC-7X2767	67.91
	9T2472		P-UB-10	2	3	CTC-7X2760	70.47
BLADE LIFT							
	9T2472		P-UB-10	2	3	CTC-7X2753	64.85
BLADE TIP							
	6E1549		P-UB-10	1-1/2	2-3/4	CTC-1361599	106.50
	8J0024		P-UB-10	1-1/2	2-3/4	CTC-7X2749	59.06
	9J3466		P-UB-10	1-1/2	2-3/4	CTC-7X2749	59.06
	9T2461		P-UB-10	1-1/2	2-3/4	CTC-1361599	106.50
CENTER SHIFT							
	3G5224		P-UB-10	2	3-1/4	CTC-7X2767	67.91
	8J6367		P-UB-10	2	3-1/4	CTC-7X2767	67.91
	9T2549		P-UB-10	2	3	CTC-7X2760	70.47
CONVEYOR SWING							
	3G5224		P-UB-10	2	3-1/4	CTC-7X2767	67.91
	8J6367		P-UB-10	2	3-1/4	CTC-7X2767	67.91
	9T2549		P-UB-10	2	3	CTC-7X2760	70.47
RIPPER							
	1137754		P-UB-10	2	4	CTC-1328816	92.75
	8J1658		P-UB-10	2	4	CTC-1328816	92.75
RIPPER LIFT							
	3G5189		P-UB-10	2-1/2	5	CTC-7X2658	174.24
SCARIFIER							
	3G1853		P-UB-10	1-3/4	3	CTC-7X2791	88.60
	8J7321		P-UB-10	1-1/2	3	CTC-7X2751	64.04
	9T2554		P-UB-10	1-3/4	3	CTC-7X2825	53.69
	9T6951		P-UB-10	1-3/4	3	CTC-7X2825	53.69

**CATERPILLAR®**



## REPLACEMENT KITS FOR CATERPILLAR® EQUIPMENT

Motor Graders							
APPLICATION	CYL #	Misc-Parts, Instructions, etc.	CODE	ROD	BORE	KIT #	List \$
<b>MODEL 140G</b>							
SIDESHIFT							
	1052094		P-UB-10	1-3/4	3	CTC-7X2825	53.69
	8J0028		P-UB-10	1-3/4	3	CTC-7X2791	88.60
	9T2483		P-UB-10	1-3/4	3	CTC-7X2825	53.69
STEERING LH							
	3G8070		P-UB-10	1-1/2	2-1/2	CTC-7X2739	56.53
	8J8820		P-UB-10	1-1/2	2-1/2	CTC-7X2739	56.53
	9T2395		P-UB-10	1-1/2	2-1/4	CTC-7X2826	40.74
STEERING RH							
	3G8069		P-UB-10	1-1/2	2-1/2	CTC-7X2739	56.53
	8J5538		P-UB-10	1-1/2	2-1/2	CTC-7X2739	56.53
	9T2393		P-UB-10	1-1/2	2-1/4	CTC-7X2826	40.74
WHEEL LEAN							
	1219242		P-UB-10	2	3-1/2	CTC-7X2783	102.97
	3G4752		P-UB-10	1-1/2	3-1/2	CTC-7X2752	95.40
	4J4115		P-UB-10	1-1/2	4	CTC-7X2738	87.47
	8J5539		P-UB-10	1-1/2	3-1/2	CTC-7X2752	95.40
	9T2520		P-UB-10	1-1/2	3-1/2	CTC-1327058	103.88
<b>MODEL 140H, 143H</b>							
ARTICULATION							
	1376790		P-UB-10	1-7/8	3-1/4	CTC-3E3297	98.56
	1376792		P-UB-10	1-7/8	3-1/4	CTC-3E3297	98.56
	6E1560		P-UB-10	1-3/4	3	CTC-7X2825	53.69
	9T8784		P-UB-10	1-3/4	3	CTC-7X2825	53.69
BLADE							
	1324929		P-UB-10	2	3	CTC-7X2760	70.47
BLADE TIP							
	6E1549		P-UB-10	1-1/2	2-3/4	CTC-1361599	106.50
CONVEYOR SWING							
	6E1343		P-UB-10	2	3	CTC-7X2760	70.47
RIPPER							
	1137754		P-UB-10	2	4	CTC-1328816	92.75
SCARIFIER							
	9T2554		P-UB-10	1-3/4	3	CTC-7X2825	53.69
	9T6951		P-UB-10	1-3/4	3	CTC-7X2825	53.69
SIDESHIFT							
	1125575		P-UB-10	1-3/4	3	CTC-7X2825	53.69
STEERING LH							
	9T2395		P-UB-10	1-1/2	2-1/4	CTC-7X2826	40.74
STEERING RH							
	9T2393		P-UB-10	1-1/2	2-1/4	CTC-7X2826	40.74
WHEEL LEAN							
	1219242		P-UB-10	2	3-1/2	CTC-7X2783	102.97
	9T2520		P-UB-10	1-1/2	3-1/2	CTC-1327058	103.88
<b>MODEL 160G</b>							
ARTICULATION							
	8J0546		P-UB-10	1-3/4	3	CTC-7X2791	88.60
	9T2453		P-UB-10	1-3/4	3	CTC-7X2825	53.69
	9T8784		P-UB-10	1-3/4	3	CTC-7X2825	53.69
BACKHOE STICK/BLADE SHIFT							
	8J0028		P-UB-10	1-3/4	3	CTC-7X2791	88.60
BLADE							
	3G5223		P-UB-10	2	3-1/4	CTC-7X2767	67.91
	8J6380		P-UB-10	2	3-1/4	CTC-7X2767	67.91
	9T2472		P-UB-10	2	3	CTC-7X2753	64.85
	9T2472		P-UB-10	2	3	CTC-7X2760	70.47

CATERPILLAR®



## REPLACEMENT KITS FOR CATERPILLAR® EQUIPMENT

<b>Motor Graders</b>							
APPLICATION	CYL #	Misc-Parts, Instructions, etc.	CODE	ROD	BORE	KIT #	List \$
<b>MODEL 160G</b>							
<b>BLADE LIFT</b>							
	3G5223		P-UB-10	2	3-1/4	CTC-7X2767	67.91
	9T2472		P-UB-10	2	3	CTC-7X2753	64.85
<b>BLADE TIP</b>							
	6E1549		P-UB-10	1-1/2	2-3/4	CTC-1361599	106.50
	8J0024		P-UB-10	1-1/2	2-3/4	CTC-7X2749	59.06
	9J3466		P-UB-10	1-1/2	2-3/4	CTC-7X2749	59.06
	9T2461		P-UB-10	1-1/2	2-3/4	CTC-1361599	106.50
<b>CENTER SHIFT</b>							
	3G5224		P-UB-10	2	3-1/4	CTC-7X2767	67.91
	9T2549		P-UB-10	2	3	CTC-7X2760	70.47
<b>CONVEYOR SWING</b>							
	3G5224		P-UB-10	2	3-1/4	CTC-7X2767	67.91
	8J6367		P-UB-10	2	3-1/4	CTC-7X2767	67.91
	9T2549		P-UB-10	2	3	CTC-7X2760	70.47
<b>SCARIFIER</b>							
	3G1853		P-UB-10	1-3/4	3	CTC-7X2791	88.60
	9T2554		P-UB-10	1-3/4	3	CTC-7X2825	53.69
	9T6951		P-UB-10	1-3/4	3	CTC-7X2825	53.69
<b>SIDESHIFT</b>							
	1052094		P-UB-10	1-3/4	3	CTC-7X2825	53.69
	8J0028		P-UB-10	1-3/4	3	CTC-7X2791	88.60
	9T2483		P-UB-10	1-3/4	3	CTC-7X2825	53.69
<b>STEERING LH</b>							
	3G8070		P-UB-10	1-1/2	2-1/2	CTC-7X2739	56.53
	8J8820		P-UB-10	1-1/2	2-1/2	CTC-7X2739	56.53
	9T2395		P-UB-10	1-1/2	2-1/4	CTC-7X2826	40.74
<b>STEERING RH</b>							
	3G8069		P-UB-10	1-1/2	2-1/2	CTC-7X2739	56.53
	8J5538		P-UB-10	1-1/2	2-1/2	CTC-7X2739	56.53
	9T2393		P-UB-10	1-1/2	2-1/4	CTC-7X2826	40.74
<b>WHEEL LEAN</b>							
	1219242		P-UB-10	2	3-1/2	CTC-7X2783	102.97
	3G4752		P-UB-10	1-1/2	3-1/2	CTC-7X2752	95.40
	9T2520		P-UB-10	1-1/2	3-1/2	CTC-1327058	103.88
<b>MODEL 160H, 163H</b>							
<b>ARTICULATION</b>							
	1376790		P-UB-10	1-7/8	3-1/4	CTC-3E3297	98.56
	1376792		P-UB-10	1-7/8	3-1/4	CTC-3E3297	98.56
	6E1560		P-UB-10	1-3/4	3	CTC-7X2825	53.69
	9T8784		P-UB-10	1-3/4	3	CTC-7X2825	53.69
<b>BLADE</b>							
	1324929		P-UB-10	2	3	CTC-7X2760	70.47
<b>BLADE TIP</b>							
	6E1549		P-UB-10	1-1/2	2-3/4	CTC-1361599	106.50
<b>CONVEYOR SWING</b>							
	6E1343		P-UB-10	2	3	CTC-7X2760	70.47
<b>RIPPER</b>							
	1137754		P-UB-10	2	4	CTC-1328816	92.75
<b>SCARIFIER</b>							
	9T2554		P-UB-10	1-3/4	3	CTC-7X2825	53.69
	9T6951		P-UB-10	1-3/4	3	CTC-7X2825	53.69
<b>SIDESHIFT</b>							
	1125575		P-UB-10	1-3/4	3	CTC-7X2825	53.69
<b>STEERING LH</b>							
	9T2395		P-UB-10	1-1/2	2-1/4	CTC-7X2826	40.74

**CATERPILLAR®**



## REPLACEMENT KITS FOR CATERPILLAR® EQUIPMENT

<b>Motor Graders</b>							
APPLICATION	CYL #	Misc-Parts, Instructions, etc.	CODE	ROD	BORE	KIT #	List \$
<b>MODEL 160H, 163H</b>							
STEERING RH							
	9T2393		P-UB-10	1-1/2	2-1/4	CTC-7X2826	40.74
WHEEL LEAN							
	1219242		P-UB-10	2	3-1/2	CTC-7X2783	102.97
	9T2520		P-UB-10	1-1/2	3-1/2	CTC-1327058	103.88
<b>Off-Highway Trucks</b>							
APPLICATION	CYL #	Misc-Parts, Instructions, etc.	CODE	ROD	BORE	KIT #	List \$
<b>MODEL 768</b>							
HOIST							
	4T4168		I-SP-10	4,6-1/2	5-3/4	CTC-8T4772	314.53
STEERING							
	9J1287		P-UB-10	2-3/8	3-3/4	CTC-7X2808	80.64
SUSPENSION REAR							
	5J6572		I-SP-1	7	8-1/2	CTC-5J6572K	227.47
<b>MODEL 768B</b>							
STEERING							
	7J7528		P-UB-10	2-3/8	3-3/4	CTC-7X2808	80.64
	9J1287		P-UB-10	2-3/8	3-3/4	CTC-7X2808	80.64
SUSPENSION FRONT							
	79S1; 02X1-						
			P-UB-3	7	8	CTC-1137475	457.29
SUSPENSION REAR							
			P-U-3	7	8-1/2	CTC-2959886	274.89
	5J6572		I-SP-1	7	8-1/2	CTC-5J6572K	227.47
<b>MODEL 768C</b>							
HOIST							
	9J4149		I-SP-10	4,6-1/2	5-3/4	CTC-8T4772	314.53
STEERING							
			P-UB-10	2-3/8	3-3/4	CTC-2578422	52.88
			P-UB-10	2	3	CTC-2937596	40.04
SUSPENSION							
	1162836		P-U-3	7	8-1/2	CTC-1417296	273.31
SUSPENSION FRONT							
	79S1; 02X1-						
			P-UB-3	7	8	CTC-1137475	457.29
SUSPENSION REAR							
			P-U-3	7	8-1/2	CTC-2959886	274.89
	5J6572		I-SP-1	7	8-1/2	CTC-5J6572K	227.47
<b>MODEL 769, 769B</b>							
STEERING							
			P-UB-10	2-3/8	3-3/4	CTC-2578422	52.88
	4J4627	Field Replacement Kit	P-UB-10	1-1/2	3-1/2	CTC-7X2812	104.03
99F1031-99F1198							
	6J1203		I-UB-10	2-3/8	3-3/4	CTC-6J1203K	117.56
99F1199-99F4068							
	7J7528		P-UB-10	2-3/8	3-3/4	CTC-7X2808	80.64
99F1-99F1030							
	4J4627		I,P-V-10	1-1/2	3-1/2	CTC-4J4627K	83.64
99F4069-							
	9J1287		P-UB-10	2-3/8	3-3/4	CTC-7X2808	80.64
SUSPENSION							
	7J8286		P-UB-3	7	8	CTC-1137475	457.29
SUSPENSION REAR							
	99F1031-; 35W						
	5J6572		I-SP-1	7	8-1/2	CTC-5J6572K	227.47
99F1-99F1030							
	4J8770		I-SP-1	7	8-1/2	CTC-4J8770K	214.92



## REPLACEMENT KITS FOR CATERPILLAR® EQUIPMENT

Off-Highway Trucks							
APPLICATION	CYL #	Misc-Parts, Instructions, etc.	CODE	ROD	BORE	KIT #	List \$
<b>MODEL 769C</b>							
HOIST							
	4T4168		I-SP-10	4,6-1/2	5-3/4	CTC-8T4772	314.53
	9J4149		I-SP-10	4,6-1/2	5-3/4	CTC-8T4772	314.53
STEERING							
			P-UB-10	2-3/8	3-3/4	CTC-2578422	52.88
			P-UB-10	2	3	CTC-2937596	40.04
SUSPENSION							
	1162836		P-U-3	7	8-1/2	CTC-1417296	273.31
SUSPENSION FRONT							
			P-UB-3	7	8	CTC-2950148	655.52
	01X2920-; 3BJ1-; 5TR; 6JR; 5SS; 6YS; 9XS; BCA; BBB						
			P-UB-3	7	8	CTC-1137475	457.29
SUSPENSION REAR							
			P-U-3	7	8-1/2	CTC-2959886	274.89
	5J6572		I-SP-1	7	8-1/2	CTC-5J6572K	227.47
	1X1-1X3271						
	3G0688		I-SP-1	7	8-1/2	CTC-5J6572K	227.47
	1X3272-						
	3G0688		I-SP-1	7	8-1/2	CTC-3G0688K	227.47
<b>MODEL 769D</b>							
HOIST							
	4T4168		I-SP-10	4,6-1/2	5-3/4	CTC-8T4772	314.53
	9J4149		I-SP-10	4,6-1/2	5-3/4	CTC-8T4772	314.53
STEERING							
			P-UB-10	2	3	CTC-2937596	40.04
	1100532		P-UB-10	2	3	CTC-7X2760	70.47
	9J1287		P-UB-10	2-3/8	3-3/4	CTC-7X2808	80.64
SUSPENSION							
	1162836		P-U-3	7	8-1/2	CTC-1417296	273.31
SUSPENSION FRONT							
	01X2920-; 3BJ1-; 5TR; 6JR; 5SS; 6YS; 9XS; BCA; BBB						
			P-UB-3	7	8	CTC-1137475	457.29
SUSPENSION REAR							
			P-U-3	7	8-1/2	CTC-2959886	274.89
UNSPECIFIED APPLICATION							
	1303921		P-UB-3	7	8	CTC-1137475	457.29
<b>MODEL 770</b>							
STEERING							
			P-UB-10	2	3	CTC-2937596	40.04
<b>MODEL 771C</b>							
HOIST							
	4T4168		I-SP-10	4,6-1/2	5-3/4	CTC-8T4772	314.53
	9J4149		I-SP-10	4,6-1/2	5-3/4	CTC-8T4772	314.53
STEERING							
			P-UB-10	2	3	CTC-2937596	40.04
	9J1287		P-UB-10	2-3/8	3-3/4	CTC-7X2808	80.64
SUSPENSION							
	1162836		P-U-3	7	8-1/2	CTC-1417296	273.31
SUSPENSION FRONT							
			P-UB-3	7	8	CTC-2950148	655.52
	01X2920-; 3BJ1-; 5TR; 6JR; 5SS; 6YS; 9XS; BCA; BBB						
			P-UB-3	7	8	CTC-1137475	457.29
SUSPENSION REAR							
			P-U-3	7	8-1/2	CTC-2959886	274.89
UNSPECIFIED APPLICATION							
	9J5476		P-UB-3	7	8	CTC-1137475	457.29

**CATERPILLAR®**



## REPLACEMENT KITS FOR CATERPILLAR® EQUIPMENT

Off-Highway Trucks							
APPLICATION	CYL #	Misc-Parts, Instructions, etc.	CODE	ROD	BORE	KIT #	List \$
<b>MODEL 771D</b>							
HOIST							
	4T4168		I-SP-10	4,6-1/2	5-3/4	CTC-8T4772	314.53
	9J4149		I-SP-10	4,6-1/2	5-3/4	CTC-8T4772	314.53
STEERING							
			P-UB-10	2	3	CTC-2937596	40.04
	1100532		P-UB-10	2	3	CTC-7X2760	70.47
	9J1287		P-UB-10	2-3/8	3-3/4	CTC-7X2808	80.64
SUSPENSION							
	1162836		P-U-3	7	8-1/2	CTC-1417296	273.31
SUSPENSION FRONT							
	01X2920-; 3BJ1-; 5TR; 6JR; 5SS; 6YS; 9XS; BCA; BBB						
			P-UB-3	7	8	CTC-1137475	457.29
SUSPENSION REAR							
			P-U-3	7	8-1/2	CTC-2959886	274.89
<b>MODEL 772, 772B</b>							
DOOR							
	3G4640		P-UB-10	2-1/2	6	CTC-7X2669	233.76
	9J8157		P-UB-14	2-1/2	6	CTC-7X2836	256.92
HOIST							
	9J2017	772B only	I-SP-10	5,7-1/2	8-1/4	CTC-8T9042	455.14
	9T3122	772B only	I-SP-10	5,7-1/2	8-1/4	CTC-8T9042	455.14
STEERING							
			P-UB-10	2-3/8	4	CTC-2418925	56.47
			P-UB-10	2	3	CTC-2937596	40.04
SUSPENSION							
	8J2322		P-UB-3	7	8	CTC-1137475	457.29
SUSPENSION FRONT							
			P-UB-3	7	8	CTC-2950148	655.52
	1U4777		P-UB-3	7	8	CTC-1137478	655.52
	7J3480		P-UB-3	7	8	CTC-1137475	457.29
	64W168-						
			P-UB-3	7	8	CTC-1137478	655.52
SUSPENSION REAR							
			P-U-3	7	8-1/2	CTC-2959886	274.89
UNSPECIFIED APPLICATION							
	1163092		P-UB-3	7	8	CTC-1137478	655.52
<b>MODEL 772E</b>							
SUSPENSION REAR							
			P-U-3	7	8-1/2	CTC-2959886	274.89
<b>MODEL 773</b>							
STEERING							
			P-UB-10	2-3/8	4	CTC-2418925	56.47
SUSPENSION FRONT							
	63G-63G670						
	7J3480		P-UB-3	7	8	CTC-1137475	457.29
	63G671-						
	8J2322		P-UB-3	7	8	CTC-1137475	457.29
	63W1271-; 7XJ1-; 6KR; 7ER; 7CS; 8AS						
			P-UB-3	7	8	CTC-1137478	655.52
SUSPENSION REAR							
	63G; 63W1-63W1724						
	8J9332		I-SP-1	7	8-1/2	CTC-5J6572K	227.47
	63W1725-						
	8J9332		I-SP-1	7	8-1/2	CTC-3G0688K	227.47
<b>MODEL 773B</b>							
DOOR							
	3G4640		P-UB-10	2-1/2	6	CTC-7X2669	233.76



## REPLACEMENT KITS FOR CATERPILLAR® EQUIPMENT

Off-Highway Trucks							
APPLICATION	CYL #	Misc-Parts, Instructions, etc.	CODE	ROD	BORE	KIT #	List \$
<b>MODEL 773B</b>							
HOIST							
			I-SP-10	5,7-1/2	6-1/2,8-1/4	CTC-3126388	480.32
	9J2017		I-SP-10	5,7-1/2	8-1/4	CTC-8T9042	455.14
	9T3122		I-SP-10	5,7-1/2	8-1/4	CTC-8T9042	455.14
STEERING RH							
	63G1-; 63W1-						
	7J7686		P-UB-10	2-3/8	4	CTC-8T1389	47.61
SUSPENSION							
	1162837		P-U-3	7	8-1/2	CTC-1417296	273.31
SUSPENSION FRONT							
			P-UB-3	7	8	CTC-2950148	655.52
	63W1271-; 7XJ1-; 6KR; 7ER; 7CS; 8AS						
			P-UB-3	7	8	CTC-1137478	655.52
SUSPENSION REAR							
	9T6082		P-U-3	7	8-1/2	CTC-1417296	273.31
	63G; 63W1-63W1724						
	8J9332		I-SP-1	7	8-1/2	CTC-5J6572K	227.47
	63W1725-						
	8J9332		I-SP-1	7	8-1/2	CTC-3G0688K	227.47
UNSPECIFIED APPLICATION							
	1163092		P-UB-3	7	8	CTC-1137478	655.52
<b>MODEL 773D</b>							
HOIST							
			I-SP-10	5,7-1/2	6-1/2,8-1/4	CTC-3126388	480.32
	1455155		I-SP-10	5,7-1/2	8-1/4	CTC-8T9042	455.14
	9J2017		I-SP-10	5,7-1/2	8-1/4	CTC-8T9042	455.14
STEERING RH							
	7J7686		P-UB-10	2-3/8	4	CTC-8T1389	47.61
SUSPENSION							
	1162837		P-U-3	7	8-1/2	CTC-1417296	273.31
SUSPENSION FRONT							
			P-UB-3	7	8	CTC-2950148	655.52
	1163092		P-UB-3	7	8	CTC-1137478	655.52
	1U4777		P-UB-3	7	8	CTC-1137478	655.52
	63W1271-; 7XJ1-; 6KR; 7ER; 7CS; 8AS						
			P-UB-3	7	8	CTC-1137478	655.52
SUSPENSION REAR							
	9T6082		P-U-3	7	8-1/2	CTC-1417296	273.31
<b>MODEL 773E</b>							
HOIST							
			I-SP-10	5,7-1/2	6-1/2,8-1/4	CTC-3126388	480.32
STEERING							
			P-UB-10	2-1/2	3-1/2	CTC-2949583	70.16
SUSPENSION FRONT							
			P-UB-3	7	8	CTC-2950148	655.52
SUSPENSION REAR							
			P-U-3	7	8-1/2	CTC-2976848	284.64
<b>MODEL 773F</b>							
SUSPENSION REAR							
			P-U-3	7	8-1/2	CTC-2976848	284.64
<b>MODEL 775</b>							
HOIST							
	9J2017		I-SP-10	5,7-1/2	8-1/4	CTC-8T9042	455.14
	9T3122		I-SP-10	5,7-1/2	8-1/4	CTC-8T9042	455.14
STEERING RH							
	7J7686		P-UB-10	2-3/8	4	CTC-8T1389	47.61

CATERPILLAR®





## REPLACEMENT KITS FOR CATERPILLAR® EQUIPMENT

Off-Highway Trucks							
APPLICATION	CYL #	Misc-Parts, Instructions, etc.	CODE	ROD	BORE	KIT #	List \$
<b>MODEL 775</b>							
SUSPENSION							
	1162837		P-U-3	7	8-1/2	CTC-1417296	273.31
SUSPENSION REAR							
	9T6082		P-U-3	7	8-1/2	CTC-1417296	273.31
UNSPECIFIED APPLICATION							
	1163092		P-UB-3	7	8	CTC-1137478	655.52
	1U4777		P-UB-3	7	8	CTC-1137478	655.52
<b>MODEL 775B</b>							
HOIST							
			I-SP-10	5,7-1/2	6-1/2,8-1/4	CTC-3126388	480.32
SUSPENSION							
	1U4777		P-UB-3	7	8	CTC-1137478	655.52
SUSPENSION FRONT							
			P-UB-3	7	8	CTC-2950148	655.52
	63W1271-; 7XJ1-; 6KR; 7ER; 7CS; 8AS						
			P-UB-3	7	8	CTC-1137478	655.52
SUSPENSION REAR							
			P-U-3	7	8-1/2	CTC-2959886	274.89
<b>MODEL 775D</b>							
HOIST							
			I-SP-10	5,7-1/2	6-1/2,8-1/4	CTC-3126388	480.32
	1455155		I-SP-10	5,7-1/2	8-1/4	CTC-8T9042	455.14
	9J2017		I-SP-10	5,7-1/2	8-1/4	CTC-8T9042	455.14
	9T3122		I-SP-10	5,7-1/2	8-1/4	CTC-8T9042	455.14
STEERING RH							
	7J7686		P-UB-10	2-3/8	4	CTC-8T1389	47.61
SUSPENSION							
	1162837		P-U-3	7	8-1/2	CTC-1417296	273.31
SUSPENSION FRONT							
			P-UB-3	7	8	CTC-2950148	655.52
	63W1271-; 7XJ1-; 6KR; 7ER; 7CS; 8AS						
			P-UB-3	7	8	CTC-1137478	655.52
SUSPENSION REAR							
			P-U-3	7	8-1/2	CTC-2959886	274.89
UNSPECIFIED APPLICATION							
	1163092		P-UB-3	7	8	CTC-1137478	655.52
	1U4777		P-UB-3	7	8	CTC-1137478	655.52
	9T6082		P-U-3	7	8-1/2	CTC-1417296	273.31
<b>MODEL 776, 776B</b>							
DOOR							
	3G4640		P-UB-10	2-1/2	6	CTC-7X2669	233.76
STEERING							
			P-UB-10	2-3/8	4	CTC-2418925	56.47
SUSPENSION REAR							
	8J8865		I,P-U-13	9	10-1/2	CTC-1137482	357.02
<b>MODEL 776C, 776D</b>							
STEERING							
	8J9912		P-UB-10	2-3/8	4	CTC-8T1389	47.61
SUSPENSION REAR							
			P-UB-1	9	10-1/2	CTC-2959885	263.81
	8J8865		I,P-U-13	9	10-1/2	CTC-1137482	357.02
<b>MODEL 777</b>							
DOOR							
	3G4640		P-UB-10	2-1/2	6	CTC-7X2669	233.76
HOIST							
	8J8924		I-UB-10	5-1/2	9-1/2	CTC-8T1543	460.28



## REPLACEMENT KITS FOR CATERPILLAR® EQUIPMENT

Off-Highway Trucks							
APPLICATION	CYL #	Misc-Parts, Instructions, etc.	CODE	ROD	BORE	KIT #	List \$
<b>MODEL 777</b>							
STEERING							
			P-UB-10	2-3/8	4	CTC-1945600	56.42
			P-UB-10	2-3/8	4	CTC-2418925	56.47
SUSPENSION FRONT							
	4T4756		I,P-U-3	9	10-3/4	CTC-1137463	1884.15
SUSPENSION REAR							
	8J8865		I,P-U-13	9	10-1/2	CTC-1137482	357.02
	84A1284-; 4YC1-						
	8J8865		I-SP-1	9	10-1/2	CTC-9T3972K	477.26
	84A1-84A1283						
	8J8865		I-SP-1	9	10-1/2	CTC-8J8902K	477.26
<b>MODEL 777B</b>							
HOIST							
	8J8924		I-UB-10	5-1/2	9-1/2	CTC-8T1543	460.28
STEERING							
	8J9912		P-UB-10	2-3/8	4	CTC-8T1389	47.61
SUSPENSION FRONT							
	4T4756		I,P-U-3	9	10-3/4	CTC-1137463	1884.15
SUSPENSION REAR							
	8J8865		I,P-U-13	9	10-1/2	CTC-1137482	357.02
	84A1284-; 4YC1-						
	8J8865		I-SP-1	9	10-1/2	CTC-9T3972K	477.26
	84A1-84A1283						
	8J8865		I-SP-1	9	10-1/2	CTC-8J8902K	477.26
<b>MODEL 777C</b>							
HOIST							
	8J8924		I-UB-10	5-1/2	9-1/2	CTC-8T1543	460.28
STEERING							
	8J9912		P-UB-10	2-3/8	4	CTC-8T1389	47.61
SUSPENSION FRONT							
	4T4756		I,P-U-3	9	10-3/4	CTC-1137463	1884.15
SUSPENSION REAR							
			P-UB-1	9	10-1/2	CTC-2959885	263.81
	8J8865		I,P-U-13	9	10-1/2	CTC-1137482	357.02
<b>MODEL 777D</b>							
HOIST							
			I-UB-10	5-1/2	9-1/2	CTC-3170942	387.15
	8J8924		I-UB-10	5-1/2	9-1/2	CTC-8T1543	460.28
STEERING							
	1052440		I-UB-10	2-1/2	3-1/2	CTC-3E3299	134.08
	8J9912		P-UB-10	2-3/8	4	CTC-8T1389	47.61
SUSPENSION FRONT							
	4T4756		I,P-U-3	9	10-3/4	CTC-1137463	1884.15
SUSPENSION REAR							
			P-UB-1	9	10-1/2	CTC-2959885	263.81
	8J8865		I,P-U-13	9	10-1/2	CTC-1137482	357.02
<b>MODEL 777F</b>							
HOIST							
			I-UB-10	5-1/2	7-1/2	CTC-2950145	274.53
STEERING							
			P-UB-10	2-1/2	3-1/2	CTC-2949583	70.16
SUSPENSION FRONT							
			P-UB-1	9	10-3/4	CTC-3087849	1677.60
SUSPENSION REAR							
			P-U-1	9	10-1/2	CTC-2976849	392.20

CATERPILLAR®



## REPLACEMENT KITS FOR CATERPILLAR® EQUIPMENT

Off-Highway Trucks							
APPLICATION	CYL #	Misc-Parts, Instructions, etc.	CODE	ROD	BORE	KIT #	List \$
<b>MODEL 783B</b>							
HOIST							
		Includes extra parts	I-SP-10, 3	7-1/4, 10-1/2	9-1/4, 11-1/2	CTC-0715438	736.15
			I-SP-10, 3	7-1/4, 10-1/2	9-1/4, 11-1/2	CTC-8T4939	773.20
STEERING							
			P-UB-10	2-1/2	5	CTC-1304012	191.35
		Serial# 8GB1-316	P-UB-10	2-1/2	5	CTC-7X2658	174.24
SUSPENSION FRONT							
		Insert wiper kit	I-U-3	11	13-1/8	CTC-0711436	1200.82
		Press-in wiper kit	P-U-3	11	13-1/8	CTC-0712436	1283.68
		Combination kit	I,P-U-3	11	13-1/8	CTC-1137476	1604.66
UNSPECIFIED APPLICATION							
	4T5931		I-SP-10, 3	7-1/4, 10-1/2	9-1/4, 11-1/2	CTC-8T4939	773.20
<b>MODEL 784B, 784C</b>							
STEERING							
	6E5857		P-UB-10	2-1/2	5	CTC-1304012	191.35
<b>MODEL 785, 785B, 785C</b>							
HOIST							
		Includes extra parts	I-SP-10, 3	7-1/4, 10-1/2	9-1/4, 11-1/2	CTC-0715438	736.15
			I-SP-10, 3	7-1/4, 10-1/2	9-1/4, 11-1/2	CTC-8T4939	773.20
STEERING							
			P-UB-10	2-1/2	5	CTC-1304012	191.35
			P-UB-10	2-1/2	5	CTC-7X2658	174.24
SUSPENSION FRONT							
		Insert wiper kit	I-U-3	11	13-1/8	CTC-0711436	1200.82
		Press-in wiper kit	P-U-3	11	13-1/8	CTC-0712436	1283.68
		Combination kit	I,P-U-3	11	13-1/8	CTC-1137476	1604.66
UNSPECIFIED APPLICATION							
	4T5931	785C	I-SP-10, 3	7-1/4, 10-1/2	9-1/4, 11-1/2	CTC-8T4939	773.20
<b>MODEL 786</b>							
STEERING							
	7J9718		P-UB-10	2-1/4	5	CTC-7X2729	162.34
	7J9984		P-UB-10	2-1/4	5	CTC-7X2729	162.34
TILT LH							
	7J9762		P-UB-10	2-3/4	6-1/2	CTC-7X2689	161.01
TILT RH							
	7J9761		P-UB-10	2-3/4	6-1/2	CTC-7X2689	161.01
<b>MODEL 787B</b>							
STEERING							
	4T6797		P-UB-10	2-3/4	6	CTC-1363337	77.95
SUSPENSION							
	1061801		I,P-U-3	12-1/2	14-1/4	CTC-1137480	907.36
UNSPECIFIED APPLICATION							
	9T2807		I-SP-10, 3	7-1/4, 11	9-1/2, 12-1/4	CTC-8C5788	1056.94
<b>MODEL 789, 789B, 789C</b>							
HOIST							
			I-SP-10, 3	7-1/4, 11	9-1/2, 12-1/4	CTC-0716439	752.82
		Includes rod wear rings	I-SP-10, 3	7-1/4, 11	9-1/2, 12-1/4	CTC-8C5788	1056.94
STEERING							
			P-UB-10	2-3/4	6	CTC-2440953	102.45
SUSPENSION FRONT							
		Insert wiper kit	I-U-3	12-1/2	15-1/8	CTC-0717440	1735.90
		Press-in wiper kit	P-U-3	12-1/2	15-1/8	CTC-0718440	1735.66
		Combination kit	I,P-U-3	12-1/2	15-1/8	CTC-1131073	1951.90

**CATERPILLAR®**



## REPLACEMENT KITS FOR CATERPILLAR® EQUIPMENT

Off-Highway Trucks							
APPLICATION	CYL #	Misc-Parts, Instructions, etc.	CODE	ROD	BORE	KIT #	List \$
<b>MODEL 789, 789B, 789C</b>							
SUSPENSION REAR							
		Head# 4T4761	I-U-3	12-1/2	14-1/4	CTC-0719441	731.23
		Head# 1060904, 1061807, 1591977	P-U-3	12-1/2	14-1/4	CTC-0720441	600.86
		Head# 4T4761, 1060904, 1061807, 1591977	I,P-U-3	12-1/2	14-1/4	CTC-1137480	907.36
UNSPECIFIED APPLICATION							
	1061801	789C	I,P-U-3	12-1/2	14-1/4	CTC-1137480	907.36
	4T4844	789B, 789C	I,P-U-3	12-1/2	14-1/4	CTC-1137480	907.36
	9T2807	789C	I-SP-10, 3	7-1/4, 11	9-1/2, 12-1/4	CTC-8C5788	1056.94
<b>MODEL 793, 793B</b>							
HOIST							
			I-SP-10, 3	8-3/4, 12-1/2	11, 13-3/4	CTC-1125343	862.58
STEERING							
			P-UB-10	2-3/4	5-1/2	CTC-2601518	123.02
SUSPENSION FRONT							
		Combination kit	I,P-U-3	13-1/2	16-1/8	CTC-1137472	1928.72
		Insert wiper kit	I-U-3	13-1/2	16-1/8	CTC-7751023	1698.32
		Press-in wiper kit	P-U-3	13-1/2	16-1/8	CTC-7761023	1671.99
SUSPENSION REAR							
		Head# 4T4761	I-U-3	12-1/2	14-1/4	CTC-0719441	731.23
		Head# 1060904, 1061807, 1591977	P-U-3	12-1/2	14-1/4	CTC-0720441	600.86
		Head# 1946859; kit includes rod wear ring	P-U-3	12-1/2	14-1/4	CTC-0778441	1644.85
		Head# 4T4761, 1060904, 1061807, 1591977	I,P-U-3	12-1/2	14-1/4	CTC-1137480	907.36
<b>MODEL 793C</b>							
HOIST							
			I-SP-10, 3	7-3/4, 11-1/2	10, 12-1/2	CTC-1531282	684.69
STEERING							
			P-UB-10	2-3/4	5-1/2	CTC-2601518	123.02
SUSPENSION FRONT							
		Combination kit	I,P-U-3	13-1/2	16-1/8	CTC-1137472	1928.72
		Insert wiper kit	I-U-3	13-1/2	16-1/8	CTC-7751023	1698.32
		Press-in wiper kit	P-U-3	13-1/2	16-1/8	CTC-7761023	1671.99
SUSPENSION REAR							
		Head# 4T4761	I-U-3	12-1/2	14-1/4	CTC-0719441	731.23
		Head# 1060904, 1061807, 1591977	P-U-3	12-1/2	14-1/4	CTC-0720441	600.86
		Head# 4T4761, 1060904, 1061807, 1591977	I,P-U-3	12-1/2	14-1/4	CTC-1137480	907.36
UNSPECIFIED APPLICATION							
	6E1101		I,P-U-3	12-1/2	14-1/4	CTC-1137480	907.36
<b>MODEL 793D</b>							
HOIST							
		FDB1-UP					
	1212071		I-SP-10, 3	7-3/4, 11-1/2	10, 12-1/2	CTC-1531282	684.69
STEERING							
		FDB155-UP					
	9T8912		P-UB-10	2-3/4	5-1/2	CTC-1570287	148.64
		FDB1-UP					
	9T8912		P-UB-10	2-3/4	5-1/2	CTC-1937639	120.11
SUSPENSION FRONT							
		FDB1-UP					
	2848014		P-U-1	13-1/2		CTC-2848014K	2403.37
	2848015		P-U-1	13-1/2		CTC-2848015K	2403.37
SUSPENSION REAR							
		FDB1-UP					
	2848016		P-U-1	12-1/2		CTC-2848016K	1186.73
	2848017		P-U-1	12-1/2		CTC-2848017K	1186.25

CATERPILLAR®



## REPLACEMENT KITS FOR CATERPILLAR® EQUIPMENT

**CATERPILLAR®**

<b>Pipelayers</b>							
APPLICATION	CYL #	Misc-Parts, Instructions, etc.	CODE	ROD	BORE	KIT #	List \$
<b>MODEL 561B</b>							
COUNTERWEIGHT LH							
	3G3504		P-UB-10	2	4-1/2	CTC-7X2768	88.67
COUNTERWEIGHT RH							
	3G3505		P-UB-10	2	4-1/2	CTC-7X2768	88.67
<b>MODEL 561C, 561D</b>							
COUNTERWEIGHT LH							
	3G3504		P-UB-10	2	4-1/2	CTC-7X2768	88.67
COUNTERWEIGHT RH							
	3G3505		P-UB-10	2	4-1/2	CTC-7X2768	88.67
TRACK ADJUSTER							
			TRK ADJ			CTC-FIG4400	48.04
<b>MODEL 571A, 571F, 571G</b>							
TRACK ADJUSTER							
			TRK ADJ			CTC-FIG3401	55.84
<b>MODEL 572C, 572D, 572E, 572F</b>							
TRACK ADJUSTER							
			TRK ADJ			CTC-FIG3401	55.84
<b>MODEL 572G</b>							
DOZER LIFT LH							
	1U2136		P-UB-10	2-1/2	4-3/4	CTC-7X2660	179.61
DOZER LIFT RH							
	1U2135		P-UB-10	2-1/2	4-3/4	CTC-7X2660	179.61
TRACK ADJUSTER							
			TRK ADJ			CTC-FIG3401	55.84
<b>MODEL 578</b>							
COUNTERWEIGHT							
	3G2918		P-V-10	2	4-1/2	CTC-7X2700	70.97
	9T0489		P-V-10	2	4-1/2	CTC-7X2700	70.97
<b>MODEL 583H, 583K</b>							
SIDE DUMP							
	8J5670		P-UB-10	2	4	CTC-7X2755	147.15
	8J5670		P-UB-10	2	4	CTC-7X7937	160.47
TRACK ADJUSTER							
			TRK ADJ			CTC-FIG1401	114.41
			TRK ADJ			CTC-FIG1402	127.56
<b>MODEL 583R</b>							
COUNTERWEIGHT							
	1333850		P-UB-10	2-1/8	4	CTC-1305923	158.53
<b>MODEL 589</b>							
COUNTERWEIGHT							
	3G2918		P-V-10	2	4-1/2	CTC-7X2700	70.97
<b>MODEL 591</b>							
COUNTERWEIGHT							
	3G9729		P-V-10	2	4-1/2	CTC-7X2700	70.97
<b>MODEL 594, 594H</b>							
LIFT							
	6J0416		P-V-10	2	5	CTC-7X2763	135.46
TRACK ADJUSTER							
			TRK ADJ			CTC-FIG0401	103.67
			TRK ADJ			CTC-FIG0402	122.15
<b>MODEL MD7, MD8, MDW8</b>							
COUNTERWEIGHT							
	3G3505		P-UB-10	2	4-1/2	CTC-7X2768	88.67
<b>Scrapers</b>							
APPLICATION	CYL #	Misc-Parts, Instructions, etc.	CODE	ROD	BORE	KIT #	List \$
<b>MODEL 611</b>							
BOWL							
	3G5679		P-UB-10	2-1/4	5	CTC-9X6392	160.01



## REPLACEMENT KITS FOR CATERPILLAR® EQUIPMENT

<b>Scrapers</b>							
APPLICATION	CYL #	Misc-Parts, Instructions, etc.	CODE	ROD	BORE	KIT #	List \$
<b>MODEL 611</b>							
LOAD	3G7274		P-UB-10	2-1/4	4-3/4	CTC-1318778	140.11
STEERING	6E3566		P-UB-10	2-1/4	4-1/2	CTC-1354392	140.37
<b>MODEL 613</b>							
BOWL LIFT	7J6058		P-UB-10	2	4	CTC-7X2755	147.15
EJECTOR	1U2012		P-UB-10	2-1/4	3-1/2	CTC-7X2818	90.21
FLOOR	7J5528		P-UB-10	2-1/2	5	CTC-7X2675	124.26
STEERING	7J6054		P-UB-10	2	4	CTC-7X2755	147.15
<b>MODEL 613B</b>							
BOWL LIFT	7J6058		P-UB-10	2	4	CTC-7X2755	147.15
EJECTOR	1U2012		P-UB-10	2-1/4	3-1/2	CTC-7X2818	90.21
FLOOR	7J5528		P-UB-10	2-1/2	5	CTC-7X2675	124.26
STEERING	1U2291		P-UB-10	2	4	CTC-1328816	92.75
	6E2968		P-UB-10	2	3-1/2	CTC-7X2783	102.97
	7J6054		P-UB-10	2	4	CTC-7X2755	147.15
	9T7900		P-UB-10	2	4	CTC-1328816	92.75
<b>MODEL 613C</b>							
BOWL LIFT	1U3124		P-UB-10	2	4	CTC-7X2789	102.01
EJECTOR	1U2012		P-UB-10	2-1/4	3-1/2	CTC-7X2818	90.21
FLOOR	1U2157		P-UB-10	2-1/2	5	CTC-7X2658	174.24
STEERING	1U2291		P-UB-10	2	4	CTC-7X2789	102.01
<b>MODEL 613SC</b>							
BOWL	1U3124		P-UB-10	2	4	CTC-1328816	92.75
	3G5679		P-UB-10	2-1/4	5	CTC-9X6392	160.01
	7J6058		P-UB-10	2	4	CTC-7X2755	147.15
	9T8252		P-UB-10	2	4	CTC-1328816	92.75
EJECTOR	1U2012		P-UB-10	2-1/4	3-1/2	CTC-1358166	171.50
FLOOR	1U2157		P-UB-10	2-1/2	5	CTC-1315118	177.89
<b>MODEL 615</b>							
BOWL	3G5679		P-UB-10	2-1/4	5	CTC-9X6392	160.01
CUSHION HITCH	3G7274		P-UB-10	2-1/4	4-3/4	CTC-8T2216	78.66
DOOR	3G3883		P-UB-10	2-3/4	5-1/2	CTC-7X2690	99.55
EJECTOR	3G3892		P-UB-10	2-1/2	4-1/4	CTC-7X2663	49.39
LOAD	3G7274		P-UB-10	2-1/4	4-3/4	CTC-1318778	140.11
STEERING	5J1326		P-UB-10	2-1/4	5	CTC-7X2729	162.34

**CATERPILLAR®**



## REPLACEMENT KITS FOR CATERPILLAR® EQUIPMENT

<b>Scrapers</b>							
APPLICATION	CYL #	Misc-Parts, Instructions, etc.	CODE	ROD	BORE	KIT #	List \$
<b>MODEL 615C</b>							
<b>BOWL LIFT</b>							
	3G5679		P-UB-10	2-1/4	5	CTC-7X2729	162.34
<b>DOOR</b>							
	3G3883		P-UB-10	2-3/4	5-1/2	CTC-7X2690	99.55
<b>EJECTOR</b>							
	3G3892		P-UB-10	2-1/2	4-1/4	CTC-7X2663	49.39
<b>LIFT</b>							
	7J9902		P-UB-10	2	4-1/4	CTC-7X2819	105.12
<b>LOAD</b>							
	3G7274		P-UB-10	2-1/4	4-3/4	CTC-1318778	140.11
<b>STEERING</b>							
	5J1326		P-UB-10	2-1/4	5	CTC-7X2729	162.34
	6E2968		P-UB-10	2	3-1/2	CTC-7X2783	102.97
	6E3566		P-UB-10	2-1/4	4-1/2	CTC-1354392	140.37
<b>MODEL 615SC</b>							
<b>BOWL</b>							
	3G5679		P-UB-10	2-1/4	5	CTC-7X2729	162.34
	3G5679		P-UB-10	2-1/4	5	CTC-9X6392	160.01
<b>EJECTOR</b>							
	3G3892		P-UB-10	2-1/2	4-1/4	CTC-7X2663	49.39
<b>STEERING</b>							
	5J1326		P-UB-10	2-1/4	5	CTC-7X2729	162.34
<b>MODEL 621</b>							
<b>APRON</b>							
	5J0778		P-UB-10	2-3/4	7-1/4	CTC-7X2681	113.59
<b>BOWL LH</b>							
	5J2450		P-UB-10	2-1/2	6	CTC-7X2662	171.28
<b>BOWL RH</b>							
	5J2449		P-UB-10	2-1/2	6	CTC-7X2662	171.28
<b>EJECTOR</b>							
	1U0408		P-UB-10	4	6-1/2	CTC-7X2765	235.71
	6J9689		P-UB-10	4	6-1/2	CTC-7X2765	235.71
<b>FLOOR</b>							
	7J5528		P-UB-10	2-1/2	5	CTC-7X2675	124.26
<b>LOAD</b>							
	8J0204		P-UB-10	2-1/2	5-1/2	CTC-9X2050	100.69
<b>LOAD CUSHION HITCH</b>							
	8J0204		P-UB-10	2-1/2	5-1/2	CTC-8T1374	93.39
	9J0537		P-UB-10	2-1/2	6-1/2	CTC-8T1376	79.55
	9T1803		P-UB-10	2-1/2	5-1/2	CTC-7X2653	162.45
<b>STEERING</b>							
	5J1326		P-UB-10	2-1/4	5	CTC-7X2729	162.34
<b>MODEL 621B</b>							
<b>APRON</b>							
	5J0778		P-UB-10	2-3/4	7-1/4	CTC-7X2681	113.59
<b>BOWL LIFT</b>							
	5J2449		P-UB-10	2-1/2	6	CTC-7X2662	171.28
	5J2450		P-UB-10	2-1/2	6	CTC-7X2662	171.28
<b>EJECTOR</b>							
	1U0408		P-UB-10	4	6-1/2	CTC-7X2765	235.71
	6J9573		P-UB-10	4	6-1/2	CTC-7X2765	235.71
<b>LOAD</b>							
	8J9446		P-UB-10	2-1/2	5-1/2	CTC-7X2653	162.45
	8J9446		P-UB-10	2-1/2	5-1/2	CTC-8T1374	93.39
	8J9446		P-UB-10	2-1/2	5-1/2	CTC-9X2050	100.69

CATERPILLAR®





## REPLACEMENT KITS FOR CATERPILLAR® EQUIPMENT

<b>Scrapers</b>							
APPLICATION	CYL #	Misc-Parts, Instructions, etc.	CODE	ROD	BORE	KIT #	List \$
<b>MODEL 621B</b>							
STEERING							
	3G5192	1.11" wide wear ring, rod bearing incl	P-UB-10	2-1/2	5	CTC-1304012	191.35
	3G5192	1.55" wide wear ring	P-UB-10	2-1/2	5	CTC-7X2743	112.35
	5J1326		P-UB-10	2-1/4	5	CTC-7X2729	162.34
	8J7376		P-UB-10	2-1/2	5	CTC-1315106	168.91
<b>MODEL 621E</b>							
APRON							
	5J0778		P-UB-10	2-3/4	7-1/4	CTC-7X2681	113.59
BOWL LIFT							
	5J2449		P-UB-10	2-1/2	6	CTC-7X2662	171.28
	5J2450		P-UB-10	2-1/2	6	CTC-7X2662	171.28
EJECTOR							
	1U0408		P-UB-10	4	6-1/2	CTC-7X2765	235.71
	9T4885		P-UB-10	4	6-1/2	CTC-7X2765	235.71
LOAD							
	1083592		P-UB-10	2-1/2	5-1/2	CTC-7X2653	162.45
	9T1803		P-UB-10	2-1/2	5-1/2	CTC-7X2653	162.45
	9T1803		P-UB-10	2-1/2	5-1/2	CTC-8T1374	93.39
STEERING							
	3G5192	1.55" wide wear ring, rod bearing incl	P-UB-10	2-1/2	5	CTC-7X2658	174.24
	4T9364		P-UB-10	2-1/4	5	CTC-7X2729	162.34
	5J1326		P-UB-10	2-1/4	5	CTC-7X2729	162.34
<b>MODEL 621F</b>							
LOAD							
	1083592		P-UB-10	2-1/2	5-1/2	CTC-7X2653	162.45
STEERING							
	3G5192	1.11" wide wear ring, rod bearing incl	P-UB-10	2-1/2	5	CTC-1304012	191.35
	5J1326		P-UB-10	2-1/4	5	CTC-7X2729	162.34
<b>MODEL 621G</b>							
LOAD							
	1083592		P-UB-10	2-1/2	5-1/2	CTC-7X2653	162.45
<b>MODEL 621R</b>							
STEERING							
	3G5192	1.11" wide wear ring, rod bearing incl	P-UB-10	2-1/2	5	CTC-1304012	191.35
	3G5192	1.55" wide wear ring	P-UB-10	2-1/2	5	CTC-7X2743	112.35
<b>MODEL 621S</b>							
APRON							
	5J0778		P-UB-10	2-3/4	7-1/4	CTC-7X2681	113.59
	6E3690		P-UB-10	2-3/4	7-1/4	CTC-7X2681	113.59
BOWL LH							
	5J2450		P-UB-10	2-1/2	6	CTC-7X2662	171.28
BOWL RH							
	5J2449		P-UB-10	2-1/2	6	CTC-7X2662	171.28
EJECTOR							
	1U0408		P-UB-10	4	6-1/2	CTC-7X2765	235.71
STEERING							
	3G5192	1.11" wide wear ring, rod bearing incl	P-UB-10	2-1/2	5	CTC-1304012	191.35
<b>MODEL 621SC</b>							
APRON							
	5J0778		P-UB-10	2-3/4	7-1/4	CTC-7X2681	113.59
	6E3690		P-UB-10	2-3/4	7-1/4	CTC-7X2681	113.59
BOWL LH							
	5J2450		P-UB-10	2-1/2	6	CTC-7X2662	171.28
BOWL RH							
	5J2449		P-UB-10	2-1/2	6	CTC-7X2662	171.28

CATERPILLAR®



## REPLACEMENT KITS FOR CATERPILLAR® EQUIPMENT

<b>Scrapers</b>							
APPLICATION	CYL #	Misc-Parts, Instructions, etc.	CODE	ROD	BORE	KIT #	List \$
<b>MODEL 621SC</b>							
<b>EJECTOR</b>							
	1U0408		P-UB-10	4	6-1/2	CTC-7X2765	235.71
	6J9689		P-UB-10	4	6-1/2	CTC-7X2765	235.71
	9T4885		P-UB-10	4	6-1/2	CTC-7X2765	235.71
<b>LOAD</b>							
	8J0204		P-UB-10	2-1/2	5-1/2	CTC-9X2050	100.69
<b>STEERING</b>							
	3G5192	1.11" wide wear ring, rod bearing incl	P-UB-10	2-1/2	5	CTC-1304012	191.35
	3G5192	1.55" wide wear ring	P-UB-10	2-1/2	5	CTC-7X2743	112.35
	5J1326		P-UB-10	2-1/4	5	CTC-7X2729	162.34
<b>MODEL 623</b>							
<b>EJECTOR</b>							
	8J5478		P-UB-10	2-1/2	5	CTC-1304012	191.35
	8J5478		P-UB-10	2-1/2	5	CTC-7X2658	174.24
<b>FLOOR</b>							
	8J1821		P-UB-10	3	6	CTC-7X2698	186.32
<b>LIFT</b>							
	8J1876		P-UB-10	2-1/2	6	CTC-7X2662	171.28
<b>LOAD</b>							
	8J0204		P-UB-10	2-1/2	5-1/2	CTC-8T1374	93.39
	8J0204		P-UB-10	2-1/2	5-1/2	CTC-9X2050	100.69
	9J0537		P-UB-10	2-1/2	6-1/2	CTC-8T1376	79.55
	9T1803		P-UB-10	2-1/2	5-1/2	CTC-7X2653	162.45
<b>STEERING</b>							
	5J1326		P-UB-10	2-1/4	5	CTC-7X2729	162.34
<b>MODEL 623B</b>							
<b>BOWL LIFT</b>							
	8J1876		P-UB-10	2-1/2	6	CTC-7X2662	171.28
<b>EJECTOR</b>							
	8J5478		P-UB-10	2-1/2	5	CTC-7X2658	174.24
<b>FLOOR</b>							
	8J1821		P-UB-10	3	6	CTC-7X2698	186.32
<b>LOAD</b>							
	8J9446		P-UB-10	2-1/2	5-1/2	CTC-7X2653	162.45
	8J9446		P-UB-10	2-1/2	5-1/2	CTC-8T1374	93.39
<b>STEERING</b>							
	3G5192	1.11" wide wear ring, rod bearing incl	P-UB-10	2-1/2	5	CTC-1304012	191.35
	3G5192	1.55" wide wear ring, rod bearing incl	P-UB-10	2-1/2	5	CTC-7X2658	174.24
	3G5192	1.55" wide wear ring	P-UB-10	2-1/2	5	CTC-7X2743	112.35
	8J7376		P-UB-10	2-1/2	5	CTC-1315106	168.91
<b>WAGON DOOR</b>							
	3G4640		P-UB-10	2-1/2	6	CTC-7X2669	233.76
<b>MODEL 623E</b>							
<b>BOWL LIFT</b>							
	8J1876		P-UB-10	2-1/2	6	CTC-7X2662	171.28
<b>EJECTOR</b>							
	8J5478		P-UB-10	2-1/2	5	CTC-7X2658	174.24
	9T4886		P-UB-10	4-1/2	6	CTC-8C6958	258.90
<b>FLOOR</b>							
	8J1821		P-UB-10	3	6	CTC-7X2698	186.32
<b>LOAD</b>							
	1083592		P-UB-10	2-1/2	5-1/2	CTC-7X2653	162.45
	9T1803		P-UB-10	2-1/2	5-1/2	CTC-7X2653	162.45
	9T1803		P-UB-10	2-1/2	5-1/2	CTC-8T1374	93.39
<b>STEERING</b>							
	3G5192	1.55" wide wear ring, rod bearing incl	P-UB-10	2-1/2	5	CTC-7X2658	174.24



## REPLACEMENT KITS FOR CATERPILLAR® EQUIPMENT

<b>Scrapers</b>							
APPLICATION	CYL #	Misc-Parts, Instructions, etc.	CODE	ROD	BORE	KIT #	List \$
<b>MODEL 623F, 623G</b>							
LOAD							
	1083592		P-UB-10	2-1/2	5-1/2	CTC-7X2653	162.45
<b>MODEL 623SC</b>							
EJECTOR							
	8J5478		P-UB-10	2-1/2	5	CTC-1304012	191.35
	8J5478		P-UB-10	2-1/2	5	CTC-7X2658	174.24
FLOOR							
	8J1821		P-UB-10	3	6	CTC-7X2698	186.32
LIFT							
	8J1876		P-UB-10	2-1/2	6	CTC-7X2662	171.28
LOAD							
	8J0204		P-UB-10	2-1/2	5-1/2	CTC-9X2050	100.69
STEERING							
	3G5192	1.11" wide wear ring, rod bearing incl	P-UB-10	2-1/2	5	CTC-1304012	191.35
	3G5192	1.55" wide wear ring	P-UB-10	2-1/2	5	CTC-7X2743	112.35
	5J1326		P-UB-10	2-1/4	5	CTC-7X2729	162.34
<b>MODEL 623SCG</b>							
EJECTOR							
	8J5478		P-UB-10	2-1/2	5	CTC-1304012	191.35
LIFT							
	8J1876		P-UB-10	2-1/2	6	CTC-7X2662	171.28
STEERING							
	3G5192	1.11" wide wear ring, rod bearing incl	P-UB-10	2-1/2	5	CTC-1304012	191.35
<b>MODEL 627</b>							
APRON							
	5J0778		P-UB-10	2-3/4	7-1/4	CTC-7X2681	113.59
BAIL							
	4T5638		P-UB-10	1-3/4	3	CTC-7X2791	88.60
	8J6064		P-U-10	2	3-1/2	CTC-7X2806	121.33
BOWL LH							
	5J2450	Incl. Buffer & Rod Brg - Wear Ring 1.74"	P-UB-10	2-1/2	6	CTC-7X2662	171.28
BOWL LIFT							
	5J2449	Piston # C9J8047 - Wear Ring 1.74"	P-V-10	2-1/2	6	CTC-0514131	122.55
	5J2449	Piston # C5J0968 - Wear Ring 1.31"	P-UB-10	2-1/2	6	CTC-7X2679	138.16
	5J2450	Piston # C9J8047 - Wear Ring 1.74"	P-V-10	2-1/2	6	CTC-0514131	122.55
	5J2450	Piston # C9J8047 - Wear Ring 1.31"	P-UB-10	2-1/2	6	CTC-7X2679	138.16
BOWL RH							
	5J2449	Incl. Buffer & Rod Brg - Wear Ring 1.74"	P-UB-10	2-1/2	6	CTC-7X2662	171.28
EJECTOR							
	1U0408		P-UB-10	4	6-1/2	CTC-7X2765	235.71
LOAD							
	8J0204		P-UB-10	2-1/2	5-1/2	CTC-9X2050	100.69
LOAD CUSHION HITCH							
	8J0204		P-UB-10	2-1/2	5-1/2	CTC-8T1374	93.39
	9J0537		P-UB-10	2-1/2	6-1/2	CTC-8T1376	79.55
	9T1803		P-UB-10	2-1/2	5-1/2	CTC-7X2653	162.45
STEERING							
	5J1326		P-UB-10	2-1/4	5	CTC-7X2729	162.34
<b>MODEL 627B</b>							
APRON							
	5J0778		P-UB-10	2-3/4	7-1/4	CTC-7X2681	113.59
BAIL							
	8J6064		P-U-10	2	3-1/2	CTC-7X2806	121.33
	8J8458		P-UB-10	1-1/2	3-1/2	CTC-7X2752	95.40

**CATERPILLAR®**



## REPLACEMENT KITS FOR CATERPILLAR® EQUIPMENT

<b>Scrapers</b>							
APPLICATION	CYL #	Misc-Parts, Instructions, etc.	CODE	ROD	BORE	KIT #	List \$
<b>MODEL 627B</b>							
<b>BOWL LIFT</b>							
5J2449		Piston # C9J8047 - Wear Ring 1.74"	P-V-10	2-1/2	6	CTC-0514131	122.55
5J2449		Incl. Buffer & Rod Brg - Wear Ring 1.74"	P-UB-10	2-1/2	6	CTC-7X2662	171.28
5J2449		Piston # C5J0968 - Wear Ring 1.31"	P-UB-10	2-1/2	6	CTC-7X2679	138.16
5J2450		Piston # C9J8047 - Wear Ring 1.74"	P-V-10	2-1/2	6	CTC-0514131	122.55
5J2450		Incl. Buffer & Rod Brg - Wear Ring 1.74"	P-UB-10	2-1/2	6	CTC-7X2662	171.28
5J2450		Piston # C9J8047 - Wear Ring 1.31"	P-UB-10	2-1/2	6	CTC-7X2679	138.16
<b>EJECTOR</b>							
1U0408			P-UB-10	4	6-1/2	CTC-7X2765	235.71
6J9573			P-UB-10	4	6-1/2	CTC-7X2765	235.71
<b>LOAD</b>							
8J9446			P-UB-10	2-1/2	5-1/2	CTC-7X2653	162.45
8J9446			P-UB-10	2-1/2	5-1/2	CTC-8T1374	93.39
<b>STEERING</b>							
3G5192		1.11" wide wear ring, rod bearing incl	P-UB-10	2-1/2	5	CTC-1304012	191.35
3G5192		1.55" wide wear ring, rod bearing incl	P-UB-10	2-1/2	5	CTC-7X2658	174.24
3G5192		1.55" wide wear ring	P-UB-10	2-1/2	5	CTC-7X2743	112.35
5J1326			P-UB-10	2-1/4	5	CTC-7X2729	162.34
8J7376			P-UB-10	2-1/2	5	CTC-1315106	168.91
<b>MODEL 627E</b>							
<b>APRON</b>							
5J0778			P-UB-10	2-3/4	7-1/4	CTC-7X2681	113.59
<b>BAIL</b>							
4T5638			P-UB-10	1-3/4	3	CTC-7X2791	88.60
<b>BOWL LIFT</b>							
5J2449		Wear Ring 1.74"	P-UB-10	2-1/2	6	CTC-7X2662	171.28
5J2450		Wear Ring 1.74"	P-UB-10	2-1/2	6	CTC-7X2662	171.28
<b>EJECTOR</b>							
1U0408			P-UB-10	4	6-1/2	CTC-7X2765	235.71
9T4885			P-UB-10	4	6-1/2	CTC-7X2765	235.71
<b>LOAD</b>							
1083592			P-UB-10	2-1/2	5-1/2	CTC-7X2653	162.45
9T1803			P-UB-10	2-1/2	5-1/2	CTC-7X2653	162.45
9T1803			P-UB-10	2-1/2	5-1/2	CTC-8T1374	93.39
<b>STEERING</b>							
3G5192		1.55" wide wear ring, rod bearing incl	P-UB-10	2-1/2	5	CTC-7X2658	174.24
3G6904			P-UB-10	2-1/2	5	CTC-7X2658	174.24
5J1326			P-UB-10	2-1/4	5	CTC-7X2729	162.34
<b>MODEL 627F</b>							
<b>BAIL</b>							
6E0801			P-UB-10	1-3/4	3	CTC-7X2825	53.69
<b>BOWL LIFT</b>							
5J2449		Wear Ring 1.74"	P-UB-10	2-1/2	6	CTC-7X2662	171.28
5J2450		Wear Ring 1.74"	P-UB-10	2-1/2	6	CTC-7X2662	171.28
<b>LOAD</b>							
1083592			P-UB-10	2-1/2	5-1/2	CTC-7X2653	162.45
<b>MODEL 627G</b>							
<b>BOWL LIFT</b>							
5J2449		Wear Ring 1.74"	P-UB-10	2-1/2	6	CTC-7X2662	171.28
5J2450		Wear Ring 1.74"	P-UB-10	2-1/2	6	CTC-7X2662	171.28
<b>MODEL 627SC</b>							
<b>APRON</b>							
5J0778			P-UB-10	2-3/4	7-1/4	CTC-7X2681	113.59
6E3690			P-UB-10	2-3/4	7-1/4	CTC-7X2681	113.59

**CATERPILLAR®**



## REPLACEMENT KITS FOR CATERPILLAR® EQUIPMENT

Scrapers							
APPLICATION	CYL #	Misc-Parts, Instructions, etc.	CODE	ROD	BORE	KIT #	List \$
<b>MODEL 627SC</b>							
BAIL							
	7J2377		P-U-10	2	3-1/2	CTC-7X2806	121.33
	8J6064		P-U-10	2	3-1/2	CTC-7X2806	121.33
BOWL LH							
	5J2450		P-UB-10	2-1/2	6	CTC-7X2662	171.28
BOWL RH							
	5J2449		P-UB-10	2-1/2	6	CTC-7X2662	171.28
EJECTOR							
	1U0408		P-UB-10	4	6-1/2	CTC-7X2765	235.71
	9T4885		P-UB-10	4	6-1/2	CTC-7X2765	235.71
LOAD							
	8J0204		P-UB-10	2-1/2	5-1/2	CTC-9X2050	100.69
STEERING							
	3G5192	1.11" wide wear ring, rod bearing incl	P-UB-10	2-1/2	5	CTC-1304012	191.35
	3G5192	1.55" wide wear ring, rod bearing incl	P-UB-10	2-1/2	5	CTC-7X2658	174.24
	3G5192	1.55" wide wear ring	P-UB-10	2-1/2	5	CTC-7X2743	112.35
	5J1326		P-UB-10	2-1/4	5	CTC-7X2729	162.34
<b>MODEL 630</b>							
TRACTION CONTROL							
	4D0470		P-V-10	2	5	CTC-7X2763	135.46
	4D5543		P-V-10	2	5	CTC-7X2763	135.46
<b>MODEL 630B</b>							
BOWL							
	6J1983		P-UB-10	3	8-1/4	CTC-7X2695	355.45
EJECTOR							
	6J1419		I-U-10	6	8-1/4	CTC-1180672	654.76
	6J1419		P-V-10	6	8-1/4	CTC-8T1415	295.84
<b>MODEL 630SC</b>							
EJECTOR							
	6J1419		I-U-10	6	8-1/4	CTC-1180672	654.76
<b>MODEL 631</b>							
APRON							
	8J5931		P-UB-10	3	8-1/4	CTC-7X2695	355.45
LIFT RH							
	7J2395		P-UB-10	2-3/4	7-1/4	CTC-7X2687	266.41
LOAD							
	8J9959		P-UB-10	2-1/2	6-1/2	CTC-8T1376	79.55
<b>MODEL 631B</b>							
BOWL LIFT							
	3G9677		P-UB-10	2-3/4	7-1/4	CTC-7X2687	266.41
	7J2395		P-UB-10	2-3/4	7-1/4	CTC-7X2687	266.41
	7J2396		P-UB-10	2-3/4	7-1/4	CTC-7X2687	266.41
EJECTOR							
	6J1419		I-U-10	6	8-1/4	CTC-1180672	654.76
	6J1419		P-V-10	6	8-1/4	CTC-8T1415	295.84
LIFT							
	3G9677		P-UB-10	2-3/4	7-1/4	CTC-7X2687	266.41
LOAD CUSHION HITCH							
	9J0537		P-UB-10	2-1/2	6-1/2	CTC-8T1376	79.55
STEERING							
	3J9031		P-UB-10	2-1/2	6-1/2	CTC-8T1376	79.55
	5J1250		P-UB-10	2-1/2	6-1/2	CTC-8T1376	79.55
	5J7806		P-UB-10	2-1/2	6-1/2	CTC-8T1376	79.55
	5J8606		P-UB-10	2-1/2	6-1/2	CTC-1370264	175.56
	8J3544		P-UB-10	2-1/2	6-1/2	CTC-8T1376	79.55
STEERING RH							
	7J1693		P-UB-10	2-1/2	6-1/2	CTC-8T1376	79.55

CATERPILLAR®



## REPLACEMENT KITS FOR CATERPILLAR® EQUIPMENT

<b>Scrapers</b>							
APPLICATION	CYL #	Misc-Parts, Instructions, etc.	CODE	ROD	BORE	KIT #	List \$
<b>MODEL 631C</b>							
<b>APRON</b>							
	8J5931		P-UB-10	3	8-1/4	CTC-7X2695	355.45
<b>BOWL LIFT</b>							
	7J2395		P-UB-10	2-3/4	7-1/4	CTC-7X2687	266.41
	7J2396		P-UB-10	2-3/4	7-1/4	CTC-7X2687	266.41
<b>EJECTOR</b>							
	6J1419		I-U-10	6	8-1/4	CTC-1180672	654.76
	6J1419		P-V-10	6	8-1/4	CTC-8T1415	295.84
<b>LIFT LH</b>							
	7J2396		P-UB-10	2-3/4	7-1/4	CTC-7X2687	266.41
<b>LIFT RH</b>							
	7J2395		P-UB-10	2-3/4	7-1/4	CTC-7X2687	266.41
<b>LOAD</b>							
	7J3386		P-UB-14	2-1/2	6	CTC-7X2836	256.92
	9J0537		P-UB-10	2-1/2	6-1/2	CTC-8T1376	79.55
<b>STEERING</b>							
	5J7806		P-UB-10	2-1/2	6-1/2	CTC-8T1376	79.55
<b>MODEL 631D</b>							
<b>APRON</b>							
	8J5931		P-UB-10	3	8-1/4	CTC-7X2695	355.45
<b>EJECTOR</b>							
	6J1419		I-U-10	6	8-1/4	CTC-1180672	654.76
	6J1419		P-V-10	6	8-1/4	CTC-8T1415	295.84
	6J5824		P-V-10	6	8-1/4	CTC-8T1415	295.84
<b>LIFT LH</b>							
	9J0409		P-UB-10	2-3/4	7-1/4	CTC-7X2687	266.41
<b>LIFT RH</b>							
	9J0408		P-UB-10	2-3/4	7-1/4	CTC-7X2687	266.41
<b>LOAD</b>							
	8J9959		P-UB-10	2-1/2	6-1/2	CTC-1370264	175.56
	8J9959		P-UB-10	2-1/2	6-1/2	CTC-8T1376	79.55
<b>STEERING</b>							
	3G7607		P-UB-10	2-3/4	6-1/2	CTC-7X2689	161.01
	8J9918		P-UB-10	2-3/4	6-1/2	CTC-7X2689	161.01
<b>MODEL 631E</b>							
<b>APRON</b>							
	8J5931		P-UB-10	3	8-1/4	CTC-7X2695	355.45
<b>EJECTOR</b>							
	6E0897		P-UB-10	3	8-1/4	CTC-7X2695	355.45
	6J5824		P-V-10	6	8-1/4	CTC-8T1415	295.84
	9T3595		I-U-10	6	8-1/4	CTC-1180672	654.76
	9T3595		P-V-10	6	8-1/4	CTC-8T1415	295.84
	9T4887		I-U-10	6	8-1/4	CTC-1180672	654.76
	9T4887		P-V-10	6	8-1/4	CTC-8T1415	295.84
<b>LIFT RH</b>							
	9J0408		P-UB-10	2-3/4	7-1/4	CTC-7X2687	266.41
<b>LOAD</b>							
	8J9959		P-UB-10	2-1/2	6-1/2	CTC-1370264	175.56
	8J9959		P-UB-10	2-1/2	6-1/2	CTC-8T1376	79.55
<b>STEERING</b>							
	3G7607		P-UB-10	2-3/4	6-1/2	CTC-7X2689	161.01
	5J7806		P-UB-10	2-1/2	6-1/2	CTC-8T1376	79.55
<b>MODEL 631SC</b>							
<b>APRON</b>							
	8J5931		P-UB-10	3	8-1/4	CTC-7X2695	355.45

CATERPILLAR®



## REPLACEMENT KITS FOR CATERPILLAR® EQUIPMENT

<b>Scrapers</b>							
APPLICATION	CYL #	Misc-Parts, Instructions, etc.	CODE	ROD	BORE	KIT #	List \$
<b>MODEL 631SC</b>							
EJECTOR							
	6E0897		I-U-10	6	8-1/4	CTC-1180672	654.76
	6E0905		I-U-10	6	8-1/4	CTC-1180672	654.76
	6J1419		I-U-10	6	8-1/4	CTC-1180672	654.76
	6J5824		I-U-10	6	8-1/4	CTC-1180672	654.76
	6J5824		P-V-10	6	8-1/4	CTC-8T1415	295.84
	9T3595		I-U-10	6	8-1/4	CTC-1180672	654.76
	9T4887		I-U-10	6	8-1/4	CTC-1180672	654.76
LIFT LH							
	7J2396		P-UB-10	2-3/4	7-1/4	CTC-7X2687	266.41
	9J0409		P-UB-10	2-3/4	7-1/4	CTC-7X2687	266.41
LIFT RH							
	7J2395		P-UB-10	2-3/4	7-1/4	CTC-7X2687	266.41
	9J0408		P-UB-10	2-3/4	7-1/4	CTC-7X2687	266.41
LOAD							
	7J3386		P-UB-14	2-1/2	6	CTC-7X2836	256.92
STEERING							
	3G7607		P-UB-10	2-3/4	6-1/2	CTC-7X2689	161.01
	3J9031		P-UB-10	2-1/2	6-1/2	CTC-8T1376	79.55
	5J1250		P-UB-10	2-1/2	6-1/2	CTC-8T1376	79.55
	5J7806		P-UB-10	2-1/2	6-1/2	CTC-8T1376	79.55
<b>MODEL 632</b>							
BOWL LIFT							
	6J1983		P-UB-10	3	8-1/4	CTC-7X2695	355.45
EJECTOR							
	6J1419		I-U-10	6	8-1/4	CTC-1180672	654.76
	6J1419		P-V-10	6	8-1/4	CTC-8T1415	295.84
TRACTION CONTROL							
	4D0470		P-V-10	2	5	CTC-7X2763	135.46
	4D5543		P-V-10	2	5	CTC-7X2763	135.46
<b>MODEL 633</b>							
BOWL LIFT							
	3G9677		P-UB-10	2-3/4	7-1/4	CTC-7X2687	266.41
LIFT							
	3G9677		P-UB-10	2-3/4	7-1/4	CTC-7X2687	266.41
LOAD CUSHION HITCH							
	9J0537		P-UB-10	2-1/2	6-1/2	CTC-8T1376	79.55
STEERING							
	5J7806		P-UB-10	2-1/2	6-1/2	CTC-1370264	175.56
	5J7806		P-UB-10	2-1/2	6-1/2	CTC-8T1376	79.55
	8J3544		P-UB-10	2-1/2	6-1/2	CTC-8T1376	79.55
STEERING RH							
	7J1693		P-UB-10	2-1/2	6-1/2	CTC-8T1376	79.55
<b>MODEL 633B</b>							
BOWL LIFT							
	3G9677		P-UB-10	2-3/4	7-1/4	CTC-7X2687	266.41
LOAD CUSHION HITCH							
	9J0537		P-UB-10	2-1/2	6-1/2	CTC-8T1376	79.55
STEERING							
	5J7806		P-UB-10	2-1/2	6-1/2	CTC-8T1376	79.55
	6J1516		P-UB-10	2-1/2	6-1/2	CTC-8T1376	79.55
	8J3544		P-UB-10	2-1/2	6-1/2	CTC-8T1376	79.55
STEERING RH							
	7J1693		P-UB-10	2-1/2	6-1/2	CTC-8T1376	79.55
<b>MODEL 633C</b>							
BOWL LIFT							
	3G9677		P-UB-10	2-3/4	7-1/4	CTC-7X2687	266.41

**CATERPILLAR®**





## REPLACEMENT KITS FOR CATERPILLAR® EQUIPMENT

<b>Scrapers</b>							
APPLICATION	CYL #	Misc-Parts, Instructions, etc.	CODE	ROD	BORE	KIT #	List \$
<b>MODEL 633C</b>							
LIFT							
	3G9677		P-UB-10	2-3/4	7-1/4	CTC-7X2687	266.41
LOAD							
	7J3386		P-UB-14	2-1/2	6	CTC-7X2836	256.92
	9J0537		P-UB-10	2-1/2	6-1/2	CTC-1370264	175.56
	9J0537		P-UB-10	2-1/2	6-1/2	CTC-8T1376	79.55
STEERING							
	5J7806		P-UB-10	2-1/2	6-1/2	CTC-1370264	175.56
	5J7806		P-UB-10	2-1/2	6-1/2	CTC-8T1376	79.55
	6J1516		P-UB-10	2-1/2	6-1/2	CTC-8T1376	79.55
	8J3544		P-UB-10	2-1/2	6-1/2	CTC-1370264	175.56
	8J3544		P-UB-10	2-1/2	6-1/2	CTC-8T1376	79.55
STEERING RH							
	7J1693		P-UB-10	2-1/2	6-1/2	CTC-8T1376	79.55
<b>MODEL 633D</b>							
BOWL LIFT							
	3G9677		P-UB-10	2-3/4	7-1/4	CTC-7X2687	266.41
	7J0243		P-UB-10	2-3/4	7-1/4	CTC-7X2687	266.41
EJECTOR							
	9T3595		I-U-10	6	8-1/4	CTC-1180672	654.76
	9T3595		P-V-10	6	8-1/4	CTC-8T1415	295.84
LOAD							
	8J9959		P-UB-10	2-1/2	6-1/2	CTC-1370264	175.56
	8J9959		P-UB-10	2-1/2	6-1/2	CTC-8T1376	79.55
STEERING							
	3G7607		P-UB-10	2-3/4	6-1/2	CTC-7X2689	161.01
	6J1516		P-UB-10	2-1/2	6-1/2	CTC-8T1376	79.55
	8J9918		P-UB-10	2-3/4	6-1/2	CTC-7X2689	161.01
STEERING RH							
	7J1693		P-UB-10	2-1/2	6-1/2	CTC-8T1376	79.55
<b>MODEL 633SC</b>							
BOWL							
	1313223		P-UB-10	2-3/4	7-1/4	CTC-7X2687	266.41
EJECTOR							
	1U0408		P-UB-10	4	6-1/2	CTC-7X2765	235.71
LIFT							
	3G9677		P-UB-10	2-3/4	7-1/4	CTC-7X2687	266.41
LOAD							
	7J3386		P-UB-14	2-1/2	6	CTC-7X2836	256.92
STEERING							
	5J7806		P-UB-10	2-1/2	6-1/2	CTC-8T1376	79.55
	6J1516		P-UB-10	2-1/2	6-1/2	CTC-8T1376	79.55
	8J3544		P-UB-10	2-1/2	6-1/2	CTC-8T1376	79.55
STEERING RH							
	7J1693		P-UB-10	2-1/2	6-1/2	CTC-8T1376	79.55
<b>MODEL 637</b>							
APRON							
	8J5931		P-UB-10	3	8-1/4	CTC-7X2695	355.45
BAIL							
	4T5638		P-UB-10	1-3/4	3	CTC-7X2791	88.60
	7J2377		P-U-10	2	3-1/2	CTC-7X2806	121.33
	8J6064		P-U-10	2	3-1/2	CTC-7X2806	121.33
BOWL LIFT							
	7J2395		P-UB-10	2-3/4	7-1/4	CTC-7X2687	266.41
	7J2396		P-UB-10	2-3/4	7-1/4	CTC-7X2687	266.41

CATERPILLAR®



## REPLACEMENT KITS FOR CATERPILLAR® EQUIPMENT

<b>Scrapers</b>							
APPLICATION	CYL #	Misc-Parts, Instructions, etc.	CODE	ROD	BORE	KIT #	List \$
<b>MODEL 637</b>							
<b>EJECTOR</b>							
	6J5824		I-U-10	6	8-1/4	CTC-1180672	654.76
	6J5824		P-V-10	6	8-1/4	CTC-8T1415	295.84
<b>LIFT LH</b>							
	7J2396		P-UB-10	2-3/4	7-1/4	CTC-7X2687	266.41
<b>LIFT RH</b>							
	7J2395		P-UB-10	2-3/4	7-1/4	CTC-7X2687	266.41
<b>LOAD</b>							
	7J3386		P-UB-14	2-1/2	6	CTC-7X2836	256.92
	8J9959		P-UB-10	2-1/2	6-1/2	CTC-8T1376	79.55
	9J0537		P-UB-10	2-1/2	6-1/2	CTC-1370264	175.56
	9J0537		P-UB-10	2-1/2	6-1/2	CTC-8T1376	79.55
<b>STEERING</b>							
	5J7806		P-UB-10	2-1/2	6-1/2	CTC-1370264	175.56
	5J7806		P-UB-10	2-1/2	6-1/2	CTC-8T1376	79.55
<b>MODEL 637B</b>							
<b>APRON</b>							
	8J5931		P-UB-10	3	8-1/4	CTC-7X2695	355.45
<b>BOWL LIFT</b>							
	7J2395		P-UB-10	2-3/4	7-1/4	CTC-7X2687	266.41
	7J2396		P-UB-10	2-3/4	7-1/4	CTC-7X2687	266.41
<b>EJECTOR</b>							
	6J5824		P-V-10	6	8-1/4	CTC-8T1415	295.84
<b>MODEL 637D</b>							
<b>APRON</b>							
	8J5931		P-UB-10	3	8-1/4	CTC-7X2695	355.45
<b>BAIL</b>							
	8J6064		P-U-10	2	3-1/2	CTC-7X2806	121.33
	8J8458		P-UB-10	1-1/2	3-1/2	CTC-7X2752	95.40
<b>EJECTOR</b>							
	6J5824		P-V-10	6	8-1/4	CTC-8T1415	295.84
<b>LIFT LH</b>							
	9J0409		P-UB-10	2-3/4	7-1/4	CTC-7X2687	266.41
<b>LIFT RH</b>							
	9J0408		P-UB-10	2-3/4	7-1/4	CTC-7X2687	266.41
<b>LOAD</b>							
	8J9959		P-UB-10	2-1/2	6-1/2	CTC-1370264	175.56
	8J9959		P-UB-10	2-1/2	6-1/2	CTC-8T1376	79.55
<b>STEERING</b>							
	3G7607		P-UB-10	2-3/4	6-1/2	CTC-7X2689	161.01
	8J9918		P-UB-10	2-3/4	6-1/2	CTC-7X2689	161.01
<b>MODEL 637E</b>							
<b>APRON</b>							
	8J5931		P-UB-10	3	8-1/4	CTC-7X2695	355.45
<b>BAIL</b>							
	4T5638		P-UB-10	1-3/4	3	CTC-7X2791	88.60
<b>EJECTOR</b>							
	6J5824		P-V-10	6	8-1/4	CTC-8T1415	295.84
	9T3595		I-U-10	6	8-1/4	CTC-1180672	654.76
	9T3595		P-V-10	6	8-1/4	CTC-8T1415	295.84
	9T4887		I-U-10	6	8-1/4	CTC-1180672	654.76
	9T4887		P-V-10	6	8-1/4	CTC-8T1415	295.84
<b>LIFT LH</b>							
	9J0409		P-UB-10	2-3/4	7-1/4	CTC-7X2687	266.41
<b>LIFT RH</b>							
	9J0408		P-UB-10	2-3/4	7-1/4	CTC-7X2687	266.41

**CATERPILLAR®**



## REPLACEMENT KITS FOR CATERPILLAR® EQUIPMENT

**CATERPILLAR®**

<b>Scrapers</b>							
APPLICATION	CYL #	Misc-Parts, Instructions, etc.	CODE	ROD	BORE	KIT #	List \$
<b>MODEL 637E</b>							
LOAD							
	8J9959		P-UB-10	2-1/2	6-1/2	CTC-1370264	175.56
	8J9959		P-UB-10	2-1/2	6-1/2	CTC-8T1376	79.55
STEERING							
	3G7607		P-UB-10	2-3/4	6-1/2	CTC-7X2689	161.01
<b>MODEL 637SC</b>							
APRON							
	8J5931		P-UB-10	3	8-1/4	CTC-7X2695	355.45
BAIL							
	7J2377		P-U-10	2	3-1/2	CTC-7X2806	121.33
	8J6064		P-U-10	2	3-1/2	CTC-7X2806	121.33
EJECTOR							
	6E0897		I-U-10	6	8-1/4	CTC-1180672	654.76
	6E0905		I-U-10	6	8-1/4	CTC-1180672	654.76
	6J5824		I-U-10	6	8-1/4	CTC-1180672	654.76
	6J5824		P-V-10	6	8-1/4	CTC-8T1415	295.84
	9T3595		I-U-10	6	8-1/4	CTC-1180672	654.76
	9T4887		I-U-10	6	8-1/4	CTC-1180672	654.76
LIFT LH							
	7J2396		P-UB-10	2-3/4	7-1/4	CTC-7X2687	266.41
	9J0409		P-UB-10	2-3/4	7-1/4	CTC-7X2687	266.41
LIFT RH							
	7J2395		P-UB-10	2-3/4	7-1/4	CTC-7X2687	266.41
	9J0408		P-UB-10	2-3/4	7-1/4	CTC-7X2687	266.41
LOAD							
	7J3386		P-UB-14	2-1/2	6	CTC-7X2836	256.92
STEERING							
	3G7607		P-UB-10	2-3/4	6-1/2	CTC-7X2689	161.01
	5J7806		P-UB-10	2-1/2	6-1/2	CTC-8T1376	79.55
<b>MODEL 639D</b>							
BOWL LIFT							
	3G9677		P-UB-10	2-3/4	7-1/4	CTC-7X2687	266.41
EJECTOR							
	3G2949		P-UB-10	2-1/2	4-1/2	CTC-7X2667	95.53
LOAD							
	8J9959		P-UB-10	2-1/2	6-1/2	CTC-1370264	175.56
	8J9959		P-UB-10	2-1/2	6-1/2	CTC-8T1376	79.55
STEERING							
	3G7607		P-UB-10	2-3/4	6-1/2	CTC-7X2689	161.01
<b>MODEL 639SC</b>							
EJECTOR							
	3G2949		P-UB-10	2-1/2	4-1/2	CTC-7X2667	95.53
LIFT							
	3G9677		P-UB-10	2-3/4	7-1/4	CTC-7X2687	266.41
<b>MODEL 641, 641B</b>							
APRON							
	5J8117		P-UB-10	3-1/4	9-1/4	CTC-7X2708	203.80
BOWL LIFT							
	6J1983		P-UB-10	3	8-1/4	CTC-7X2695	355.45
BOWL LIFT LH							
	7J4364		P-UB-10	3	8-1/4	CTC-7X2695	355.45
BOWL LIFT RH							
	7J4363		P-UB-10	3	8-1/4	CTC-7X2695	355.45
CUSHION HITCH							
	7J4623		P-UB-10	3-1/2	8-1/4	CTC-7X2725	389.08



## REPLACEMENT KITS FOR CATERPILLAR® EQUIPMENT

<b>Scrapers</b>							
APPLICATION	CYL #	Misc-Parts, Instructions, etc.	CODE	ROD	BORE	KIT #	List \$
<b>MODEL 641, 641B</b>							
LOAD							
	5J8623		P-UB-10	3-1/2	8-1/4	CTC-7X2728	174.95
	7J4623	641B only	P-UB-10	3-1/2	8-1/4	CTC-7X2725	389.08
STEERING							
	3G9689		P-UB-10	2-3/4	7-1/4	CTC-7X2687	266.41
<b>MODEL 641SC</b>							
BOWL							
	6J1983		P-UB-10	3	8-1/4	CTC-7X2695	355.45
BOWL LH							
	7J4364		P-UB-10	3	8-1/4	CTC-7X2695	355.45
BOWL RH							
	7J4363		P-UB-10	3	8-1/4	CTC-7X2695	355.45
LOAD							
	5J8623		P-UB-10	3-1/2	8-1/4	CTC-7X2728	174.95
	7J4623		P-UB-10	3-1/2	8-1/4	CTC-7X2725	389.08
<b>MODEL 650, 650B</b>							
BOWL LIFT LH							
	7J4356		P-UB-10	3-1/4	9-1/4	CTC-7X2716	159.60
	7J4406		P-UB-10	3-1/4	9-1/4	CTC-7X2716	159.60
BOWL LIFT RH							
	7J4355		P-UB-10	3-1/4	9-1/4	CTC-7X2716	159.60
	7J4405		P-UB-10	3-1/4	9-1/4	CTC-7X2716	159.60
SPECIAL APPLICATION							
	4J2064	650 only	P-UB-10	2-1/2	6	CTC-7X2679	138.16
	4J9996	650 only	P-UB-10	2-1/2	7-1/4	CTC-7X2661	180.93
<b>MODEL 651</b>							
APRON							
	5J8117		P-UB-10	3-1/4	9-1/4	CTC-7X2708	203.80
BOWL LIFT LH							
	7J4398		P-UB-10	3-1/4	9-1/4	CTC-7X2716	159.60
BOWL LIFT RH							
	7J4397		P-UB-10	3-1/4	9-1/4	CTC-7X2716	159.60
CUSHION HITCH							
	7J4623		P-UB-10	3-1/2	8-1/4	CTC-7X2725	389.08
LOAD							
	3G8757		P-UB-10	3-1/2	8-1/4	CTC-7X2724	203.18
	5J8623		P-UB-10	3-1/2	8-1/4	CTC-7X2728	174.95
STEERING							
	3G9689		P-UB-10	2-3/4	7-1/4	CTC-7X2687	266.41
	4T8563		P-UB-10	3-1/4	7-1/4	CTC-7X2718	198.65
<b>MODEL 651B</b>							
APRON							
	5J8117		P-UB-10	3-1/4	9-1/4	CTC-7X2708	203.80
BOWL LIFT LH							
	7J4398		P-UB-10	3-1/4	9-1/4	CTC-7X2716	159.60
BOWL LIFT RH							
	7J4397		P-UB-10	3-1/4	9-1/4	CTC-7X2716	159.60
CUSHION HITCH							
	7J4623		P-UB-10	3-1/2	8-1/4	CTC-7X2725	389.08
LOAD							
	5J8623		P-UB-10	3-1/2	8-1/4	CTC-7X2728	174.95
	7J4623		P-UB-10	3-1/2	8-1/4	CTC-7X2725	389.08
STEERING							
	3G9689		P-UB-10	2-3/4	7-1/4	CTC-7X2687	266.41
	5J8149		P-UB-10	2-3/4	7-1/4	CTC-7X2687	266.41

**CATERPILLAR®**



## REPLACEMENT KITS FOR CATERPILLAR® EQUIPMENT

<b>Scrapers</b>							
APPLICATION	CYL #	Misc-Parts, Instructions, etc.	CODE	ROD	BORE	KIT #	List \$
<b>MODEL 651C</b>							
APRON							
	5J8117		P-UB-10	3-1/4	9-1/4	CTC-7X2708	203.80
STEERING							
	3G9689		P-UB-10	2-3/4	7-1/4	CTC-7X2687	266.41
	5J8149		P-UB-10	2-3/4	7-1/4	CTC-7X2687	266.41
<b>MODEL 651E</b>							
APRON							
	3G8621		P-UB-10	3-1/4	9-1/4	CTC-7X2708	203.80
BOWL LIFT							
	4T5735		P-UB-10	3-1/4	9-1/4	CTC-7X2716	159.60
	4T5736		P-UB-10	3-1/4	9-1/4	CTC-7X2716	159.60
CUSHION HITCH							
	3G8757		P-UB-10	3-1/2	8-1/4	CTC-7X2724	203.18
LOAD							
	3G8757		P-UB-10	3-1/2	8-1/4	CTC-7X2724	203.18
STEERING							
	3G5516		P-UB-10	3-1/4	7-1/4	CTC-7X2718	198.65
	3G9689		P-UB-10	2-3/4	7-1/4	CTC-7X2687	266.41
	4T8563		P-UB-10	3-1/4	7-1/4	CTC-7X2718	198.65
<b>MODEL 651SC</b>							
APRON							
	3G8621		P-UB-10	3-1/4	9-1/4	CTC-7X2708	203.80
BOWL							
	7J4398		P-UB-10	3-1/4	9-1/4	CTC-7X2716	159.60
BOWL LH							
	4T5735		P-UB-10	3-1/4	9-1/4	CTC-7X2716	159.60
LOAD							
	5J8623		P-UB-10	3-1/2	8-1/4	CTC-7X2728	174.95
	7J4623		P-UB-10	3-1/2	8-1/4	CTC-7X2725	389.08
STEERING							
	4T8563		P-UB-10	3-1/4	7-1/4	CTC-7X2718	198.65
<b>MODEL 657</b>							
APRON							
	5J8117		P-UB-10	3-1/4	9-1/4	CTC-7X2708	203.80
BAIL							
	4T5638		P-UB-10	1-3/4	3	CTC-7X2791	88.60
	7J2377		P-U-10	2	3-1/2	CTC-7X2806	121.33
	8J6064		P-U-10	2	3-1/2	CTC-7X2806	121.33
	8J8458		P-UB-10	1-1/2	3-1/2	CTC-7X2752	95.40
BOWL LIFT LH							
	7J4398		P-UB-10	3-1/4	9-1/4	CTC-7X2716	159.60
BOWL LIFT RH							
	7J4397		P-UB-10	3-1/4	9-1/4	CTC-7X2716	159.60
LOAD							
	3G8757		P-UB-10	3-1/2	8-1/4	CTC-7X2724	203.18
LOAD CUSHION							
	5J8623		P-UB-10	3-1/2	8-1/4	CTC-7X2725	389.08
	5J8623		P-UB-10	3-1/2	8-1/4	CTC-7X2728	174.95
	7J4623		P-UB-10	3-1/2	8-1/4	CTC-7X2725	389.08
STEERING							
	3G5516		P-UB-10	3-1/4	7-1/4	CTC-7X2718	198.65
	3G9689		P-UB-10	2-3/4	7-1/4	CTC-7X2687	266.41
	4T8563		P-UB-10	3-1/4	7-1/4	CTC-7X2718	198.65
	5J8149		P-UB-10	2-3/4	7-1/4	CTC-7X2687	266.41



## REPLACEMENT KITS FOR CATERPILLAR® EQUIPMENT

<b>Scrapers</b>							
APPLICATION	CYL #	Misc-Parts, Instructions, etc.	CODE	ROD	BORE	KIT #	List \$
<b>MODEL 657B</b>							
APRON							
	5J4354		P-UB-10	3-1/4	9-1/4	CTC-7X2708	203.80
	5J8117		P-UB-10	3-1/4	9-1/4	CTC-7X2708	203.80
BAIL							
	7J2377		P-U-10	2	3-1/2	CTC-7X2806	121.33
	8J6064		P-U-10	2	3-1/2	CTC-7X2806	121.33
	8J8458		P-UB-10	1-1/2	3-1/2	CTC-7X2752	95.40
BOWL LIFT LH							
	7J4398		P-UB-10	3-1/4	9-1/4	CTC-7X2716	159.60
BOWL LIFT RH							
	7J4397		P-UB-10	3-1/4	9-1/4	CTC-7X2716	159.60
LOAD							
	5J8623		P-UB-10	3-1/2	8-1/4	CTC-7X2728	174.95
	7J4623		P-UB-10	3-1/2	8-1/4	CTC-7X2725	389.08
LOAD CUSHION							
	5J8623		P-UB-10	3-1/2	8-1/4	CTC-7X2725	389.08
	7J4623		P-UB-10	3-1/2	8-1/4	CTC-7X2725	389.08
STEERING							
	3G9689		P-UB-10	2-3/4	7-1/4	CTC-7X2687	266.41
	5J8149		P-UB-10	2-3/4	7-1/4	CTC-7X2687	266.41
<b>MODEL 657E</b>							
APRON							
	3G8621		P-UB-10	3-1/4	9-1/4	CTC-7X2708	203.80
BAIL							
	4T5638		P-UB-10	1-3/4	3	CTC-7X2791	88.60
	8J8458		P-UB-10	1-1/2	3-1/2	CTC-7X2752	95.40
BOWL LIFT							
	4T5735		P-UB-10	3-1/4	9-1/4	CTC-7X2716	159.60
	4T5736		P-UB-10	3-1/4	9-1/4	CTC-7X2716	159.60
CUSHION HITCH							
	3G8757		P-UB-10	3-1/2	8-1/4	CTC-7X2724	203.18
EJECTOR							
	9T4886		P-UB-10	4-1/2	6	CTC-8C6958	258.90
	9T4887		I-U-10	6	8-1/4	CTC-1180672	654.76
	9T4887		P-V-10	6	8-1/4	CTC-8T1415	295.84
LOAD							
	3G8757		P-UB-10	3-1/2	8-1/4	CTC-7X2724	203.18
STEERING							
	3G5516		P-UB-10	3-1/4	7-1/4	CTC-7X2718	198.65
	4T8563		P-UB-10	3-1/4	7-1/4	CTC-7X2718	198.65
<b>MODEL 657SC</b>							
APRON							
	3G8621		P-UB-10	3-1/4	9-1/4	CTC-7X2708	203.80
	5J8117		P-UB-10	3-1/4	9-1/4	CTC-7X2708	203.80
BAIL							
	7J2377		P-U-10	2	3-1/2	CTC-7X2806	121.33
	8J6062		P-U-10	2	3-1/2	CTC-7X2806	121.33
	8J8457		P-UB-10	1-1/2	3-1/2	CTC-7X2752	95.40
BOWL							
	7J4398		P-UB-10	3-1/4	9-1/4	CTC-7X2716	159.60
BOWL LH							
	4T5735		P-UB-10	3-1/4	9-1/4	CTC-7X2716	159.60
BOWL RH							
	7J4397		P-UB-10	3-1/4	9-1/4	CTC-7X2716	159.60
LOAD							
	5J8623		P-UB-10	3-1/2	8-1/4	CTC-7X2728	174.95
	7J4623		P-UB-10	3-1/2	8-1/4	CTC-7X2725	389.08

**CATERPILLAR®**



## REPLACEMENT KITS FOR CATERPILLAR® EQUIPMENT

<b>Scrapers</b>							
APPLICATION	CYL #	Misc-Parts, Instructions, etc.	CODE	ROD	BORE	KIT #	List \$
<b>MODEL 657SC</b>							
STEERING							
	4T8563		P-UB-10	3-1/4	7-1/4	CTC-7X2718	198.65
<b>MODEL 660, 666B</b>							
BOWL LIFT LH							
	7J4356		P-UB-10	3-1/4	9-1/4	CTC-7X2716	159.60
BOWL LIFT RH							
	7J4355		P-UB-10	3-1/4	9-1/4	CTC-7X2716	159.60
SPECIAL APPLICATION							
	4J2064	660 only	P-UB-10	2-1/2	6	CTC-7X2679	138.16
<b>MODEL 660B, 666</b>							
BOWL LIFT LH							
	7J4356		P-UB-10	3-1/4	9-1/4	CTC-7X2716	159.60
	7J4406		P-UB-10	3-1/4	9-1/4	CTC-7X2716	159.60
BOWL LIFT RH							
	7J4355		P-UB-10	3-1/4	9-1/4	CTC-7X2716	159.60
	7J4405		P-UB-10	3-1/4	9-1/4	CTC-7X2716	159.60
SPECIAL APPLICATION							
	4J2064		P-UB-10	2-1/2	6	CTC-7X2679	138.16
	4J9996	666 only	P-UB-10	2-1/2	7-1/4	CTC-7X2661	180.93
<b>MODEL 660SC, 666SC</b>							
BOWL LH							
	7J4356		P-UB-10	3-1/4	9-1/4	CTC-7X2716	159.60
<b>MODEL J621</b>							
FLOOR							
	7J5528		P-UB-10	2-1/2	5	CTC-7X2675	124.26
<b>Skidders</b>							
APPLICATION	CYL #	Misc-Parts, Instructions, etc.	CODE	ROD	BORE	KIT #	List \$
<b>MODEL 508</b>							
BOOM							
	4T0863		P-UB-10	1-3/4	3-1/2	CTC-7X2784	56.35
GRAPPLE							
	4T0859		P-UB-10	2-1/4	4-1/2	CTC-7X2748	107.59
	9T5924		P-UB-10	2-1/4	4	CTC-7X2744	55.31
LIFT LH							
	4T9394		P-UB-10	1-1/2	3	CTC-7X2751	64.04
LIFT RH							
	4T0862		P-UB-10	1-1/2	3	CTC-7X2751	64.04
STEERING LH							
	4T0861		P-UB-10	1-1/2	3-1/4	CTC-7X2741	72.49
STEERING RH							
	4T0860		P-UB-10	1-1/2	3-1/4	CTC-7X2741	72.49
TONG							
	4T0859		P-UB-10	2-1/4	4-1/2	CTC-1326770	150.17
<b>MODEL 515, 525</b>							
LIFT							
	1117951		P-UB-10	2	4	CTC-1113302	118.96
	1397547		P-UB-10	2	4	CTC-1113302	118.96
<b>MODEL 517</b>							
ANGLING							
	1006174		P-UB-10	1-3/4	3-1/2	CTC-7X2784	56.35
LIFT							
	6E0365		P-UB-10	2	4-1/4	CTC-7X2819	105.12
TILT							
	9T9557		P-UB-10	2	4-1/4	CTC-1378662	135.35

CATERPILLAR®





## REPLACEMENT KITS FOR CATERPILLAR® EQUIPMENT

Skidders							
APPLICATION	CYL #	Misc-Parts, Instructions, etc.	CODE	ROD	BORE	KIT #	List \$
<b>MODEL 518</b>							
LIFT							
	7J8925		P-UB-10	2	4	CTC-1328816	92.75
	9T1773		P-UB-10	2-1/2	5	CTC-1315118	177.89
STEERING LH							
	7J3350		P-UB-10	1-3/4	3	CTC-7X2825	53.69
STEERING RH							
	7J3349		P-UB-10	1-3/4	3	CTC-7X2825	53.69
TILT LH							
	9T1777		P-UB-10	2-1/4	4-1/4	CTC-7X2750	114.40
TILT RH							
	9T1772		P-UB-10	2-1/4	4-1/4	CTC-7X2750	114.40
<b>MODEL 518C, 520D, 522C</b>							
LIFT							
	1117951		P-UB-10	2	4	CTC-1113302	118.96
	1397547		P-UB-10	2	4	CTC-1113302	118.96
	7J8925	518C & 522C only	P-UB-10	2	4	CTC-1328816	92.75
STEERING LH							
	7J3350		P-UB-10	1-3/4	3	CTC-7X2825	53.69
STEERING RH							
	7J3349		P-UB-10	1-3/4	3	CTC-7X2825	53.69
<b>MODEL 520C</b>							
LIFT							
	7J8925		P-UB-10	2	4	CTC-7X2789	102.01
STEERING RH							
	7J3349		P-UB-10	1-3/4	3	CTC-7X2791	88.60
<b>MODEL 525B</b>							
LIFT							
	1600492		P-UB-10	2-1/4	4	CTC-1546526	150.74
<b>MODEL 527</b>							
LIFT							
	1418640		P-UB-10	2-1/4	3-3/4	CTC-1361897	159.18
	1607610		P-UB-10	2-1/2	4-3/4	CTC-1328811	161.44
	6E0366		P-UB-10	2-1/2	4-3/4	CTC-1328811	161.44
<b>MODEL 528</b>							
DOZER LIFT							
	7J9902		P-UB-10	2	4-1/4	CTC-7X2819	105.12
STEERING LH							
	7J9234		P-UB-10	1-1/2	3-1/2	CTC-7X2752	95.40
	9J5856		P-UB-10	1-3/4	3-3/4	CTC-1329361	43.30
STEERING RH							
	7J9233		P-UB-10	1-1/2	3-1/2	CTC-7X2752	95.40
	9J5854		P-UB-10	1-3/4	3-3/4	CTC-1329361	43.30
<b>MODEL 528B</b>							
DOZER							
	7J9902		P-UB-10	2	4-1/4	CTC-7X2819	105.12
STEERING LH							
	9J5856		P-UB-10	1-3/4	3-3/4	CTC-1329361	43.30
STEERING RH							
	9J5854		P-UB-10	1-3/4	3-3/4	CTC-1329361	43.30
<b>MODEL 530B</b>							
DOZER							
	7J9902		P-UB-10	2	4-1/4	CTC-7X2819	105.12
LIFT							
	7J9902		P-UB-10	2	4-1/4	CTC-7X2819	105.12
STEERING							
	9J5854		P-UB-10	1-3/4	3-3/4	CTC-1329361	43.30
	9J5856		P-UB-10	1-3/4	3-3/4	CTC-1329361	43.30

CATERPILLAR®



## REPLACEMENT KITS FOR CATERPILLAR® EQUIPMENT

<b>Skidders</b>							
APPLICATION	CYL #	Misc-Parts, Instructions, etc.	CODE	ROD	BORE	KIT #	List \$
<b>MODEL 535B, 545</b>							
LIFT	1600492		P-UB-10	2-1/4	4	CTC-1546526	150.74
<b>MODEL FB508</b>							
<b>GRAPPLE</b>							
	4T0860		P-UB-10	1-1/2	3-1/4	CTC-7X2741	72.49
	4T0861		P-UB-10	1-1/2	3-1/4	CTC-7X2741	72.49
	9T5924		P-UB-10	1-1/2	3-1/4	CTC-7X2741	72.49
<b>MODEL FB518</b>							
LIFT	9T1773		P-UB-10	2-1/2	5	CTC-7X2658	174.24
<b>STEERING</b>							
	7J3349		P-UB-10	1-3/4	3	CTC-7X2791	88.60
	7J3350		P-UB-10	1-3/4	3	CTC-7X2791	88.60
TILT LH	9T1777		P-UB-10	2-1/4	4-1/4	CTC-7X2750	114.40
TILT RH	9T1772		P-UB-10	2-1/4	4-1/4	CTC-7X2750	114.40
<b>Soil Compactors</b>							
APPLICATION	CYL #	Misc-Parts, Instructions, etc.	CODE	ROD	BORE	KIT #	List \$
<b>MODEL 815</b>							
LIFT	3G0881		P-UB-10	2	4	CTC-7X2789	102.01
	8J6809		P-UB-10	2	4	CTC-7X2755	147.15
	8J8756		P-UB-10	2	4	CTC-7X2789	102.01
LIFT RH	4J7859		P-UB-10	2	4	CTC-7X2755	147.15
<b>STEERING</b>							
	4T1574		P-UB-10	2	4	CTC-1328816	92.75
	4T1574		P-UB-10	2	4	CTC-7X2789	102.01
	7J6054		P-UB-10	2	4	CTC-7X2755	147.15
STEERING LH	7J9356		P-UB-10	2	4	CTC-7X2755	147.15
STEERING RH	7J9355		P-UB-10	2	4	CTC-7X2755	147.15
TILT	1U1988		P-UB-10	2	4	CTC-7X2755	147.15
<b>MODEL 815B</b>							
LIFT	3G0881		P-UB-10	2	4	CTC-1328816	92.75
	8J6809		P-UB-10	2	4	CTC-7X2755	147.15
<b>STEERING</b>							
	4T1574		P-UB-10	2	4	CTC-1328816	92.75
	6E5024		P-UB-10	2	4	CTC-1113302	118.96
TILT	1U1988		P-UB-10	2	4	CTC-7X2755	147.15
<b>MODEL 815F</b>							
LIFT	3G0881		P-UB-10	2	4	CTC-1328816	92.75
<b>STEERING</b>							
	4T1574		P-UB-10	2	4	CTC-1328816	92.75
	6E5024		P-UB-10	2	4	CTC-1113302	118.96
<b>MODEL 815S</b>							
TILT	1U1988		P-UB-10	2	4	CTC-7X2755	147.15

CATERPILLAR®



## REPLACEMENT KITS FOR CATERPILLAR® EQUIPMENT

<b>Soil Compactors</b>							
APPLICATION	CYL #	Misc-Parts, Instructions, etc.	CODE	ROD	BORE	KIT #	List \$
<b>MODEL 825</b>							
LIFT							
	8J2650		P-UB-10	2	4-1/2	CTC-7X2768	88.67
	9J7934		P-UB-10	2	4-1/2	CTC-7X2768	88.67
STEERING LH							
	9J7087		P-UB-10	2-1/4	5	CTC-7X2729	162.34
STEERING RH							
	9J7086		P-UB-10	2-1/4	5	CTC-7X2729	162.34
TILT							
	9J7951		P-UB-10	2	4-1/2	CTC-7X2768	88.67
<b>MODEL 825B</b>							
LIFT							
	4J9233		P-V-10	2	4-1/2	CTC-7X2770	97.94
	7J9818		P-UB-10	3	7-1/4	CTC-7X2699	215.29
	8J2650		P-UB-10	2	4-1/2	CTC-7X2768	88.67
	9J7934		P-UB-10	2	4-1/2	CTC-7X2768	88.67
STEERING							
	6J7590		P-UB-10	2-1/4	5	CTC-7X2729	162.34
	7J9718		P-UB-10	2-1/4	5	CTC-7X2729	162.34
	7K9401		P-UB-10	2-1/4	5	CTC-7X2729	162.34
STEERING LH							
	9J7087		P-UB-10	2-1/4	5	CTC-7X2729	162.34
STEERING RH							
	9J7086		P-UB-10	2-1/4	5	CTC-7X2729	162.34
TILT							
	9J7951		P-UB-10	2	4-1/2	CTC-7X2768	88.67
<b>MODEL 825C</b>							
LIFT							
	7J9818		P-UB-10	3	7-1/4	CTC-7X2699	215.29
	8J2650		P-UB-10	2	4-1/2	CTC-7X2768	88.67
	9J7934		P-UB-10	2	4-1/2	CTC-7X2768	88.67
STEERING LH							
	9J7087		P-UB-10	2-1/4	5	CTC-9X6392	160.01
STEERING RH							
	9J7086		P-UB-10	2-1/4	5	CTC-9X6392	160.01
TILT							
	9J7951		P-UB-10	2	4-1/2	CTC-7X2768	88.67
<b>MODEL 825G</b>							
LIFT							
	1199226		P-UB-10	2-1/4	3-3/4	CTC-1361897	159.18
	1447349		P-UB-10	2-1/4	3-3/4	CTC-1361897	159.18
	1493236		P-UB-10	2-1/4	3-3/4	CTC-1361897	159.18
STEERING							
	1175151		P-UB-10	2-1/2	4-1/2	CTC-1113300	136.57
TILT							
	1198863		P-UB-10	2	3-3/4	CTC-7X7938	104.60
<b>MODEL 835</b>							
LIFT							
	4J9233		P-V-10	2	4-1/2	CTC-7X2770	97.94
STEERING							
	7J9984		P-UB-10	2-1/4	5	CTC-7X2729	162.34
<b>Telehandlers</b>							
APPLICATION	CYL #	Misc-Parts, Instructions, etc.	CODE	ROD	BORE	KIT #	List \$
<b>MODEL TH62, TH63, TH82, TH83</b>							
MULTIPURPOSE BUCKET							
	9T4006		P-UB-10	1-1/2	3	CTC-1856583	45.80
UNSPECIFIED APPLICATION							
	9T4006		P-UB-10	1-1/2	3	CTC-7X2737	108.60

**CATERPILLAR®**



## REPLACEMENT KITS FOR CATERPILLAR® EQUIPMENT

<b>Wheel Dozers</b>							
APPLICATION	CYL #	Misc-Parts, Instructions, etc.	CODE	ROD	BORE	KIT #	List \$
<b>MODEL 814</b>							
BLADE TIP							
	1U4744		P-UB-10	2	4	CTC-7X2755	147.15
DOZER							
	7J7028		P-UB-10	2-1/2	4-3/4	CTC-7X2773	178.40
DOZER LIFT							
	7J7028		P-UB-10	2-1/2	4-3/4	CTC-7X2660	179.61
LIFT							
	1U2088		P-UB-10	2-1/2	4-3/4	CTC-7X2660	179.61
LIFT RH							
	4J7859		P-UB-10	2	4	CTC-7X2755	147.15
STEERING							
	4T1574		P-UB-10	2	4	CTC-1328816	92.75
STEERING LH							
	7J9356		P-UB-10	2	4	CTC-7X2755	147.15
STEERING RH							
	7J9355		P-UB-10	2	4	CTC-7X2755	147.15
TILT							
	7J7295		P-UB-10	2	4-1/2	CTC-7X2768	88.67
<b>MODEL 814B</b>							
BLADE TIP							
	1U4744		P-UB-10	2	4	CTC-7X2755	147.15
DOZER							
	1U2088		P-UB-10	2-1/2	4-3/4	CTC-1328811	161.44
DOZER LIFT							
	1U2088		P-UB-10	2-1/2	4-3/4	CTC-7X2660	179.61
	7J7028		P-UB-10	2-1/2	4-3/4	CTC-7X2660	179.61
STEERING							
	4T1574		P-UB-10	2	4	CTC-1328816	92.75
	6E5024		P-UB-10	2	4	CTC-1113302	118.96
TILT							
	7J7295		P-UB-10	2	4-1/2	CTC-7X2768	88.67
<b>MODEL 814F</b>							
DOZER							
	1U2088		P-UB-10	2-1/2	4-3/4	CTC-1328811	161.44
STEERING							
	4T1574		P-UB-10	2	4	CTC-1328816	92.75
	6E5024		P-UB-10	2	4	CTC-1113302	118.96
<b>MODEL 814S</b>							
BLADE TIP							
	1U4744		P-UB-10	2	4	CTC-7X2755	147.15
TILT							
	7J7295		P-UB-10	2	4-1/2	CTC-7X2768	88.67
<b>MODEL 824</b>							
BLADE TIP							
	4J5632		P-V-10	2-1/2	6-1/2	CTC-7X2678	109.43
	4J6006	App requires 2 kits.	P-UB-10	2-1/2	6	CTC-7X2656	161.24
	4J6006	App requires 2 kits.	P-UB-10	2-1/2	6	CTC-7X2692	164.27
BLADE TIP LH							
	4J4498		P-UB-10	2-1/2	6	CTC-7X2656	161.24

CATERPILLAR®



## REPLACEMENT KITS FOR CATERPILLAR® EQUIPMENT

<b>Wheel Dozers</b>							
APPLICATION	CYL #	Misc-Parts, Instructions, etc.	CODE	ROD	BORE	KIT #	List \$
<b>MODEL 824</b>							
LIFT							
	3J9307		P-V-10	2-1/2	6-1/2	CTC-7X2676	109.43
	4J6005		P-V-10	2-1/2	6-1/2	CTC-7X2676	109.43
	4J7621		P-V-10	2-1/2	6-1/2	CTC-7X2676	109.43
	4J9233		P-V-10	2	4-1/2	CTC-7X2770	97.94
	6J1269		P-V-10	2-1/2	6-1/2	CTC-7X2676	109.43
	6J1272		P-V-10	2-1/2	6-1/2	CTC-7X2676	109.43
	6J1273		P-V-10	2-1/2	6-1/2	CTC-7X2676	109.43
	9J7111		P-UB-10	2-1/2	5-1/2	CTC-7X2653	162.45
STEERING							
	7J9984		P-UB-10	2-1/4	5	CTC-7X2729	162.34
STEERING LH							
	9J7087		P-UB-10	2-1/4	5	CTC-7X2729	162.34
STEERING RH							
	9J7086		P-UB-10	2-1/4	5	CTC-7X2729	162.34
TILT RH							
	4J4497		P-V-10	2-1/2	6-1/2	CTC-7X2678	109.43
<b>MODEL 824B</b>							
BLADE							
	7K9401		P-UB-10	2-1/4	5	CTC-7X2729	162.34
BLADE LH							
	4J4498		P-UB-10	2-1/2	6	CTC-7X2656	161.24
BLADE TIP							
	4J6006	App requires 2 kits.	P-UB-10	2-1/2	6	CTC-7X2656	161.24
BLADE TIP LH							
	4J4498		P-UB-10	2-1/2	6	CTC-7X2656	161.24
LIFT							
	3J9307		P-V-10	2-1/2	6-1/2	CTC-7X2676	109.43
	4J6005		P-V-10	2-1/2	6-1/2	CTC-7X2676	109.43
	4J7621		P-V-10	2-1/2	6-1/2	CTC-7X2676	109.43
	4J9233		P-V-10	2	4-1/2	CTC-7X2770	97.94
	6J1269		P-V-10	2-1/2	6-1/2	CTC-7X2676	109.43
	6J1272		P-V-10	2-1/2	6-1/2	CTC-7X2676	109.43
	6J1273		P-V-10	2-1/2	6-1/2	CTC-7X2676	109.43
	9J7111		P-UB-10	2-1/2	5-1/2	CTC-7X2653	162.45
STEERING							
	6J7590		P-UB-10	2-1/4	5	CTC-7X2729	162.34
	7J9718		P-UB-10	2-1/4	5	CTC-7X2729	162.34
	7J9984		P-UB-10	2-1/4	5	CTC-7X2729	162.34
STEERING LH							
	9J7087		P-UB-10	2-1/4	5	CTC-7X2729	162.34
STEERING RH							
	9J7086		P-UB-10	2-1/4	5	CTC-7X2729	162.34
TILT RH							
	4J4497		P-V-10	2-1/2	6-1/2	CTC-7X2678	109.43
<b>MODEL 824C</b>							
BLADE LH							
	4J4498		P-UB-10	2-1/2	6	CTC-7X2656	161.24
BLADE RH							
	4J4497		P-V-10	2-1/2	6-1/2	CTC-7X2678	109.43
BLADE TIP							
	4J4497		P-V-10	2-1/2	6-1/2	CTC-7X2678	109.43
	4J5632		P-V-10	2-1/2	6-1/2	CTC-7X2678	109.43
	4J6006	App requires 2 kits.	P-UB-10	2-1/2	6	CTC-7X2656	161.24
BLADE TIP LH							
	4J4498		P-UB-10	2-1/2	6	CTC-7X2656	161.24

**CATERPILLAR®**



## REPLACEMENT KITS FOR CATERPILLAR® EQUIPMENT

Wheel Dozers							
APPLICATION	CYL #	Misc-Parts, Instructions, etc.	CODE	ROD	BORE	KIT #	List \$
<b>MODEL 824C</b>							
LIFT							
	4J6005		P-V-10	2-1/2	6-1/2	CTC-7X2676	109.43
	6J1269		P-V-10	2-1/2	6-1/2	CTC-7X2676	109.43
	6J1272		P-V-10	2-1/2	6-1/2	CTC-7X2676	109.43
	6J1273		P-V-10	2-1/2	6-1/2	CTC-7X2676	109.43
	9J7111		P-UB-10	2-1/2	5-1/2	CTC-7X2653	162.45
LIFT LH							
	4J4498		P-UB-10	2-1/2	6	CTC-7X2656	161.24
STEERING LH							
	9J7087		P-UB-10	2-1/4	5	CTC-9X6392	160.01
STEERING RH							
	9J7086		P-UB-10	2-1/4	5	CTC-9X6392	160.01
<b>MODEL 824S, 834S, 834U</b>							
LIFT LH							
	4J4498		P-UB-10	2-1/2	6	CTC-7X2656	161.24
TILT RH							
	4J4497		P-V-10	2-1/2	6-1/2	CTC-7X2678	109.43
<b>MODEL 830M</b>							
DOZER LIFT							
	3R4109		P-UB-10	2-1/2	4-3/4	CTC-7X2660	179.61
LIFT							
	3J6439		P-UB-10	2-1/2	6	CTC-7X2679	138.16
RIPPER LIFT							
	3R6724		P-UB-10	2-1/2	6	CTC-7X2679	138.16
STEERING							
	5R0062		P-UB-10	2-1/4	5	CTC-7X2729	162.34
	7J9984		P-UB-10	2-1/4	5	CTC-7X2729	162.34
<b>MODEL 834</b>							
BLADE LH							
	4J4498		P-UB-10	2-1/2	6	CTC-7X2656	161.24
BLADE TIP							
	4J5632		P-V-10	2-1/2	6-1/2	CTC-7X2678	109.43
	4J6006	App requires 2 kits.	P-UB-10	2-1/2	6	CTC-7X2656	161.24
LIFT							
	4J6005		P-V-10	2-1/2	6-1/2	CTC-7X2676	109.43
	4J7621		P-V-10	2-1/2	6-1/2	CTC-7X2676	109.43
	4J9233		P-V-10	2	4-1/2	CTC-7X2770	97.94
	6J1269		P-V-10	2-1/2	6-1/2	CTC-7X2676	109.43
	6J1272		P-V-10	2-1/2	6-1/2	CTC-7X2676	109.43
STEERING							
	7J9984		P-UB-10	2-1/4	5	CTC-7X2729	162.34
	9J8165		P-UB-10	2-1/4	5	CTC-9X6392	160.01
TILT RH							
	4J4497		P-V-10	2-1/2	6-1/2	CTC-7X2678	109.43
<b>MODEL 834B</b>							
BLADE LH							
	4J4498		P-UB-10	2-1/2	6	CTC-7X2656	161.24
BLADE TIP							
	4J5632		P-V-10	2-1/2	6-1/2	CTC-7X2678	109.43
LIFT							
	4J7621		P-V-10	2-1/2	6-1/2	CTC-7X2676	109.43
	6J1272		P-V-10	2-1/2	6-1/2	CTC-7X2676	109.43
LIFT LH							
	4J4498		P-UB-10	2-1/2	6	CTC-7X2656	161.24
STEERING							
	9J8165		P-UB-10	2-1/4	5	CTC-9X6392	160.01



## REPLACEMENT KITS FOR CATERPILLAR® EQUIPMENT

<b>Wheel Dozers</b>							
APPLICATION	CYL #	Misc-Parts, Instructions, etc.	CODE	ROD	BORE	KIT #	List \$
<b>MODEL 834B</b>							
TILT RH							
	4J4497		P-V-10	2-1/2	6-1/2	CTC-7X2678	109.43
TIP							
	4J6006	App requires 2 kits.	P-UB-10	2-1/2	6	CTC-7X2656	161.24
<b>MODEL 834C</b>							
BLADE TIP							
	4J5632		P-V-10	2-1/2	6-1/2	CTC-7X2678	109.43
	4J6006	App requires 2 kits.	P-UB-10	2-1/2	6	CTC-7X2656	161.24

**CATERPILLAR®**





# REPLACEMENT KITS FOR CATERPILLAR® EQUIPMENT

## IMPORTANT – PLEASE READ

If a kit part number is unknown, the machine model number, serial number, and cylinder application will help identify the repair kit you need.

**Example:** Model Number **D5**  
 Serial Number **63J806**  
 Cylinder Application **Dozer Lift**

If none of the above information is known, size and description of the parts needed will almost always be sufficient.

**NOTE:** CATERPILLAR® kit numbers are used as a reference only. We do not imply that these kits are original REPLACEMENT KITS.

CATERPILLAR®

Kit Number	Code (Pg. xviii)	Rod X Bore Size	List Price	Kit Number	Code (Pg. xviii)	Rod X Bore Size	List Price
CTC-FIG0401	TRACK ADJUSTER KIT		\$103.67	CTC-0964395	P-UB-10	85 mm X 120 mm	\$388.95
CTC-FIG0402	TRACK ADJUSTER KIT		122.15	CTC-0964396	P-UB-10	95 mm X 130 mm	429.12
CTC-FIG0405	TRACK ADJUSTER KIT		108.68	CTC-0966457	P-UB-10	75 mm X 115 mm	360.69
CTC-FIG1401	TRACK ADJUSTER KIT		114.41	CTC-0967625	P-UB-10	65 x 100 mm	337.15
CTC-FIG1402	TRACK ADJUSTER KIT		127.56	CTC-0967786	P-UB-10	75 x 110 mm	353.15
CTC-FIG1405	TRACK ADJUSTER KIT		66.79	CTC-0967799	P-UB-10	80 mm X 120 mm	340.35
CTC-FIG3400	TRACK ADJUSTER KIT		59.82	CTC-0974392	P-UB-10	3 X 7-1/4	87.43
CTC-FIG3401	TRACK ADJUSTER KIT		55.84	CTC-0976094	P-UB-10	3 X 6-1/4	126.27
CTC-FIG3404	TRACK ADJUSTER KIT		46.26	CTC-0995310	P-UB-14	75 mm X 110 mm	271.87
CTC-FIG4400	TRACK ADJUSTER KIT		48.04	CTC-0995311	P-UB-14	80 mm X 120 mm	290.14
CTC-FIG4405	TRACK ADJUSTER KIT		22.37	CTC-0995312	P-UB-14	65 mm X 100 mm	294.68
CTC-0514131	P-V-10	2-1/2 X 6	122.55	CTC-0995401	P-UB-14	70 X 100 mm	232.17
CTC-0543309	I-UB-10	2-1/4 X 3-1/2	49.84	CTC-0996978	P-UB-14	60 X 90 mm	125.61
CTC-0555211	I-U-10	3-1/2,5-1/2,6-1/2 X 5,6,7	309.85	CTC-0997004	P-UB-14	55 X 80 mm	124.45
CTC-0711436	I-U-3	11 X 13-1/8	1200.82	CTC-1002931	P-UB-10	3-1/4 X 5-1/2	396.42
CTC-0712436	P-U-3	11 X 13-1/8	1283.68	CTC-1002932	P-UB-10	3-1/4 X 5-1/2	396.91
CTC-0715438	I-SP-10,3	7-1/4,10-1/2 X 9-1/4, 11-1/2	736.15	CTC-1002934	P-UB-10	4-1/4 X 6-1/2	401.89
CTC-0716439	I-SP-10,3	7-1/4,11	752.82	CTC-1002935	P-UB-10	4-1/4 X 6-1/2	409.09
CTC-0717440	I-U-3	12-1/2 X 15-1/8	1735.90	CTC-1002939	P-UB-10	3-3/4 X 6	551.13
CTC-0718440	P-U-3	12-1/2 X 15-1/8	1735.66	CTC-1007844K	P-UB-10	2 X 4	43.01
CTC-0719441	I-U-3	12-1/2 X 14-1/4	731.23	CTC-1007844K	P-UB-10	2 X 4	43.01
CTC-0720441	P-U-3	12-1/2 X 14-1/4	600.86	CTC-1014201	P-UB-10	2-1/2 X 4-3/4	133.98
CTC-0728446	P-UB-1	9 X 10-3/4	1398.03	CTC-1014867	P-V-10	3 X 6-1/4	154.18
CTC-0778441	P-U-3	12-1/2 X 14-1/4	1644.85	CTC-1014874	P-UB-10	2-3/4 X 6-1/2	117.76
CTC-0860174	P-UB-14	75 x 100 mm	270.29	CTC-1016061	I-U-10	30 X 63 mm	125.98
CTC-0875387	P-UB-10	100 X 140 mm	341.66	CTC-1017554	P-UB-10	5-1/2 X 10-1/2	356.75
CTC-0875394	P-UB-10	85 X 120 mm	258.77	CTC-1038333	P-UB-14	60 X 90 mm	247.83
CTC-0875407	P-UB-10	130 X 180 mm	398.13	CTC-1040763	P-U-1	70 mm Rod Kit	50.04
CTC-0876654	P-UB-10	110 X 160 mm	320.96	CTC-1041023	P-U-1	75 mm Rod Kit	47.28
CTC-0901523	MULTI STAGE 2.50, 3.25, 4.00		126.88	CTC-1045008	I-U-10	4 X 4-1/2	278.38
CTC-0904400	N-U-1	1-1/2	43.73	CTC-1052585	P-UB-10	90 X 130 mm	484.06
CTC-0911700	I-U-1	75 mm	43.57	CTC-1052601	P-UB-10	85 X 130 mm	433.38
CTC-0912786	I-V-1	5,9	481.15	CTC-1057253	P-UB-14	55 X 80 mm	184.71
CTC-0919842	P-U-14	45 X 90 mm	79.86	CTC-1057255	P-UB-14	75 X 110 mm	272.11
CTC-0933045	P-UB-15	50 mm X 90mm	327.93	CTC-1057359	P-UB-10	80 X 100 mm	245.15
CTC-0938385	P-UB-15	70 mm X 110 mm	228.74	CTC-1057379	P-UB-10	85 X 120 mm	259.18
CTC-0938388	P-UB-15	80 mm X 120 mm	381.60	CTC-1057397	P-UB-10	70 X 100 mm	202.76
CTC-0938390	P-UB-15	65 mm X 110 mm	338.42	CTC-1057480	P-UB-14	55 X 100 mm	211.26
CTC-0939941	P-UB-14	90 mm X 140 mm	306.12	CTC-1113203	O-Ring Kit		10.48
CTC-0940691	P-UB-10	85 mm X 125 mm	322.75	CTC-1113300	P-UB-10	2-1/2 X 4-1/2	136.57
CTC-0941910	P-UB-10	100 mm X 140 mm	385.24	CTC-1113301	P-UB-10	1-7/8 X 3	131.00
CTC-0942697	P-UB-14	100 mm X 150 mm	256.02	CTC-1113302	P-UB-10	2 X 4	118.96
CTC-0942698	P-UB-14	110 mm X 160 mm	389.76	CTC-1118211K	P-UB-10	2-5/8 X 5-1/4	106.86

# REPLACEMENT KITS FOR CATERPILLAR® EQUIPMENT

**NOTE:** CATERPILLAR® kit numbers are used as a reference only. We do not imply that these kits are original REPLACEMENT KITS.

Kit Number	Code (Pg. xviii)	Rod X Bore Size	List Price	Kit Number	Code (Pg. xviii)	Rod X Bore Size	List Price
CTC-1118211K	P-UB-10	2-5/8 X 5-1/4	\$106.86	CTC-1270630	P-UB-10	100 X 140 mm	\$340.15
CTC-1125343	I-SP-10, 3	8-3/4, 12-1/2 X 11, 13-3/4	862.58	CTC-1270631	P-UB-10	100 X 140 mm	342.45
CTC-1126550	P-UB-10	3 X 6-1/2	177.23	CTC-1270795	P-UB-10	2-1/2 X 5	118.51
CTC-1126552	P-UB-10	3 X 6-1/2	231.80	CTC-1279809	P-UB-10	3 X 6-1/2	231.47
CTC-1131073	I,P-U-3	12 X 15-1/8	1951.90	CTC-1281187	P-UB-10	3-1/4 X 7	266.07
CTC-1132693	I-U-3	1-1/4 X 2-1/2	16.71	CTC-1281673	P-UB-10	3 x 5-1/2	228.55
CTC-1137463	I, P-U-3	9 X 10-3/4	1884.15	CTC-1289277	P-UB-10	105 X 150 mm	367.94
CTC-1137472	I,P-U-3	13-1/2 X 16-1/8	1928.72	CTC-1289278	P-UB-10	110 X 170 mm	397.28
CTC-1137475	P-UB-3	7 X 8	457.29	CTC-1289280	P-UB-10	110 X 160 mm	385.33
CTC-1137476	I,P-U-3	11 X 13-1/8	1604.66	CTC-1296156	P-UB-10	100 X 170 mm	192.88
CTC-1137478	P-UB-3	7 X 8	655.52	CTC-1304012	P-UB-10	2-1/2 X 5	191.35
CTC-1137480	I,P-U-3	12-1/2 X 14-1/4	907.36	CTC-1305923	P-UB-10	2-1/8 X 4	158.53
CTC-1137482	I-UB-3	9 X 10-1/2	357.02	CTC-1309466	P-UB-10	3 X 6	235.32
CTC-1143616	O-RING KIT		6.14	CTC-1309483	P-UB-10	3-1/2 x 7-1/4	330.34
CTC-1148131K	P-UB-10	3 X 4-3/4	194.23	CTC-1309763	P-UB-10	4-1/4 X 7-3/4	381.58
CTC-1148290	P-UB-10	80 X 120 mm	202.92	CTC-1309771	P-UB-1	4-1/4	267.16
CTC-1148526	P-UB-10	75 X 110 mm	239.80	CTC-1315083	P-UB-10	3-1/2 X 6-1/4	134.59
CTC-1153523K	P-UB-10	3 X 6-1/2	118.85	CTC-1315088	P-UB-10	2-1/4 X 4-1/4	157.63
CTC-1153524K	P-UB-10	2-1/4 X 3-3/4	56.57	CTC-1315106	P-UB-10	2-1/2 X 5	168.91
CTC-1156963K	P-UB-10	2-3/4 X 4-1/2	120.33	CTC-1315118	P-UB-10	2-1/2 X 5	177.89
CTC-1163529	P-UB-10	150 X 220 mm	583.39	CTC-1315164	P-UB-10	2-1/2 X 6	203.42
CTC-1163612	P-UB-10	105 X 150 mm	301.76	CTC-1315420	I-U-10	2-3/4 X 4	158.09
CTC-1163649	P-UB-10	110 X 170 mm	376.59	CTC-1315421	I-UB-10	2 X 4	145.05
CTC-1169123K	P-UB-10	105 X 150 mm	188.27	CTC-1315423	P-UB-10	3 X 4	212.85
CTC-1180672	I-U-10	6 X 8-1/4	654.76	CTC-1315424	P-UB-10	3-1/2 X 4-1/2	213.62
CTC-1183135	I-U-10	60 X 100 mm	93.83	CTC-1316108	P-UB-10	1-3/4 X 4	108.64
CTC-1183135	I-U-10	60 mm X 100 mm	93.83	CTC-1316109	P-UB-10	3 X 4-3/4	112.57
CTC-1183946	P-UB-10	110 X 160 mm	364.69	CTC-1316117	P-UB-10	3-1/2 X 6-1/4	245.53
CTC-1184024	P-UB-10	100 X 140 mm	325.48	CTC-1316122	P-UB-5	3-1/2 X 4-1/2	240.75
CTC-1184131	P-UB-10	85 X 120 mm	249.86	CTC-1318700	P-UB-10	2-1/2 X 3-3/4	150.91
CTC-1184175	P-UB-10	90 X 130 mm	295.27	CTC-1318733	P-UB-10	3 X 6-1/2	206.11
CTC-1186023	P-UB-10	85 X 120 mm	266.33	CTC-1318740	P-UB-10	3 X 6-1/2	173.30
CTC-1195435	P-UB-10	75 X 110 mm	295.44	CTC-1318748	P-UB-10	2-1/2 X 4	153.96
CTC-1195446	P-UB-10	80 X 120 mm	269.53	CTC-1318778	P-UB-10	2-1/4 x 4-3/4	140.11
CTC-1195457	P-UB-10	65 X 100 mm	214.51	CTC-1321417	P-UB-10	2-1/4 X 3-3/4	137.71
CTC-1211405	P-UB-10	70 X 100 mm	273.28	CTC-1324905	P-UB-10	3-1/2 X 8-1/4	209.96
CTC-1211577	O-RING KIT		127.42	CTC-1324922	P-UB-10	4 X 9-1/4	319.24
CTC-1231768	P-UB-10	75 X 120 mm	289.23	CTC-1324932	P-UB-10	4 x 10-1/2	361.38
CTC-1231771	P-UB-10	70 X 100 mm	258.76	CTC-1324937	P-UB-10	3 X 6	133.88
CTC-1234121K	P-UB-10	2 X 4	76.56	CTC-1324987	P-UB-10	3-1/4 X 7-1/4	243.58
CTC-1239920	P-UB-10	70 X 130 mm	242.03	CTC-1324993	P-UB-10	3-1/4 X 7-3/4	255.26
CTC-1247005	P-UB-10	85 X 160 mm	201.82	CTC-1325123K	P-UB-10	3-1/4 X 7-1/4	166.64
CTC-1247007	P-UB-10	80 X 110 mm	260.70	CTC-1325123K	P-UB-10	3-1/4 X 7-1/4	166.64
CTC-1247008	P-UB-10	85 X 120 mm	157.23	CTC-1325149K	P-UB-10	3 X 6	144.69
CTC-1247009	P-UB-10	80 X 110 mm	222.15	CTC-1325149K	P-UB-10	3 X 6	144.69
CTC-1257895K	P-UB-10	2-1/4 X 3-3/4	52.78	CTC-1326121	P-UB-10	2-3/4 x 5-1/4	209.57
CTC-1257895K	P-UB-10	2-1/4 X 3-3/4	52.78	CTC-1326127	P-UB-10	3 X 7-1/4	207.98
CTC-1261887	P-UB-10	90 X 130 mm	427.68	CTC-1326130	P-UB-10	3-1/2 X 7-1/4	241.17
CTC-1261937	P-UB-10	85 X 120 mm	135.61	CTC-1326148	P-UB-10	2-3/4 X 4-1/4	171.53
CTC-1261947	P-UB-10	85 X 120 mm	346.12	CTC-1326170	P-UB-10	2-3/4 X 4-1/4	171.24
CTC-1261979	P-UB-10	130 X 190 mm	294.32	CTC-1326180	P-UB-10	3 X 7-1/4	212.71

# REPLACEMENT KITS FOR CATERPILLAR® EQUIPMENT

**NOTE:** CATERPILLAR® kit numbers are used as a reference only. We do not imply that these kits are original REPLACEMENT KITS.

**CATERPILLAR®**

Kit Number	Code (Pg. xviii)	Rod X Bore Size	List Price	Kit Number	Code (Pg. xviii)	Rod X Bore Size	List Price
CTC-1326184	P-UB-10	3 X 7-1/4	\$225.89	CTC-1361599	P-UB-10	1-1/2 X 2-3/4	\$106.50
CTC-1326770	P-UB-10	2-1/4 X 4-1/2	150.17	CTC-1361897	P-UB-10	2-1/4 X 3-3/4	159.18
CTC-1326783	P-UB-10	4 X 7	259.77	CTC-1361908	P-UB-10	2-5/8 X 5-1/4	176.83
CTC-1326806	P-UB-10	4 X 7	354.43	CTC-1361967	P-UB-10	2-1/2 X 5	193.76
CTC-1327058	P-UB-10	1-1/2 X 3-1/2	103.88	CTC-1361990	P-UB-10	2-3/4 X 3-3/4	173.89
CTC-1327114	P-UB-10	2-1/2 X 4-1/4	156.55	CTC-1362025	P-UB-10	3 X 4-3/4	209.10
CTC-1327123	P-UB-10	2-1/2 X 5-1/2	179.24	CTC-1362721	P-UB-10	3-1/2 X 7-1/2	191.41
CTC-1327129	P-UB-10	2-3/4 X 5-1/2	180.32	CTC-1363084	P-UB-10	3 x 6	141.11
CTC-1327131	P-UB-10	2-3/4 X 5-1/2	200.35	CTC-1363121	P-UB-10	2-1/2 X 6	164.51
CTC-1328088	P-UB-10	2-3/4 X 6-1/2	206.61	CTC-1363337	P-UB-10	2-3/4 X 6	77.95
CTC-1328111	P-UB-10	2-3/4 X 5-1/2	181.49	CTC-1363741	P-UB-10	3 X 6-1/2	157.46
CTC-1328284	P-UB-10	2-3/4 X 7	133.09	CTC-1365158	P-UB-10	3-1/2 X 6-1/4	206.84
CTC-1328491	P-UB-10	3 X 6-1/4	260.49	CTC-1368341	P-UB-10	2-1/2 X 6-1/2	162.98
CTC-1328518	P-UB-10	3-1/4 X 7	229.26	CTC-1368797	P-UB-10	3-1/4 X 6-1/2	221.49
CTC-1328576	P-UB-10	3-1/4 X 9-1/4	321.17	CTC-1368865	P-UB-10	4 X 6-1/2	353.65
CTC-1328608	P-UB-10	3-1/4 X 9-1/4	241.74	CTC-1370264	P-UB-10	2-1/2 X 6-1/2	175.56
CTC-1328620	P-UB-10	3-1/4 X 7-1/4	221.33	CTC-1370315	P-UB-10	2-3/4 X 7-1/4	233.29
CTC-1328633	P-UB-10	1-1/2 X 3-1/4	109.64	CTC-1371384	P-UB-10	3-1/4 X 9-1/4	230.43
CTC-1328770	P-UB-10	1-3/4 X 3-1/4	120.66	CTC-1371762	P-UB-10	4 X 9-1/4	278.99
CTC-1328783	P-V-10	2 X 4-1/2	74.66	CTC-1371774	P-UB-10	4-3/4 X 7-1/4	359.88
CTC-1328811	P-UB-10	2-1/2 X 4-3/4	161.44	CTC-1371946	P-UB-10	4-3/4 X 7	366.08
CTC-1328816	P-UB-10	2 X 4	92.75	CTC-1371955	P-UB-10	4-3/4 X 6-1/2	312.53
CTC-1328849	P-UB-10	1-3/4 X 3	113.25	CTC-1371974	P-UB-10	3-1/2 X 8-1/4	255.18
CTC-1329361	P-UB-10	1-3/4 X 3-3/4	43.30	CTC-1372489	P-UB-10	2-3/4 X 7-1/4	184.33
CTC-1331747K	P-UB-10	2 X 3-1/2	79.41	CTC-1372530	P-UB-10	1-1/2 X 3	90.31
CTC-1332962K	P-UB-10	3-1/4 X 9-1/4	286.29	CTC-1373529	P-UB-10	2-1/4 X 4-1/2	62.58
CTC-1333614	P-UB-10	4 X 7	303.89	CTC-1373602	P-UB-10	2-1/4 X 4-1/2	154.88
CTC-1334759	P-UB-10	3-1/4 X 7	165.33	CTC-1373661	P-UB-10	100 X 140 mm	149.14
CTC-1334802	P-UB-10	3-1/4 X 7	247.73	CTC-1373763	P-UB-10	85 X 120 mm	369.78
CTC-1336646	P-UB-10	80 X 110 mm	247.79	CTC-1373764	P-UB-10	100 X 140 mm	322.72
CTC-1336691	P-UB-10	70 X 100 mm	215.11	CTC-1373765	P-UB-10	90 X 130 mm	475.98
CTC-1336823	P-UB-10	100 X 140 mm	321.13	CTC-1373766	P-UB-10	100 X 140 mm	309.80
CTC-1344485K	P-UB-10	55 X 100 mm	117.98	CTC-1373767	P-UB-10	105 X 150 mm	418.82
CTC-1347127	P-UB-10	90 X 130 mm	408.11	CTC-1373768	P-UB-10	90 X 130 mm	440.48
CTC-1349838K	P-UB-10	35 X 70 mm	156.52	CTC-1378646	P-UB-10	3 X 5-1/4	184.67
CTC-1350532K	P-UB-10	50 X 85 mm	215.01	CTC-1378662	P-UB-10	2 X 4-1/4	135.35
CTC-1352167	P-UB-10	2-3/4 x 6	210.58	CTC-1379011	P-UB-10	55 X 100 mm	251.23
CTC-1353223	P-UB-10	2-1/2 X 4	160.41	CTC-1379403	P-UB-10	105 X 150 mm	363.00
CTC-1353253	P-UB-10	2-1/2 X 4	157.63	CTC-1417296	P-U-3	7 X 8-1/2	273.31
CTC-1353802	P-UB-10	3 x 4-1/2	174.37	CTC-1417483K	P-UB-10	2-1/2 X 4	53.94
CTC-1353829	P-UB-10	3 X 4-1/2	203.33	CTC-1417484K	P-UB-10	2-1/2 X 5-1/4	82.09
CTC-1354382	P-UB-10	5-3/4 X 11-1/2	451.31	CTC-1417975	P-UB-4	3-1/2 X 4-1/2	159.90
CTC-1354392	P-UB-10	2-1/4 x 4-1/2	140.37	CTC-1425428	P-UB-10	65 X 100 mm	283.90
CTC-1354402	P-UB-10	3-1/4 X 8-1/4	249.40	CTC-1428962	I-U-10	35 X 50 mm	49.88
CTC-1354446	P-V-10	3-1/4 X 7-1/4	206.97	CTC-1428962	I-U-10	35 mm X 50 mm	49.88
CTC-1354539	P-UB-14	3-1/4 X 5-1/2	123.08	CTC-1428963	P-UB-10	30 X 65 mm	98.98
CTC-1358166	P-UB-10	2-1/4 X 3-1/2	171.50	CTC-1428963	P-U-10	30 mm X 65 mm	98.98
CTC-1358695	P-UB-10	2-1/2 X 4-3/4	95.21	CTC-1429192	P-U-10	35 mm X 70 mm	48.06
CTC-1358736	P-UB-10	2-3/4 X 5-1/2	212.05	CTC-1429193	P-U-10	40 mm X 60 mm	73.58
CTC-1361131	P-UB-10	2-1/2 x 4-3/4	143.18	CTC-1432918	P-UB-10	3 X 5-1/4	185.82
CTC-1361171	P-UB-10	2-1/4 X 4	101.36	CTC-1433201K	P-UB-10	100 X 170 mm	240.39

# REPLACEMENT KITS FOR CATERPILLAR® EQUIPMENT

**NOTE:** CATERPILLAR® kit numbers are used as a reference only. We do not imply that these kits are original REPLACEMENT KITS.

Kit Number	Code (Pg. xviii)	Rod X Bore Size	List Price	Kit Number	Code (Pg. xviii)	Rod X Bore Size	List Price
CTC-1437982	P-UB-14	75 X 110 mm	\$335.44	CTC-1588925	P-UB-10	70 X 100 mm	\$226.43
CTC-1437983	P-UB-14	60 X 90 mm	276.21	CTC-1588926	P-UB-10	80 X 110 mm	250.57
CTC-1438152	P-UB-10	70 X 100 mm	254.06	CTC-1589092	P-UB-10	85 X 120 mm	182.36
CTC-1438153	P-UB-10	65X100 mm	264.45	CTC-1589093	P-UB-10	100 X 140 mm	122.51
CTC-1449005K	P-UB-10	3-1/4 X 8-1/4	174.90	CTC-1597773	P-UB-10	85 X 120 mm	528.22
CTC-1456902	O-Ring Kit	O-Ring Kit	5.21	CTC-1597774	P-UB-10	100 X 140 mm	151.13
CTC-1469624	P-UB-10	3-1/4 X 9-1/4	240.74	CTC-1597775	P-UB-10	85 X 120 mm	177.68
CTC-1469631	P-UB-10	3-1/4 X 9-1/4	243.91	CTC-1597776	P-UB-10	90 X 130 mm	522.65
CTC-1469860	P-UB-10	2-1/2 X 4-1/2	161.26	CTC-1597778	P-UB-10	85 X 130 mm	484.22
CTC-1475781	P-UB-10	85 x 125 mm	287.61	CTC-1600045K	P-UB-10	2-1/2 X 4-3/4	101.38
CTC-1475839	P-UB-10	85 X 120 mm	282.65	CTC-1600054K	P-UB-10	2-1/2 X 5-1/2	79.98
CTC-1509211K	P-U-10	45 X 75 mm	60.08	CTC-1605784	P-UB-10	3 X 5	72.44
CTC-1511266K	P-U-10	45 X 75 mm	50.98	CTC-1605795	P-UB-10	2-1/2 X 5-1/4	176.42
CTC-1512460K	P-U-10	40 X 70 mm	44.80	CTC-1605796	P-UB-10	3 x 7	303.16
CTC-1513187K	P-U-10	35 X 65 mm	39.41	CTC-1608546	P-U-10	30 X 60 mm	51.42
CTC-1518206K	P-UB-10	3-1/4 X 8-1/2	349.71	CTC-1609874	O-RINGS		45.12
CTC-1526482K	P-UB-10	1-3/4 X 3-1/2	71.98	CTC-1624675	P-UB-10	80 X 110 mm	295.52
CTC-1526485K	P-UB-10	2 X 4	73.72	CTC-1624676	P-UB-10	85 mm X 120 mm	103.98
CTC-1529148K	P-UB-10	2-3/8 X 4-3/4	99.98	CTC-1636105	P-UB-10	2-3/4 X 4-1/2	161.51
CTC-1531282	I-SP-10, 3	7-3/4, 11-1/2 X 10, 12-1/2	684.69	CTC-1636223	P-UB-10	2-1/2 X 5	265.40
CTC-1533724	P-UB-10	2-1/2 X 4	213.96	CTC-1636935K	P-U-10	50 X 90 mm	118.30
CTC-1534973	P-UB-10	3-1/2 X 8-1/2	283.76	CTC-1636936K	P-U-10	45 X 75 mm	152.57
CTC-1539053	P-UB-10	1-3/4 X 2-3/4	150.78	CTC-1637006K	P-U-10	45 X 80 mm	105.93
CTC-1539054	P-UB-10	1-3/4 X 2-1/2	144.29	CTC-1637007K	P-U-10	45 X 80 mm	105.93
CTC-1540728	P-UB-10	85 X 120 mm	487.73	CTC-1637008K	P-U-10	40 X 70 mm	143.93
CTC-1540735	P-UB-10	100 X 140 mm	371.07	CTC-1643213	P-U-10	30 mm X 60 mm	66.37
CTC-1540744	P-UB-10	85 X 120 mm	469.05	CTC-1645174	P-UB-10	100 X 140 mm	218.76
CTC-1540748	P-UB-10	90 x 130 mm	288.09	CTC-1647174K	P-UB-10	1-1/2 X 3	51.66
CTC-1540757	P-UB-10	90 X 130mm	448.38	CTC-1649430K	P-UB-10	1-1/4 X 2-1/2	49.20
CTC-1540761	P-UB-10	100 X 140 mm	382.25	CTC-1650102K	P-UB-10	3 X 6-1/2	163.22
CTC-1540766	P-UB-10	105 X 150 mm	392.44	CTC-1656035	P-UB-10	2-1/2 X 6-1/2	180.46
CTC-1540773	P-UB-10	90 X 130mm	448.08	CTC-1658633K	P-UB-10	3 X 4-3/4	129.58
CTC-1542501	P-UB-10	2-1/2 X 4	151.42	CTC-1659276K	P-UB-14	60 X 90 mm	119.68
CTC-1542502	P-UB-10	2-1/2 X 7-1/4	193.44	CTC-1659416	P-UB-10	130 X 190 mm	294.88
CTC-1542503	P-UB-10	3 X 4-3/4	125.15	CTC-1659418	P-UB-10	85 X 120 mm	139.80
CTC-1546525	P-UB-10	2-1/4 X 4-3/4	153.50	CTC-1659419	P-UB-10	95 mm X 130 mm	226.10
CTC-1546526	P-UB-10	2-1/4 X 4	150.74	CTC-1659420	P-UB-10	80 X110 mm	139.06
CTC-1553652K	P-UB-10	3 X 6-1/2	150.56	CTC-1662835K	P-U-10	45 X 75 mm	50.29
CTC-1553653K	P-UB-10	3 X 7-1/4	180.17	CTC-1668140K	I-UB-10	2-3/4 X 3-3/4	79.86
CTC-1558421	I-U-15	60 mm X 110 mm	73.41	CTC-1668141K	I-UB-10	2-3/4 X 3-3/4	79.86
CTC-1560625	P-UB-10	130 X 180 mm	421.20	CTC-1677551K	P-UB-10	2 X 4-1/4	50.16
CTC-1560626	P-UB-10	140 x 200 mm	652.90	CTC-1680758	P-UB-10	105 X 150 mm	349.00
CTC-1560627	P-UB-10	150 X 220 mm	583.39	CTC-1680759	P-UB-10	110 X 170 mm	400.71
CTC-1563798	P-UB-10	2-1/2 X 4-3/4	155.28	CTC-1680760	P-UB-10	110 X 160 mm	388.71
CTC-1565208	P-UB-10	1-1/2 X 2-1/2	101.05	CTC-1686942K	P-UB-10	5 X 9-1/4	337.22
CTC-1570284	P-UB-10	3-1/2 x 7-3/4	322.47	CTC-1686943K	P-UB-10	5 X 9-1/4	337.22
CTC-1570286	P-UB-10	2-1/2 X 5-1/2	170.84	CTC-1686944K	P-UB-10	4-1/2 X 9-1/4	380.96
CTC-1570287	P-UB-10	2-3/4 X 5-1/2	148.64	CTC-1697826	P-U-15	75 X 110 mm	133.09
CTC-1570288	P-UB-10	3 X 4-3/4	172.37	CTC-1697827	P-UB-14	60 mm X 90 mm	206.73
CTC-1570290	P-UB-10	2 X 4	135.12	CTC-1697828	P-UB-14	55 X 80 mm	150.03
CTC-1586389	P-UB-10	75 X 110 mm	209.70	CTC-1697829	P-UB-14	55 X 100 mm	142.79

# REPLACEMENT KITS FOR CATERPILLAR® EQUIPMENT

**NOTE:** CATERPILLAR® kit numbers are used as a reference only. We do not imply that these kits are original REPLACEMENT KITS.

Kit Number	Code (Pg. xviii)	Rod X Bore Size	List Price	Kit Number	Code (Pg. xviii)	Rod X Bore Size	List Price
CTC-1697830	P-UB-10	65 mm X 100 mm	\$114.99	CTC-1799764K	P-UB-10	90 X 130 mm	\$125.06
CTC-1697831	P-UB-10	75 X 120 mm	359.83	CTC-1799772	P-U-10	90 X 130 mm	206.74
CTC-1697832	P-UB-10	70 X 100 mm	303.12	CTC-1799785K	P-UB-10	105 X 150 mm	175.50
CTC-1697834	P-UB-10	55 X 100 mm	243.05	CTC-1799791K	P-UB-10	105 X 150 mm	339.96
CTC-1697835	P-UB-10	80 X 120 mm	216.22	CTC-1800062	P-UB-10	2-1/8 X 4	157.28
CTC-1697837	P-UB-10	75 x 110 mm	259.73	CTC-1807208	P-U,UB-10	2 X 4	128.47
CTC-1697838	P-UB-10	80 x 120 mm	271.32	CTC-1807482K	P-UB-10	2 X 85 mm	138.57
CTC-1697839	P-UB-10	65 x 100 mm	219.03	CTC-1807484K	P-UB-10	2-1/8 X 4	100.01
CTC-1697842	P-UB-10	65 X 100 mm	300.58	CTC-1807485K	P-UB-10	2-1/8 X 4	100.01
CTC-1697843	P-UB-10	70 X 130 mm	293.89	CTC-1807490K	P-UB-10	2 X 85 mm	138.57
CTC-1697845	P-UB-14	55 X 80 mm	123.64	CTC-1809872	I-U-10	1 X 2	117.91
CTC-1697895	P-UB-14	55 X 90 mm	205.63	CTC-1832091	I-U-10	1 X 2	11.59
CTC-1699529K	P-UB-10	2 X 4	72.66	CTC-1832848K	P-UB-10	2 X 85 mm	92.61
CTC-1699531K	P-UB-10	2 X 4	69.03	CTC-1832849K	P-UB-10	2-3/4 X 5-3/8	143.49
CTC-1700221	P-UB-10	2-1/2 X 4-3/4	141.65	CTC-1832850K	P-UB-10	2-1/2 X 4-3/4	159.19
CTC-1709827	P-UB-10	70 X 100 mm	109.67	CTC-1832856K	P-UB-10	2 X 85 mm	138.57
CTC-1709929	P-UB-10	70 X 100 mm	310.85	CTC-1833721K	P-UB-10	1-1/2 X 3-1/2	69.86
CTC-1709937	P-UB-10	75 X 110 mm	155.78	CTC-1838459K	P-UB-10	1-1/2 X 3-1/2	72.54
CTC-1709941	P-UB-10	65 X 100 mm	129.73	CTC-1843709K	P-UB-10	2-1/2 X 4-1/2	73.54
CTC-1709946	P-UB-10	80 X 120 mm	347.28	CTC-1847660K	P-UB-10	85 X 140 mm	135.48
CTC-1709999	P-UB-10	80 X 120 mm	192.56	CTC-1850196	P-UB-10	90 X 130 mm	165.14
CTC-1721685	P-UB-10	2 X 3	135.92	CTC-1850223	P-UB-10	85 X 125 mm	165.71
CTC-1721688	P-UB-10	2-3/4 X 4	158.83	CTC-1851839K	P-UB-10	1-1/2 X 3	40.75
CTC-1721689	I-UB-5	2 X 4-1/2	182.89	CTC-1851851K	P-UB-10	1-7/8 X 3-1/4	44.30
CTC-1721690	P-UB-10	2 X 4-1/2	48.61	CTC-1855574	P-UB-10	95 X 160	189.05
CTC-1721691	P-UB-10	3-1/2 X 5-1/2	171.89	CTC-1856582	P-UB-10	1-1/2 X 2-3/4	111.46
CTC-1721692	P-UB-10	4 X 4-1/2	182.67	CTC-1856583	P-UB-10	1-1/2 X 3	45.80
CTC-1721693	P-UB-10	3-1/2 X 4-1/2	184.86	CTC-1856584	P-UB-10	1-1/2 X 4	44.46
CTC-1724223K	P-U-10	45 X 75 mm	50.29	CTC-1856585	P-UB-10	1-1/2 X 2-1/2	30.70
CTC-1725285	P-U-10	25 mm X 40 mm	57.03	CTC-1856586	P-UB-10	1-1/2 X 2-3/4	34.35
CTC-1728486	I-U-10	1-3/4 X 63 mm	66.64	CTC-1856587	P-UB-10	1-1/2 X 3	60.74
CTC-1728487	I-U-10	50 mm X 70 mm	54.50	CTC-1856588	P-UB-10	1-1/2 X 3-1/2	64.71
CTC-1728500	P-UB-10	105 X 180 mm	363.39	CTC-1856589	P-UB-10	1-1/2 X 3-1/2	62.97
CTC-1744715K	P-UB-10	3-1/4 X 9-1/4	202.63	CTC-1856590	P-UB-10	1-1/2 X 2-1/4	30.56
CTC-1749425	P-UB-10	3-1/2 X 6-1/4	236.62	CTC-1856591	P-UB-10	1-1/2 X 3-1/2	131.03
CTC-1756855K	P-UB-10	100 X 140 mm	177.66	CTC-1856593	P-UB-10	1-1/2 X 3-1/4	40.55
CTC-1764912	P-UB-10	85 X 120 mm	264.41	CTC-1856596	P-UB-10	1-1/2 X 2-3/4	46.32
CTC-1764913	P-UB-10	100 X 140 mm	332.73	CTC-1856598	P-UB-10	1-1/2 X 3	28.37
CTC-1764914	P-UB-10	90 X 130 mm	141.89	CTC-1856601	P-UB-10	1-1/2 X 2-1/2	51.77
CTC-1764934	P-UB-10	85 X 120 mm	232.55	CTC-1857018	P-UB-10	1-3/4 X 3-1/2	59.85
CTC-1764935	P-UB-10	65 X 100 mm	221.28	CTC-1857019	P-UB-10	1-3/4 X 3-1/4	32.09
CTC-1764999	P-UB-10	95 X 130 mm	240.32	CTC-1857020	P-UB-10	1-3/4 X 3-1/2	68.69
CTC-1771958	P-U-10	32 mm X 63 mm	69.13	CTC-1857021	P-UB-10	1-3/4 X 4	29.68
CTC-1787189	I-U-10	36 X 65 mm	220.50	CTC-1857022	P-UB-10	1-3/4 X 3	25.72
CTC-1788382	P-UB-10	100 X 170 mm	372.09	CTC-1857023	P-UB-10	1-3/4 X 3-3/4	31.83
CTC-1791715	I-U-3	3/4 X 1-1/2	15.10	CTC-1857024	P-UB-10	1-3/4 X 2-3/4	55.04
CTC-1791749	I-O-3	3/4 X 1-1/2	5.39	CTC-1857025	P-UB-10	1-3/4 X 3	49.97
CTC-1794969K	P-U-10	45 X 75 mm	60.08	CTC-1857026	P-UB-10	1-3/4 X 2-1/2	103.56
CTC-1799625	P-UB-10	80 X 110 mm	251.75	CTC-1857027	P-UB-10	1-3/4 X 2-3/4	29.09
CTC-1799634	P-UB-10	85 X 120 mm	139.80	CTC-1857029	P-UB-10	1-3/4 X 4	133.72
CTC-1799638	P-UB-10	70 X 100 mm	97.72	CTC-1857030	P-UB-10	1-3/4 X 3-1/4	101.91

**CATERPILLAR®**





# REPLACEMENT KITS FOR CATERPILLAR® EQUIPMENT

**NOTE:** CATERPILLAR® kit numbers are used as a reference only. We do not imply that these kits are original REPLACEMENT KITS.

Kit Number	Code (Pg. xviii)	Rod X Bore Size	List Price
CTC-1857033	P-UB-10	1-3/4 X 3-3/4	\$129.60
CTC-1857035	P-UB-10	1-3/4 X 2-3/4	112.08
CTC-1857036	P-UB-10	1-3/4 X 2-1/2	144.29
CTC-1857037	P-UB-10	1-3/4 X 3	104.33
CTC-1857666	P-UB-10	2 X 4	51.72
CTC-1857667	P-UB-10	2 X 3	84.68
CTC-1857668	P-V-10	2 X 5	151.95
CTC-1857669	P-UB-10	2 X 4-1/4	48.34
CTC-1857670	P-UB-10	2 X 3-1/4	41.27
CTC-1857671	P-UB-10	2 X 4-1/2	45.91
CTC-1857672	P-UB-10	2 X 3-1/2	70.56
CTC-1857674	P-UB-10	2 X 3-1/2	115.51
CTC-1857675	P-UB-10	2 X 3-3/4	120.68
CTC-1857676	P-UB-10	2 X 5	59.42
CTC-1857677	P-UB-10	2 X 4	38.85
CTC-1857678	P-UB-10	2 X 3-1/2	70.81
CTC-1857680	P-V-10	2 X 4	56.26
CTC-1857681	P-U-10	2 X 3-1/2	107.69
CTC-1857682	P-UB-10	2 X 4-1/4	60.46
CTC-1857683	P-UB-10	2 X 3-1/4	44.20
CTC-1857684	P-UB-10	2 X 3-3/4	43.95
CTC-1857686	I-UB-10	2 X 4	91.22
CTC-1857687	N-UB-10	2 X 4	143.28
CTC-1857688	P-UB-10	2 X 4	69.64
CTC-1857689	P-UB-10	2 X 4-1/2	136.52
CTC-1857696	P-UB-10	2 X 4-1/4	44.88
CTC-1857698	P-UB-10	2 X 4	54.58
CTC-1857699	I-UB-10	2 X 4-1/2	215.23
CTC-1857700	P-UB-10	2 X 4-1/2	97.13
CTC-1859502	P-UB-10	2-1/4 X 5	59.59
CTC-1859503	P-UB-10	2-1/4 X 3-1/2	137.55
CTC-1859504	P-UB-10	2-3/4 X 4-1/2	54.82
CTC-1859505	P-UB-10	2-1/4 X 4-1/2	44.01
CTC-1859507	P-UB-10	2-1/4 X 4-1/4	111.10
CTC-1859508	P-UB-10	2-1/4 X 4	109.46
CTC-1859509	P-UB-10	2-1/4 X 3-3/4	110.54
CTC-1859510	P-UB-10	2-1/4 X 4	114.00
CTC-1859511	P-UB-10	2-1/4 X 4-3/4	122.56
CTC-1859512	P-UB-10	2-1/4 X 3-1/2	111.99
CTC-1859517	P-UB-10	2-1/4 X 4-1/4	133.49
CTC-1859519	P-UB-10	2-1/4 X 4-3/4	144.96
CTC-1859523	P-UB-10	2-1/4 X 4-1/2	52.85
CTC-1859525	P-UB-10	2-1/4 X 4-1/2	137.23
CTC-1859526	P-UB-10	2-1/4 X 3-1/2	174.98
CTC-1859527	P-UB-10	2-1/4 X 4	114.63
CTC-1859528	P-UB-10	2-1/4 X 3-3/4	132.77
CTC-1859530	P-UB-10	2-1/4 X 4-1/2	140.30
CTC-1859532	P-UB-10	2-1/4 X 4-1/2	171.29
CTC-1859534	P-UB-10	2-1/4 X 4-3/4	171.40
CTC-1859535	P-UB-10	2-1/4 X 4	89.72
CTC-1864327	I-UB-10	2-1/2 X 3-1/2	69.65

Kit Number	Code (Pg. xviii)	Rod X Bore Size	List Price
CTC-1864328	P-UB-10	2-1/2 X 4-1/4	\$108.94
CTC-1864329	P-UB-10	2-1/2 X 5-1/2	198.65
CTC-1864330	P-UB-10	2-1/2 X 6	241.04
CTC-1864331	P-UB-10	2-1/2 X 6-1/2	242.09
CTC-1864332	P-UB-10	2-1/2 X 5	73.15
CTC-1864333	P-UB-10	2-1/2 X 4	60.59
CTC-1864334	P-UB-10	2-1/2 X 7-1/4	134.67
CTC-1864335	P-UB-10	2-1/2 X 6	236.41
CTC-1864336	P-UB-10	2-1/2 X 4-1/4	90.63
CTC-1864337	P-UB-10	2-1/2 X 4-1/4	50.00
CTC-1864338	P-UB-10	2-1/2 X 4	81.62
CTC-1864339	P-UB-10	2-1/2 X 6-1/2	199.32
CTC-1864340	P-UB-10	2-1/2 X 6	104.10
CTC-1864341	P-UB-10	2-1/2 X 3-3/4	54.68
CTC-1864342	P-UB-10	2-1/2 X 5-1/2	162.54
CTC-1864349	P-U-10	2-1/2 X 6	100.89
CTC-1864350	P-UB-10	2-1/2 X 4-3/4	119.16
CTC-1864351	P-UB-10	2-1/2 X 6	134.57
CTC-1864356	P-UB-10	2-1/2 X 5-1/2	178.50
CTC-1864357	P-UB-10	2-1/2 X 6-1/2	93.83
CTC-1864358	P-U-10	2-1/2 X 5-1/2	54.69
CTC-1864362	P-UB-10	2-1/2 X 4-1/2	73.04
CTC-1864363	P-UB-10	2-1/2 X 5	81.08
CTC-1864365	P-UB-10	2-1/2 X 5	70.47
CTC-1864366	P-UB-10	2-1/2 X 5	183.27
CTC-1864368	P-UB-10	2-1/2 X 6	75.09
CTC-1864369	P-UB-10	2-1/2 X 3-3/4	132.45
CTC-1864371	P-UB-10	2-1/2 X 4	128.84
CTC-1864373	P-UB-10	2-1/2 X 4-1/4	102.61
CTC-1864375	P-UB-10	2-1/2 X 5-1/2	189.88
CTC-1864378	P-UB-10	2-1/2 X 4-3/4	88.82
CTC-1864380	P-UB-10	2-1/2 X 4	167.74
CTC-1864381	P-UB-10	2-1/2 X 4-3/4	155.36
CTC-1864382	P-UB-10	2-1/2 X 4-3/4	94.88
CTC-1864383	P-UB-10	2-1/2 X 5	146.37
CTC-1864386	P-UB-10	2-1/2 X 6-1/2	78.14
CTC-1864388	P-UB-10	2-1/2 X 6-1/2	172.86
CTC-1864391	P-UB-10	2-1/2 X 4-1/2	79.98
CTC-1864392	P-UB-10	2-1/2 X 4	178.37
CTC-1864393	P-UB-10	2-1/2 X 7-1/4	183.83
CTC-1864394	P-UB-10	2-1/2 X 4-3/4	173.95
CTC-1864396	P-UB-10	2-1/2 X 5-1/2	200.50
CTC-1864397	P-UB-10	2-1/2 X 5-1/4	191.82
CTC-1864398	P-UB-10	2-1/2 X 6-1/2	201.43
CTC-1864399	P-UB-10	2-1/2 X 4-3/4	84.06
CTC-1864404	P-UB-10	2-1/8 X 4	99.60
CTC-1864405	P-UB-10	2-3/8 X 4-1/4	137.83
CTC-1864406	P-UB-10	2-1/8 X 3-1/2	151.63
CTC-1882445K	P-UB-10	3-1/2 X 9-1/4	247.28
CTC-1884219	P-UB-10	105 X 150 mm	162.21
CTC-1884457	P-UB-10	95 X 160 mm	219.32

**CATERPILLAR®**

# REPLACEMENT KITS FOR CATERPILLAR® EQUIPMENT

**NOTE:** CATERPILLAR® kit numbers are used as a reference only. We do not imply that these kits are original REPLACEMENT KITS.

**CATERPILLAR®**

Kit Number	Code (Pg. xviii)	Rod X Bore Size	List Price	Kit Number	Code (Pg. xviii)	Rod X Bore Size	List Price
CTC-1890263	P-UB-10	3-1/2 X 5-1/2	\$245.88	CTC-1917753K	P-UB-10	2-3/8 X 4-1/2	\$ 82.09
CTC-1890264	P-UB-10	3-1/4 X 8-1/4	139.16	CTC-1917835K	I-UB-10	2-3/4 X 3-3/4	80.57
CTC-1890267	P-UB-10	3-1/2 X 8-1/4	264.33	CTC-1917839K	I-UB-10	2-3/4 X 3-3/4	80.61
CTC-1890268	P-U-10	2-3/4 X 5	76.77	CTC-1917846K	P-UB-10	2-3/8 X 4-3/4	100.47
CTC-1890269	P-UB-10	3 X 6-1/2	179.85	CTC-1918161K	P-UB-10	2 X 4	46.75
CTC-1890271	P-UB-10	2-3/8 X 3-3/4	52.87	CTC-1919203	P-UB-10	3 X 6-1/4	155.54
CTC-1890273	P-UB-10	3 X 4	209.38	CTC-1919204	P-UB-10	3 X 6	162.79
CTC-1890281	P-UB-10	100 X 140 mm	402.70	CTC-1919207	P-UB-10	3-1/4 X 9-1/4	243.56
CTC-1890282	P-UB-10	100 x 140 mm	290.08	CTC-1919208	P-UB-10	4 X 6-1/2	458.88
CTC-1895369	P-UB-10	3-1/4 X 7	200.38	CTC-1919209	P-UB-10	3-1/4 X 9-1/4	270.42
CTC-1895370	P-UB-10	3-1/4 X 7	229.57	CTC-1919212	P-UB-10	3 X 6	171.87
CTC-1895371	P-UB-10	3-1/4 X 7	264.76	CTC-1919214	P-UB-10	3-1/4 X 6-1/2	239.04
CTC-1895373	P-UB-10	3-1/4 X 8-1/4	168.40	CTC-1919216	P-UB-10	4 X 6-1/2	427.72
CTC-1895374	P-UB-10	3-1/4 X 7	108.13	CTC-1919605	P-U-10	45 mm X 60 mm	71.53
CTC-1895375	P-UB-10	3-1/4 X 7	148.90	CTC-1920738	P-UB-10	3-1/4 X 5-1/2	183.34
CTC-1895377	P-UB-10	3-1/4 x 9-1/4	241.10	CTC-1920739	P-UB-10	3-1/4 X 7-1/4	166.15
CTC-1895378	P-UB-10	3-1/4 X 9-1/4	230.01	CTC-1920740	P-UB-10	3-1/4 X 7-1/4	221.33
CTC-1895379	P-UB-10	3-1/4 X 9-1/4	246.13	CTC-1920742	P-UB-10	3 X 4-3/4	367.78
CTC-1895381	P-UB-10	3-1/4 X 5-1/2	144.32	CTC-1920743	P-UB-10	3 X 5-1/4	332.01
CTC-1895383	P-UB-10	3-1/4 X 8-1/4	277.86	CTC-1920891K	P-UB-10	1-1/2 X 3	48.71
CTC-1895384	P-UB-10	3-1/4 X 7-3/4	180.79	CTC-1920893K	P-UB-10	1-1/2 X 3	48.71
CTC-1895386	P-UB-10	3-1/4 X 7-1/4	264.33	CTC-1921409	P-UB-10	3 X 7-1/4	167.15
CTC-1905431	P-UB-10	3-1/4 X 8-1/4	208.07	CTC-1921411	P-UB-10	3 X 4-1/2	371.62
CTC-1905432	P-UB-10	3-1/4 X 9-1/4	346.46	CTC-1922811K	P-UB-10	2-1/4 X 4-1/2	73.70
CTC-1905955K	P-UB-10	3-1/2 X 9-1/4	247.28	CTC-1923003	P-UB-10	3 X 8-1/4	307.44
CTC-1908141	P-UB-10	2-1/2 X 4-1/2	182.16	CTC-1923006	P-UB-10	3 X 5-1/4	197.20
CTC-1912322	P-UB-10	3 X 5-1/2	120.05	CTC-1923007	P-UB-10	3 X 4-3/4	177.92
CTC-1912430	P-U-10	3 X 6-1/2	130.09	CTC-1923008	P-UB-10	3 X 4-3/4	155.11
CTC-1912432	P-UB-10	3 X 6-1/2	105.58	CTC-1923009	P-UB-10	2-3/4 X 6-1/4	243.19
CTC-1912433	P-UB-10	3 X 7-1/4	224.01	CTC-1923010	P-UB-10	3 X 5-1/4	133.54
CTC-1912434	P-UB-10	3 X 7-1/4	133.57	CTC-1923791K	P-UB-10	2 X 85 mm	138.08
CTC-1913170	P-UB-10	110 X 170 mm	479.92	CTC-1923884K	P-UB-10	2 X 85 mm	68.56
CTC-1913171	P-UB-10	110 X 170	240.39	CTC-1924110K	P-UB-10	2 X 85 mm	138.48
CTC-1913564	P-UB-10	3 X 6-1/2	98.38	CTC-1926445K	P-UB-10	3-1/2 X 9-1/4	264.37
CTC-1913565	P-UB-10	3 X 6-1/2	121.64	CTC-1926446K	P-UB-10	3-1/2 X 9-1/4	264.37
CTC-1915027	I-U-10	2-3/4 X 4	117.42	CTC-1932344	P-UB-10	3-1/2 X 6	267.51
CTC-1915028	P-UB-10	3 X 4-3/4	112.57	CTC-1932345	P-UB-10	3 X 5-1/4	157.24
CTC-1915029	P-UB-10	3 X 4-3/4	367.78	CTC-1932346	P-UB-10	3-1/2 X 6	305.44
CTC-1915030	P-UB-10	3 X 4-3/4	162.01	CTC-1932347	P-UB-10	3 X 5	184.45
CTC-1915031	P-UB-10	3 X 6	133.88	CTC-1932348	P-UB-10	3 X 7	257.92
CTC-1915551K	P-UB-10	115 X 170	281.62	CTC-1933088	P-UB-10	1-7/8 X 3-1/4	87.60
CTC-1915619	P-UB-10	105 X 150 mm	162.21	CTC-1933089	P-UB-10	2-3/4 X 5	129.02
CTC-1915649	P-UB-10	115 X 170	317.73	CTC-1933090	P-UB-10	2-3/4 X 6-1/2	195.58
CTC-1916508	P-UB-10	3 X 7-1/4	157.30	CTC-1933091	P-UB-10	2-3/4 X 7-1/4	157.65
CTC-1916511	P-UB-10	3 X 7-1/4	172.80	CTC-1933092	P-UB-10	2-3/4 X 6-1/2	82.40
CTC-1917692	P-UB-10	3 X 6-1/4	166.67	CTC-1933093	P-UB-10	2-3/4 X 5-1/2	163.38
CTC-1917693	P-UB-10	3-1/4 X 9-1/4	317.61	CTC-1933094	P-UB-10	2-3/4 X 7	250.59
CTC-1917694	P-UB-10	3 X 6-1/4	217.44	CTC-1933096	P-UB-10	3-1/2 X 7-1/2	277.92
CTC-1917696	P-UB-10	3-1/4 X 9-1/4	359.30	CTC-1933097	P-UB-10	2-3/4 X 6-1/2	96.35
CTC-1917721K	P-UB-10	1-1/2 X 3	41.48	CTC-1933098	P-UB-10	4 X 10	230.82
CTC-1917725K	P-UB-10	1-1/2 X 3	41.48	CTC-1933102	P-UB-10	4 X 9-1/4	315.06



# REPLACEMENT KITS FOR CATERPILLAR® EQUIPMENT

**NOTE:** CATERPILLAR® kit numbers are used as a reference only. We do not imply that these kits are original REPLACEMENT KITS.

Kit Number	Code (Pg. xviii)	Rod X Bore Size	List Price
CTC-1933104	P-UB-10	2-3/4 X 6-1/2	\$227.62
CTC-1933106	P-UB-10	2-3/4 X 5-1/2	215.55
CTC-1933108	P-UB-10	2-3/4 X 7	269.45
CTC-1933112	P-UB-10	4 X 9-1/4	234.83
CTC-1933114	P-UB-10	2-3/4 X 7-1/4	230.89
CTC-1933115	P-UB-10	3-1/2 X 8-1/2	356.65
CTC-1933116	P-UB-10	3-1/2 X 7-3/4	151.44
CTC-1933117	P-UB-10	2-3/4 X 4-1/2	111.56
CTC-1934321	P-U-10	50 X 85 mm	134.80
CTC-1934322	P-U-10	50 X 90 mm	89.08
CTC-1934323	P-U-10	45 X 75 mm	72.88
CTC-1934324	P-U-10	50 X 100 mm	127.36
CTC-1934325	P-U-10	50 X 80 mm	116.11
CTC-1935427	P-UB-10	2-3/4 X 6	94.00
CTC-1935428	P-UB-10	2-3/4 X 7-1/4	178.51
CTC-1935431	P-UB-10	2-1/8 X 4	87.60
CTC-1935433	P-UB-10	3-1/2 X 8-1/4	209.96
CTC-1935438	P-UB-10	2-3/4 X 6	67.62
CTC-1935440	P-UB-10	2-3/4 X 7-1/4	251.45
CTC-1937619	P-UB-10	2-3/4 X 5	173.15
CTC-1937620	P-UB-10	2-3/4 X 4-1/4	86.07
CTC-1937621	P-UB-10	2-3/4 X 5-1/2	140.58
CTC-1937622	P-UB-10	3-1/2 X 7-1/2	151.60
CTC-1937623	P-UB-10	2-3/4 X 6	148.48
CTC-1937624	P-UB-10	2-3/4 X 6-1/2	158.30
CTC-1937626	P-UB-10	1-7/8 X 3	201.59
CTC-1937628	P-UB-10	3-1/2 X 8-1/4	316.04
CTC-1937629	P-UB-10	2-3/4 X 4-1/4	148.77
CTC-1937630	P-UB-10	2-3/4 X 5-1/2	198.70
CTC-1937631	P-UB-10	2-3/4 X 5-1/2	213.29
CTC-1937633	P-UB-10	3-1/2 X 7-1/2	239.62
CTC-1937635	P-UB-10	3-1/2 X 6-1/4	240.08
CTC-1937637	P-UB-10	3-1/2 X 8-1/4	278.31
CTC-1937639	P-UB-10	2-3/4 X 5-1/2	120.11
CTC-1937852K	P-U-10	45 X 75 mm	72.93
CTC-1937855K	P-U-10	45 X 80 mm	63.28
CTC-1937859K	P-U-10	45 X 85 mm	74.18
CTC-1939260	P-UB-10	4 X 8-1/2	346.20
CTC-1939261	P-UB-10	2-3/4 X 6	239.06
CTC-1939264	P-UB-10	3-1/2 X 7-1/4	174.13
CTC-1939265	P-UB-10	3-1/2 X 4-1/2	274.21
CTC-1939267	P-UB-10	2-3/4 X 6	167.70
CTC-1939269	P-UB-10	2-3/4 X 5-1/2	122.19
CTC-1939270	I-UB-10	2-3/4 X 3-3/4	101.82
CTC-1942756	P-UB-10	3-1/2 X 4-1/2	330.57
CTC-1944396	P-UB-10	4 X 4-1/2	243.97
CTC-1944397	P-UB-10	2-3/4 X 4	165.38
CTC-1944398	P-UB-10	4 X 4-1/2	229.55
CTC-1944399	P-UB-10	3-1/2 X 4-1/2	244.46
CTC-1945583	P-UB-10	2-3/8 X 4-1/2	81.63
CTC-1945586	P-UB-10	3-1/2 X 10-1/2	363.27

Kit Number	Code (Pg. xviii)	Rod X Bore Size	List Price
CTC-1945587	P-UB-10	3-1/2 X 8-1/4	\$189.77
CTC-1945588	P-UB-10	7 X 11	849.80
CTC-1945591	P-UB-10	4-1/4 X 6-1/2	539.84
CTC-1945593	P-V-10	1-1/4 X 4	128.98
CTC-1945600	P-UB-10	2-3/8 X 4	56.42
CTC-1945603	I-UB-10	2-3/4 X 3-3/4	87.45
CTC-1945604	P-UB-10	2-1/8 X 4	162.43
CTC-1945606	P-UB-10	4-1/4 X 7-3/4	254.94
CTC-1945608	P-UB-10	4 X 8-1/2	281.04
CTC-1945614	I-UB-10	2-1/2 X 3-1/2	186.12
CTC-1948235	P-UB-10	110 X 160	236.66
CTC-1948363	P-UB-10	100 X 140 mm	402.42
CTC-1948366	P-UB-10	105 X 150 mm	374.90
CTC-1948396	P-UB-10	110 X 160	211.79
CTC-1964523K	P-UB-10	2 X 85 mm	138.52
CTC-1978079K	P-UB-10	2-1/2 X 4	49.22
CTC-1978083K	P-UB-10	2-1/2 X 4	49.22
CTC-1980648K	I-U-10	45 X 60	46.82
CTC-1987021K	P-U-10	50 X 80 mm	116.14
CTC-1989433	P-U-10	55 X 100 mm	87.39
CTC-1990609	P-U-10	55 X 85 mm	82.94
CTC-1991149	P-U-10	45 X 75 mm	69.90
CTC-1992097	P-U-10	50 X 90 mm	96.48
CTC-1992402	P-U-10	55 X 100 mm	88.93
CTC-1997416	P-UB-10	105 X 150 mm	206.20
CTC-1997417	P-UB-10	110 X 170	223.14
CTC-1U1839K	P-UB-10	2-1/4 X 3-3/4	56.57
CTC-2000920	P-U-10	70 mm X 130 mm	149.74
CTC-2003239	P-UB-10	75 X 120 mm	83.47
CTC-2003240	P-UB-10	70 X 100 mm	96.30
CTC-2003242	P-UB-10	55 X 100 mm	141.17
CTC-2003315	P-UB-10	105 X 150 mm	162.21
CTC-2003361	P-UB-10	75 X 130 mm	197.97
CTC-2003497	P-UB-10	150 X 220 mm	644.90
CTC-2003498	P-UB-10	130 X 190	312.88
CTC-2003499	P-UB-10	130 X 180	303.49
CTC-2003572	P-UB-10	110 mm X 160 mm	233.92
CTC-2003621	P-UB-10	130 X 190 mm	570.84
CTC-2007128K	P-UB-10	2 X 4	46.79
CTC-2011056K	P-UB-10	1-1/2 X 2-3/4	43.33
CTC-2014838	P-UB-10	3 X 4-3/4	334.26
CTC-2022263	P-UB-10	100 X 140 mm	437.63
CTC-2022264	P-UB-10	105 X 150 mm	487.44
CTC-2027897	I-U-5	40 mm X 60 mm	41.35
CTC-2037172K	P-U-10	40 X 65 mm	45.53
CTC-2041129	P-UB-10	1-3/4 X 3-1/2	150.96
CTC-2042718K	P-UB-14	60 X 90 mm	153.88
CTC-2042721	P-UB-10	110 X 160	232.22
CTC-2043398	P-UB-10	2-1/2 X 4-1/2	197.54
CTC-2043616	P-UB-10	100 X 140	154.13
CTC-2043625	P-UB-10	85 X 120 mm	238.21

CATERPILLAR®



# REPLACEMENT KITS FOR CATERPILLAR® EQUIPMENT

**NOTE:** CATERPILLAR® kit numbers are used as a reference only. We do not imply that these kits are original REPLACEMENT KITS.

**CATERPILLAR®**

Kit Number	Code (Pg. xviii)	Rod X Bore Size	List Price	Kit Number	Code (Pg. xviii)	Rod X Bore Size	List Price
CTC-2043626	P-UB-10	100 X 140 mm	\$306.21	CTC-2126336K	P-U-10	45 X 75 mm	\$ 50.29
CTC-2043627	P-UB-10	85 X 120	139.85	CTC-2126337K	P-U-10	45 X 75 mm	54.83
CTC-2043628	P-UB-10	85 X 125	150.49	CTC-2138433	I-U-10	2-1/2 X 5	12.48
CTC-2043629	P-UB-10	90 X 130 mm	271.38	CTC-2144502	P-UB-10	100 X 140	154.13
CTC-2043630	P-UB-10	90 X 130 mm	253.12	CTC-2146321	P-UB-10	100 X 140 mm	451.00
CTC-2043692	P-UB-10	85 X 120	148.20	CTC-2147581	P-UB-10	100 X 140 mm	438.69
CTC-2044910K	P-UB-10	90 X 130	137.51	CTC-2149170	P-UB-10	3-1/4 X 8-1/4	169.68
CTC-2044912K	P-UB-10	100 X 140	176.23	CTC-2159896K	P-UB-14	60 X 90 mm	153.88
CTC-2044914K	P-UB-10	90 X 130	113.53	CTC-2159984	P-UB-10	95 mm X 130 mm	108.57
CTC-2058655K	P-UB-10	2-3/4 X 5-3/8	143.54	CTC-2159985	P-UB-10	100 X 140 mm	122.51
CTC-2058656K	P-UB-10	2-1/2 X 4-3/4	140.07	CTC-2159986	P-UB-10	90 X 130	125.06
CTC-2058668	P-UB-10	3 X 7-1/4	244.80	CTC-2159988	P-UB-10	110 X 160	199.79
CTC-2060503K	P-UB-10	2-1/2 X 4-1/2	55.17	CTC-2159989	P-UB-10	110 X 160 mm	254.70
CTC-2060520K	P-UB-10	2-1/8 X 4	100.01	CTC-2159990	P-UB-10	110 X 170	221.32
CTC-2060522K	P-UB-10	2-1/8 X 4	100.01	CTC-2159995	P-UB-10	140 X 200	379.27
CTC-2062857	P-UB-10	3-1/4 X 5-1/2	425.64	CTC-2159996	P-UB-10	130 mm X 180 mm	286.03
CTC-2063553K	P-UB-10	1-7/8 X 3-1/4	44.94	CTC-2167247	P-U-10	55 X 100 mm	134.69
CTC-2063555K	P-UB-10	2 X 85 mm	138.52	CTC-2167388K	P-UB-10	1-1/2 X 2-3/4	43.33
CTC-2063628K	P-UB-10	2-3/8 X 4-1/2	63.73	CTC-2167644	P-U-10	50 X 85 mm	216.71
CTC-2063805	P-U-10	45 mm X 65 mm	98.23	CTC-2168100	P-U-10	45 X 70 mm	189.95
CTC-2089504	P-UB-10	105 X 150 mm	129.42	CTC-2171643	P-U-10	55 X 85 mm	221.81
CTC-2089506	P-UB-10	140 X 200 mm	573.18	CTC-2179894	P-UB-10	55 mm X 4-1/2	122.09
CTC-2089508	P-UB-10	100 X 140 mm	407.60	CTC-2186822	P-U-10	35 mm X 70 mm	73.84
CTC-2089509	P-UB-10	90 X 130 mm	390.60	CTC-2186823	P-U-10	40 mm X 60 mm	59.26
CTC-2092101	P-UB-10	3 X 5-1/2	192.61	CTC-2186824	P-U-10	45 mm X 65 mm	51.03
CTC-2094979	P-UB-10	1-7/8 X 3-1/4	45.18	CTC-2186825	P-U-10	30 mm X 65 mm	51.44
CTC-2095873	P-UB-10	90 X 130 mm	387.66	CTC-2186826	P-U-10	35 mm X 50 mm	38.07
CTC-2095874	P-UB-10	100 X 140 mm	254.03	CTC-2186827	P-U-10	45 mm X 60 mm	57.43
CTC-2101427	P-UB-10	90 X 160 mm	408.28	CTC-2190541K	P-U-10	40 X 65 mm	45.53
CTC-2106150	P-UB-10	105 X 150 mm	485.38	CTC-2191322	P-U-5	40 mm X 70 mm	34.53
CTC-2106151	P-UB-10	105 X 150 mm	487.44	CTC-2199066	P-U-10	55 X 95 mm	160.72
CTC-2107076K	P-UB-10	2-3/8 X 4-3/4	101.55	CTC-2222376	P-UB-10	65 mm X 100 mm	152.97
CTC-2107077K	P-UB-10	2-1/4 X 4-1/4	58.61	CTC-2235944	I-UB-10	2-3/4 X 3-3/4	79.23
CTC-2107078K	P-UB-10	2-1/4 X 4-1/4	56.23	CTC-2235945	I-UB-10	2-1/2 X 3-1/2	66.26
CTC-2107081K	P-UB-10	2-1/2 X 4-3/4	171.33	CTC-2254625	P-UB-10	110 X 160	269.79
CTC-2107082K	P-UB-10	2-1/2 X 4-3/4	169.49	CTC-2254646	P-UB-10	130 X 190	321.61
CTC-2107085K	I-UB-10	2-3/8 X 85 mm	59.46	CTC-2256727K	P-UB-10	3 X 4-3/4	131.20
CTC-2107086K	I-UB-10	2-3/8 X 85 mm	70.10	CTC-2269959K	P-U-10	35 X 65 mm	38.86
CTC-2107087K	I-UB-10	2-1/2 X 3-1/2	36.23	CTC-2270841K	P-UB-10	2-1/2 X 6	72.89
CTC-2107088K	I-UB-10	2-1/2 X 3-1/2	33.54	CTC-2270842K	P-UB-10	2-1/2 X 5	76.20
CTC-2107091K	P-UB-10	2-1/2 X 5	75.43	CTC-2270843K	P-UB-10	2-1/2 X 4	90.84
CTC-2107092K	P-UB-10	2-1/2 X 5	72.78	CTC-2270844K	P-UB-10	2-1/2 X 4	90.84
CTC-2107096K	I-UB-10	2-3/4 X 3-3/4	84.29	CTC-2270994K	P-UB-10	2-1/2 X 4	177.35
CTC-2107097K	P-UB-10	1-1/2 X 3	40.66	CTC-2275347	P-UB-10	2-1/2 X 5	93.84
CTC-2107098K	P-UB-10	1-1/2 X 3	38.29	CTC-2275348	P-UB-10	2-3/4 X 4-1/2	120.33
CTC-2110620	P-UB-10	2-1/2 X 5-1/4	188.76	CTC-2275349	P-UB-10	3 X 4-3/4	194.23
CTC-2118742	P-UB-10	2-1/2 X 4	168.72	CTC-2275350	P-UB-10	1-3/4 X 3	33.45
CTC-2119614	P-UB-10	90 X 130	157.94	CTC-2278893K	P-UB-10	2-1/2 X 5-1/4	80.61
CTC-2126328K	P-U-10	35 X 65 mm	38.86	CTC-2280320K	P-UB-10	2 X 4	70.57
CTC-2126329K	P-U-10	40 X 70 mm	43.71	CTC-2280806	P-UB-10	3 X 7	290.85
CTC-2126335K	P-U-10	45 X 75 mm	50.29	CTC-2280807	P-UB-10	3 X 6-1/4	266.23



# REPLACEMENT KITS FOR CATERPILLAR® EQUIPMENT

**NOTE:** CATERPILLAR® kit numbers are used as a reference only. We do not imply that these kits are original REPLACEMENT KITS.

Kit Number	Code (Pg. xviii)	Rod X Bore Size	List Price	Kit Number	Code (Pg. xviii)	Rod X Bore Size	List Price
CTC-2280808	P-UB-10	2-3/4 X 6-1/4	\$243.19	CTC-2342591	P-UB-10	2-1/4 X 4	\$ 64.51
CTC-2280809	P-UB-10	2-3/4 X 5-1/2	122.19	CTC-2342592	P-UB-10	1-1/2 X 2-1/2	123.90
CTC-2281775	P-UB-10	3-1/2 X 7-3/4	159.53	CTC-2342593	P-UB-10	1-7/8 X 3-1/4	63.49
CTC-2281776	P-UB-10	3 X 5-1/4	108.40	CTC-2342594	P-UB-10	1-3/4 X 3	39.38
CTC-2281778	P-UB-10	2 X 3-1/2	77.70	CTC-2342595	P-UB-10	1-3/4 X 2-3/4	150.78
CTC-2281779	P-UB-10	3-1/4 X 7	150.19	CTC-2344442	P-UB-10	110 X 170	238.85
CTC-2281780	P-UB-10	3-1/4 X 8-1/4	236.62	CTC-2344488	P-UB-10	95 X 135	268.59
CTC-2281792	P-UB-10	3-1/4 X 7	143.06	CTC-2344566	P-UB-10	100 X 140	146.21
CTC-2281793	P-UB-10	3 X 6	144.83	CTC-2344576	P-UB-10	105 X 150	335.81
CTC-2281795	P-UB-10	1-3/4 X 3-1/2	98.14	CTC-2344587	P-UB-10	95 X 135	134.16
CTC-2282533	P-UB-10	3-1/2 X 9-1/4	314.92	CTC-2344666	P-UB-10	140 mm X 200 mm	350.76
CTC-2285271	P-UB-10	2-1/2 X 4-3/4	80.32	CTC-2344667	P-UB-10	150 X 220 mm	661.44
CTC-2285272	P-UB-10	2-1/2 X 4-3/4	88.82	CTC-2344673	P-UB-10	130 mm X 180 mm	294.14
CTC-2285273	P-UB-10	2-1/2 X 5-1/2	83.28	CTC-2344674	P-UB-10	110 X 160 mm	220.73
CTC-2285274	P-UB-10	2-3/4 X 5-1/2	216.75	CTC-2350351	P-UB-10	1-3/4 X 2-3/4	145.01
CTC-2285275	P-UB-10	2-3/4 X 5-1/2	185.27	CTC-2350352	P-UB-10	1-3/4 X 2-3/4	100.66
CTC-2292626	P-UB-10	2-1/2 X 4	98.39	CTC-2350354	P-UB-10	1-1/2 X 3	34.36
CTC-2292758	P-UB-10	3 X 4-1/2	84.98	CTC-2350355	P-UB-10	2-1/4 X 3-1/2	160.41
CTC-2292968	P-UB-10	3 X 4-3/4	400.44	CTC-2350969	P-UB-10	2-1/4 X 3-3/4	169.68
CTC-2293635	P-UB-10	3-1/2 X 6-1/4	293.84	CTC-2350972	P-UB-10	2-3/8 X 4-1/2	178.36
CTC-2295507	P-UB-10	4 X 7	242.37	CTC-2350973	P-UB-10	2-3/8 X 4-3/4	153.76
CTC-2295538	P-UB-10	2-1/2 X 4	166.28	CTC-2355802	P-UB-10	2-3/4 X 6-1/2	72.63
CTC-2295546	P-UB-10	4-1/2 X 220 mm	369.67	CTC-2356823K	P-UB-10	2-1/2 X 4-1/2	55.85
CTC-2295549	P-UB-10	5" X 220 mm	502.74	CTC-2356824K	P-UB-10	2-3/4 X 6	110.71
CTC-2297173	P-UB-10	3-1/4 X 8-1/2	307.73	CTC-2359829K	P-UB-10	2-1/2 X 4-1/2	55.14
CTC-2297194	P-UB-10	2-1/2 X 4-1/2	55.17	CTC-2366368	P-UB-10	85 X 120	109.57
CTC-2304001	P-UB-10	110 X 180	262.70	CTC-2366389	P-U-10	85 X 120	109.57
CTC-2309267K	P-U-10	45 X 85 mm	80.28	CTC-2369769K	P-UB-10	3 X 4-3/4	100.39
CTC-2309357	I-U-10	1-1/2 X 3	55.43	CTC-2370946K	I-U-10	1 X 2	12.98
CTC-2310898	P-UB-10	2-1/2 X 4-1/2	75.41	CTC-2373542K	P-U-10	40 X 70 mm	43.71
CTC-2315021	I-UB-10	2-3/4 X 3-3/4	80.61	CTC-2374079K	P-U-10	40 X 70 mm	43.71
CTC-2316844	P-UB-10	115 X 170	317.73	CTC-2375448	P-UB-10	4" X 230 mm	402.89
CTC-2316845	P-UB-10	115 X 170	324.40	CTC-2378277	P-UB-10	2 X 4	51.62
CTC-2320652K	P-UB-10	4 X 9-1/4	279.06	CTC-2378313	P-UB-10	3 X 6	215.72
CTC-2320653K	P-UB-10	4 X 9-1/4	279.06	CTC-2379271K	P-UB-10	1-1/2 X 2-3/4	44.05
CTC-2320654K	P-UB-10	4 X 9-1/4	288.72	CTC-2384462	P-UB-10	2 X 3	44.84
CTC-2330478K	P-UB-10	2-1/2 X 4	177.35	CTC-2384487	P-V-10	2 X 5	56.25
CTC-2330761	P-UB-10	95 X 130 mm	456.76	CTC-2384501	P-UB-10	2 X 4-1/4	42.56
CTC-2330763	P-UB-10	100 X 170	224.74	CTC-2386661	P-UB-10	2 X 3-1/4	42.08
CTC-2330764	P-UB-10	95 X 160 mm	202.86	CTC-2386718	P-UB-10	2 X 4-1/2	41.39
CTC-2332622	P-UB-10	50 mm X 100 mm	62.22	CTC-2386859	P-UB-10	2 X 3-1/2	68.11
CTC-2332623	P-UB-10	55 mm X 100 mm	108.28	CTC-2386882	P-U-10	2 X 4-1/2	151.84
CTC-2332628	P-U-10	1-7/8 X 3-1/4	138.57	CTC-2390837K	P-U-10	40 X 65 mm	45.50
CTC-2339134K	P-UB-10	3 X 6-1/2	121.95	CTC-2401661	P-UB-10	1-3/4 X 3-1/2	79.37
CTC-2339204	P-UB-10	1-1/2 X 2-3/4	62.57	CTC-2401671	P-UB-10	1-3/4 X 3-1/4	37.47
CTC-2339205	P-UB-10	2 X 4	53.31	CTC-2401881	P-UB-10	1-3/4 X 3-1/2	71.98
CTC-2341948	P-UB-10	2-1/2 X 4-3/4	90.62	CTC-2401905	P-UB-10	1-3/4 X 4	103.49
CTC-2341949	P-UB-10	2-1/2 X 4	55.57	CTC-2402016	P-UB-10	1-3/4 X 3	41.53
CTC-2341950	P-UB-10	2-1/2 X 5-1/4	216.41	CTC-2402481	P-UB-10	1-3/4 X 3-3/4	45.24
CTC-2341951	P-UB-10	2-1/2 X 4-1/4	165.40	CTC-2402482	P-UB-10	1-3/4 X 2-3/4	41.09
CTC-2342590	P-UB-10	5-1/2 X 10-1/2	528.38	CTC-2402484	P-UB-10	1-3/4 X 2-1/2	110.65

**CATERPILLAR®**

# REPLACEMENT KITS FOR CATERPILLAR® EQUIPMENT

**NOTE:** CATERPILLAR® kit numbers are used as a reference only. We do not imply that these kits are original REPLACEMENT KITS.

**CATERPILLAR®**

Kit Number	Code (Pg. xviii)	Rod X Bore Size	List Price	Kit Number	Code (Pg. xviii)	Rod X Bore Size	List Price
CTC-2404713	P-UB-10	1-3/4 X 2-3/4	\$ 99.76	CTC-2422542	P-UB-10	2-1/2 X 5	\$ 80.81
CTC-2404819	P-UB-10	1-3/4 X 4	108.64	CTC-2422543	P-UB-10	2-1/1 X 4	60.26
CTC-2405500	P-UB-10	1-3/4 X 2-1/2	57.67	CTC-2422544	P-UB-10	2-1/2 X 7-1/4	81.07
CTC-2405524	P-UB-10	1-3/4 X 3	121.21	CTC-2422545	P-UB-10	2-1/2 X 6	237.13
CTC-2406029K	I-UB-10	2-3/4 X 3-3/4	74.12	CTC-2422546	P-UB-10	2-1/2 X 4-1/4	62.14
CTC-2406030K	I-UB-10	2-3/4 X 3-3/4	74.12	CTC-2422547	P-UB-10	2-1/2 X 4-1/4	57.23
CTC-2406869	P-UB-10	2 X 3-3/4	126.27	CTC-2422548	P-UB-10	2-1/2 X 4	57.65
CTC-2406883	P-UB-10	2 X 5	174.52	CTC-2422549	P-UB-10	2-1/2 X 6-1/2	88.50
CTC-2406899	P-UB-10	2 X 4	53.31	CTC-2422550	P-UB-10	2-1/2 X 6	108.38
CTC-2407308	P-UB-10	2 X 3-1/2	70.81	CTC-2422551	P-UB-10	2-1/2 X 3-3/4	54.68
CTC-2407347K	P-UB-10	3-1/2 X 7-1/4	185.41	CTC-2422552	P-U-10	2-1/2 X 6	175.44
CTC-2408479	P-U-10	2 X 5	162.23	CTC-2422553	P-U-10	2-1/2 X 5	82.02
CTC-2408513	P-V-10	2 X 4	164.38	CTC-2422554	P-U-10	2-1/2 X 6-1/2	184.56
CTC-2408515	P-U-10	2 X 3-1/2	107.69	CTC-2422556	P-U-10	2-1/2 X 6	90.93
CTC-2408523	P-UB-10	2 X 4-1/4	57.61	CTC-2422557	P-U-10	2-1/2 X 6	86.59
CTC-2408525	P-UB-10	2 X 3-1/4	46.19	CTC-2422558	P-UB-10	2-1/2 X 6	67.26
CTC-2409518	P-UB-10	2 X 3-3/4	156.99	CTC-2424270K	P-UB-10	3-1/4 X 6-1/4	210.06
CTC-2409538	P-UB-10	2 X 4	73.72	CTC-2424271K	P-UB-10	3-1/4 X 5-3/4	253.39
CTC-2409936	P-UB-10	2 X 4-1/2	140.73	CTC-2424272K	P-UB-10	3-1/4 X 5-3/4	253.39
CTC-2409939	P-UB-10	2 X 4-1/4	140.85	CTC-2424273K	P-UB-10	3-1/4 X 170 mm	218.79
CTC-2409941	P-UB-10	2 X 4	155.52	CTC-2426840	P-UB-10	105 X 150	175.50
CTC-2409942	P-UB-10	2 X 4-1/2	161.62	CTC-2426855K	P-UB-10	90 X 130 mm	115.57
CTC-2410108	P-U-10	2 X 4-3/4	157.64	CTC-2430381	P-UB-10	2-1/2 X 5-1/2	74.38
CTC-2410109	P-UB-10	2in x 75mm	91.25	CTC-2430382	P-UB-10	2-1/2 X 6-1/2	109.52
CTC-2410110	P-UB-10	2in x 85mm	123.40	CTC-2430383	P-UB-10	2-1/2 X 5-1/2	63.06
CTC-2410550K	P-UB-10	3-1/2 X 7-1/4	131.37	CTC-2430384	P-UB-10	2-1/2 X 5	81.08
CTC-2410895	P-UB-10	2-1/4 X 5	61.17	CTC-2430386	P-UB-10	2-1/2 X 5	70.47
CTC-2410896	P-UB-10	2-1/4 X 4-1/2	75.65	CTC-2430387	P-UB-10	2-1/2 X 5	208.35
CTC-2410897	P-UB-10	2-1/4 X 4-1/2	46.18	CTC-2430389	P-UB-10	2-1/2 X 3-3/4	152.51
CTC-2410898	P-UB-10	2-1/4 X 4-1/4	56.66	CTC-2430391	P-UB-10	2-1/2 X 4	67.35
CTC-2410899	P-UB-10	2-1/4 X 4	139.01	CTC-2430393	P-UB-10	2-1/2 X 4-1/4	187.14
CTC-2410900	P-UB-2	2-1/4 X 3-3/4	40.85	CTC-2430395	P-UB-10	2-1/2 X 5-1/2	211.72
CTC-2410901	P-UB-10	2-1/4 X 4	55.47	CTC-2430397	P-UB-10	2-1/2 X 4	113.43
CTC-2410902	P-UB-10	2-1/4 X 4-3/4	77.24	CTC-2430398	P-UB-10	2-1/2 X 4-3/4	178.91
CTC-2410903	P-UB-10	2-1/4 X 3-1/2	77.38	CTC-2432058K	P-UB-10	1-3/4 X 3-1/2	75.02
CTC-2417578	P-UB-10	2-1/4 X 5	63.66	CTC-2432276	P-U-10	50 mm X 85 mm	83.04
CTC-2417579	P-UB-10	2-1/4 X 4-1/4	174.47	CTC-2435796	P-UB-10	2-1/2 X 6-1/2	76.59
CTC-2417580	P-UB-10	2-1/4 X 4-3/4	166.36	CTC-2435797	P-UB-10	2-1/2 X 6-1/2	206.43
CTC-2417584	P-UB-10	2-1/4 X 4-1/2	75.10	CTC-2435798	P-UB-10	2-1/2 X 4-1/2	75.64
CTC-2417585	P-UB-10	2-1/4 X 4-1/2	73.70	CTC-2435799	P-UB-10	2-1/2 X 7-1/4	198.18
CTC-2418916	P-UB-10	2-1/4 X 3-1/2	191.43	CTC-2435800	P-UB-10	2-1/2 X 4-3/4	176.94
CTC-2418917	P-UB-10	2-1/4 X 4-1/2	175.22	CTC-2435801	P-UB-10	2-1/2 X 5-1/2	208.54
CTC-2418919	P-UB-10	2-1/4 X 4-1/2	180.36	CTC-2435802	P-UB-10	2-1/2 X 5-1/4	216.99
CTC-2418920	P-U-10	2-1/4 X 4-3/4	161.70	CTC-2435803	P-UB-10	2-1/2 X 6-1/2	220.31
CTC-2418921	P-UB-10	2-1/4 X 4	74.05	CTC-2435804	P-UB-10	2-1/2 X 4-3/4	173.71
CTC-2418924	P-UB-10	2-3/4 X 4-1/2	76.00	CTC-2435805	P-UB-10	2-1/2 X 4-1/2	113.45
CTC-2418925	P-UB-10	2-3/8 X 4	56.47	CTC-2435806	P-UB-10	2-1/2 X 4-1/2	179.41
CTC-2422538	P-UB-10	2-1/2 X 4-1/4	57.06	CTC-2435808	P-UB-10	2-3/4 X 4-1/2	145.66
CTC-2422539	P-UB-10	2-1/2 X 5-1/2	79.98	CTC-2435809	P-U-10	2-3/4 X 5	72.64
CTC-2422540	P-UB-10	2-1/2 X 6	93.54	CTC-2435810	P-UB-10	2-3/4 X 5-1/4	124.29
CTC-2422541	P-UB-10	2-1/2 X 6-1/2	272.12	CTC-2435811	P-UB-10	2-3/4 X 5	61.74

# REPLACEMENT KITS FOR CATERPILLAR® EQUIPMENT

**NOTE:** CATERPILLAR® kit numbers are used as a reference only. We do not imply that these kits are original REPLACEMENT KITS.

Kit Number	Code (Pg. xviii)	Rod X Bore Size	List Price	Kit Number	Code (Pg. xviii)	Rod X Bore Size	List Price
CTC-2435812	P-UB-10	2-3/4 X 6-1/2	\$133.69	CTC-2445647	P-UB-10	2-3/4 X 6	\$239.06
CTC-2435814	P-UB-10	2-3/4 X 7-1/4	240.40	CTC-2448777K	P-UB-10	3-3/4 X 7-3/4	252.44
CTC-2435815	P-UB-10	2-3/4 X 7	225.85	CTC-2450579	P-UB-10	3-1/4 X 5-1/2	349.43
CTC-2435816	P-UB-10	2-3/4 X 6-1/2	92.58	CTC-2450580	P-UB-10	3-1/4 X 8-1/4	271.17
CTC-2435818	P-UB-10	2-3/4 X 7	279.21	CTC-2450581	P-UB-10	3-1/4 X 7	244.19
CTC-2435820	P-UB-10	2-3/4 X 7-1/4	223.15	CTC-2450582	P-UB-10	3-1/4 X 7	277.19
CTC-2436225	P-UB-10	4-1/4 X 8-1/4	230.86	CTC-2450584	P-UB-10	3-1/4 X 8-1/4	168.40
CTC-2440953	P-UB-10	2-3/4 X 6	102.45	CTC-2450585	P-UB-10	3-1/4 X 7	108.13
CTC-2440954	P-UB-10	2-3/4 X 7-1/4	151.62	CTC-2450586	P-UB-10	3-1/4 X 7	250.86
CTC-2440955	P-UB-10	2-3/4 X 6	67.62	CTC-2450588	P-UB-10	3-1/4 X 9-1/4	269.57
CTC-2440957	P-UB-10	2-3/4 X 7-1/4	284.08	CTC-2450589	P-UB-10	3-1/4 X 9-1/4	230.01
CTC-2440958	P-UB-10	2-3/4 X 5	119.09	CTC-2450590	P-UB-10	3-1/4 X 9-1/4	350.72
CTC-2440959	P-UB-10	2-3/4 X 4-1/4	100.02	CTC-2450592	P-UB-10	3-1/4 X 5-1/2	145.91
CTC-2440960	P-UB-10	2-3/4 X 5-1/2	180.25	CTC-2450593	P-UB-10	3-1/4 X 8-1/4	289.59
CTC-2440961	P-UB-10	2-3/4 X 6	73.74	CTC-2450594	P-UB-10	3-1/4 X 7-3/4	180.79
CTC-2440962	P-UB-10	2-3/4 X 6-1/2	205.05	CTC-2450596	P-UB-10	3-1/4 X 7-1/4	178.74
CTC-2440964	P-UB-10	2-3/4 X 4-1/4	79.71	CTC-2450599	P-UB-10	3-1/4 X 8-1/4	136.25
CTC-2440965	P-UB-10	2-3/4 X 5-1/2	215.61	CTC-2450601	P-UB-10	3-1/4 X 5-1/2	349.43
CTC-2440966	P-UB-10	2-3/4 X 5-1/2	231.41	CTC-2450602	P-UB-10	3-1/4 X 9-1/4	353.87
CTC-2440969	P-UB-10	2-3/4 X 6	201.84	CTC-2450603	P-UB-10	3-1/4 X 9-1/4	370.69
CTC-2440971	P-UB-10	2-3/4 X 4	182.83	CTC-2450605	P-UB-10	3-1/4 X 8-1/4	221.33
CTC-2440973	P-UB-10	2-3/4 X 6	223.14	CTC-2450606	P-UB-10	3-1/4 X 6-1/2	256.43
CTC-2440975	P-UB-10	3 X 6-1/2	231.20	CTC-2450607	P-UB-10	3-1/4 X 9-1/4	271.62
CTC-2440976	P-UB-10	3 X 4	76.01	CTC-2450609	P-UB-10	3-1/4 X 9-1/4	281.51
CTC-2440978	P-UB-10	3 X 5-1/2	272.21	CTC-2450611	P-UB-10	3-1/4 X 6-1/2	248.94
CTC-2440979	P-UB-10	3 X 5-1/2	100.46	CTC-2450612	P-UB-10	3-1/4 X 5-1/2	237.04
CTC-2440980	P-UB-10	3 X 6-1/2	153.19	CTC-2450613	P-UB-10	3-1/4 X 7-1/4	226.93
CTC-2442044	P-UB-10	3 X 6-1/2	105.58	CTC-2450614	P-UB-10	3-1/4 X 7-1/4	221.33
CTC-2442046	P-UB-10	3 X 7-1/4	151.54	CTC-2450617	P-UB-10	3-1/4 X 6	181.68
CTC-2442047	P-UB-10	3 X 7-1/4	253.22	CTC-2456815	P-V-10	1-1/4 X 4	31.93
CTC-2442049	P-UB-10	3 X 6-1/2	105.11	CTC-2456821	P-UB-10	8 X 12	1156.44
CTC-2442050	P-UB-10	3 X 6-1/2	121.76	CTC-2456824	P-UB-10	3-1/2 X 5-1/2	163.49
CTC-2442053	P-UB-10	3 X 6	323.29	CTC-2456825	P-UB-10	3-1/2 X 5-1/2	279.17
CTC-2442054	P-UB-10	3 X 4-3/4	326.29	CTC-2456826	P-U-10	3-1/2 X 8-1/4	281.08
CTC-2442055	P-UB-10	3 X 6	120.71	CTC-2456827	P-UB-10	3-1/2 X 8-1/4	342.43
CTC-2442056	P-UB-10	3 X 7-1/4	125.26	CTC-2456828	P-UB-10	3-1/2 X 6	322.60
CTC-2442059	P-UB-10	3 X 7-1/4	233.12	CTC-2456829	P-UB-10	3-1/2 X 6	164.84
CTC-2442060	P-UB-10	3-1/4 X 6	138.13	CTC-2456831	P-UB-10	3-1/2 X 7-1/2	214.77
CTC-2442064	P-UB-10	3 X 6	70.42	CTC-2456832	P-UB-10	3-1/2 X 8-1/2	350.84
CTC-2442067	P-UB-10	3 X 7-1/4	133.88	CTC-2456834	P-UB-10	3-1/2 X 7-1/2	151.55
CTC-2442069	P-UB-10	3 X 8-1/4	322.57	CTC-2456835	P-UB-10	3-1/2 X 8-1/4	184.00
CTC-2442070	P-UB-10	3 X 4-3/4	177.92	CTC-2456836	P-UB-10	3-1/2 X 7-1/2	262.16
CTC-2442071	P-UB-10	3 X 4-3/4	236.98	CTC-2456837	P-UB-10	3-1/2 X 8-1/4	167.80
CTC-2442072	P-UB-10	3 X 5-1/4	332.94	CTC-2456839	P-UB-10	3-1/2 X 7-1/4	174.13
CTC-2442073	P-UB-10	3 X 5-1/4	103.74	CTC-2456840	P-UB-10	3-1/2 X 4-1/2	309.07
CTC-2442074	P-UB-10	3 X 5	86.67	CTC-2457484K	P-UB-10	3-1/4 X 170 mm	218.79
CTC-2442075	P-UB-10	3 X 4-3/4	345.66	CTC-2457487K	P-UB-10	3-1/2 X 7-1/2	258.38
CTC-2442076	P-UB-10	3 X 7-1/4	223.09	CTC-2457491K	P-UB-10	3-1/4 X 6-1/4	210.06
CTC-2442077	P-UB-10	3 X 5-1/2	219.63	CTC-2459835	P-UB-10	2-3/8, 3-3/4, 6	367.44
CTC-2442079	P-UB-10	3-1/4 X 5-1/2	129.43	CTC-2459838	P-UB-10	3-3/4 X 6-1/2	313.78
CTC-2442080	P-UB-10	3-1/4 X 5-1/2	125.11	CTC-2459840	P-UB-10	3-3/4 X 7-3/4	334.07

# REPLACEMENT KITS FOR CATERPILLAR® EQUIPMENT

**NOTE:** CATERPILLAR® kit numbers are used as a reference only. We do not imply that these kits are original REPLACEMENT KITS.

Kit Number	Code (Pg. xviii)	Rod X Bore Size	List Price	Kit Number	Code (Pg. xviii)	Rod X Bore Size	List Price
CTC-2459842	P-UB-10	100 mm X 140 mm	\$159.99	CTC-2469101K	P-UB-10	3 X 5	\$106.76
CTC-2460192K	P-UB-10	1-1/2 X 3	36.51	CTC-2469885K	P-UB-10	2-1/4 X 4-1/2	61.22
CTC-2460635	P-UB-10	3-1/2 X 10	506.23	CTC-2470257	P-UB-10	90 X 130 mm	395.97
CTC-2460636	P-UB-10	3-1/2 X 4-1/2	263.26	CTC-2478790	P-UB-10	85 X 120	109.57
CTC-2460637	P-UB-10	3-1/2 X 10-1/2	421.12	CTC-2478792	P-UB-10	100 X 140	185.30
CTC-2460638	P-UB-10	3-1/2 X 8-1/4	122.22	CTC-2478868	P-UB-10	85 X 120	160.00
CTC-2460639	P-UB-10	3-1/2 X 7-1/4	302.78	CTC-2478878	P-UB-10	100 X 140	196.88
CTC-2460641	P-UB-10	4 X 6-1/2	511.78	CTC-2478888	P-UB-10	85 X 120	137.02
CTC-2460643	P-UB-10	4 X 6-1/2	460.79	CTC-2478974	P-UB-10	100 X 140	196.88
CTC-2460644	P-UB-10	4 X 10	383.08	CTC-2478995	P-UB-10	80 mm X 110 mm	146.23
CTC-2460645	P-UB-10	4 X 10	439.77	CTC-2478996	P-UB-10	85 X 120	162.84
CTC-2460648	P-UB-10	4 X 9-1/4	315.06	CTC-2478998	P-UB-10	85 X 120	162.84
CTC-2460649	P-UB-10	4 X 10-1/2	475.59	CTC-2479000	P-UB-10	85 X 120	148.20
CTC-2460652	P-UB-10	4 X 9-1/4	234.83	CTC-2479001	P-UB-10	85 X 120	148.20
CTC-2460653	P-UB-10	4 X 7	331.48	CTC-2479004	P-UB-10	90 X 125 mm	135.00
CTC-2460655	P-UB-10	4 X 7	377.93	CTC-2479005	P-UB-10	85 X 125	150.49
CTC-2460658	P-UB-10	4 X 6	339.78	CTC-2481162	P-UB-10	100 X 140 mm	180.56
CTC-2460659	P-UB-10	4 X 8-1/2	261.79	CTC-2481163	P-UB-10	100 X 140 mm	409.29
CTC-2463426	P-UB-10	4 X 4-1/2	254.68	CTC-2481165	P-UB-10	100 X 140	161.74
CTC-2463427	P-UB-10	4 X 8-1/2	172.71	CTC-2481166	P-UB-10	100 mm X 140 mm	205.30
CTC-2463430	P-UB-10	4-1/4 X 6-1/2	401.53	CTC-2481167	P-UB-10	100 X 140 mm	376.45
CTC-2463431	P-UB-10	4-1/4 X 7-3/4	381.58	CTC-2481168	P-UB-10	105 mm X 150 mm	193.47
CTC-2463432	P-UB-1	4-1/4	267.16	CTC-2481169	P-UB-10	105 X 150 mm	399.63
CTC-2463434	P-UB-10	5 X 7-3/4	632.57	CTC-2481172	P-UB-10	110 X 160 mm	401.78
CTC-2463437	P-UB-10	5-1/2 X 10-1/2	731.57	CTC-2481175	P-UB-10	4-3/4 X 6-1/2	469.13
CTC-2463439	P-UB-10	5-3/4 X 7	239.94	CTC-2481176	P-UB-10	4-3/4 X 6	382.68
CTC-2463440	P-UB-10	5-3/4 X 8-1/4	621.47	CTC-2481178	P-UB-10	4-3/4 X 7-1/4	438.35
CTC-2463442	P-UB-10	6 X 8-1/4	693.48	CTC-2481181	P-UB-10	4-3/4 X 7-1/4	457.79
CTC-2463445	P-UB-10	6 X 7-1/2	643.39	CTC-2481182	P-UB-10	4-3/4 X 7	436.65
CTC-2463448	P-UB-10	7 X 10	689.99	CTC-2481183	P-UB-10	4-3/4 X 6-1/2	429.68
CTC-2465907	P-UB-10	7 X 11-1/2	899.28	CTC-2481185	P-UB-10	4-3/4 X 7	475.97
CTC-2465909	P-UB-10	1-1/2 X 2-3/4	72.66	CTC-2481186	P-UB-10	140 X 200 mm	664.56
CTC-2465910	P-UB-10	1-1/2 X 4	44.46	CTC-2481188	P-UB-10	6-1/2 X 10-1/2	559.46
CTC-2465911	P-UB-10	1-1/2 X 2-1/2	53.16	CTC-2481197	P-UB-10	5-1/4 X 7-3/4	482.88
CTC-2465912	P-UB-10	1-1/2 X 2-3/4	53.99	CTC-2488788K	P-UB-10	65 mm X 115 mm	102.12
CTC-2465913	P-UB-10	1-1/2 X 3	60.96	CTC-2502475	P-UB-10	105 X 150	136.08
CTC-2465914	P-UB-10	1-1/2 X 3-1/2	77.58	CTC-2502485	P-UB-10	100 X 140	164.77
CTC-2465915	P-UB-10	1-1/2 X 3-1/2	79.74	CTC-2502486	P-UB-10	90 mm X 130 mm	197.09
CTC-2465916	P-UB-10	1-1/2 X 2-1/4	53.92	CTC-2502487	P-UB-10	85 X 120 mm	141.27
CTC-2465917	P-UB-10	1-1/2 X 3-1/2	69.86	CTC-2505861K	P-UB-10	3 X 4-1/2	95.62
CTC-2465919	P-UB-10	1-1/2 X 3-1/4	136.09	CTC-2519341	P-UB-10	100 X 170	264.56
CTC-2465922	P-UB-10	1-1/2 X 3	45.49	CTC-2519845	P-U-10	40 mm X 70 mm	70.43
CTC-2465925	P-UB-10	1-7/8 X 3	116.03	CTC-2521191	P-UB-10	95 X 160	195.29
CTC-2465926	P-UB-10	1-7/8 X 3-1/4	63.66	CTC-2522423	P-UB-10	130 X 180 mm	491.99
CTC-2465927	P-UB-10	1-7/8 X 3	109.58	CTC-2522425	P-UB-10	130 X 190 mm	519.96
CTC-2465928	P-UB-10	2-1/8 X 4	190.44	CTC-2525507	I-U-14	50 mm X 100 mm	159.23
CTC-2465929	P-UB-10	2-1/8 X 4	43.23	CTC-2526101	P-UB-10	90 X 160 mm	360.12
CTC-2465931	P-UB-10	2-1/8 X 4	165.03	CTC-2526337K	P-UB-10	65 mm X 115 mm	103.89
CTC-2465937	P-UB-10	85 mm X 130 mm	128.20	CTC-2535204	P-UB-10	2-3/8 X 4-1/4	52.05
CTC-2465938	P-UB-10	85 mm X 120 mm	184.12	CTC-2549037K	P-UB-10	70 X 130 mm	372.34
CTC-2465940	P-UB-10	90 X 130 mm	316.86	CTC-2567093	P-UB-10	100 X 170 mm	418.49

CATERPILLAR®



# REPLACEMENT KITS FOR CATERPILLAR® EQUIPMENT

**NOTE:** CATERPILLAR® kit numbers are used as a reference only. We do not imply that these kits are original REPLACEMENT KITS.

Kit Number	Code (Pg. xviii)	Rod X Bore Size	List Price	Kit Number	Code (Pg. xviii)	Rod X Bore Size	List Price
CTC-2578422	P-UB-10	2-3/8 X 3-3/4	\$ 52.88	CTC-2624418K	P-UB-10	1-1/2 X 3	\$ 40.73
CTC-2580313	P-UB-10	85 X 130	145.61	CTC-2633745K	P-UB-10	1-1/2 X 3	40.73
CTC-2580500	P-UB-10	85 X 120	145.51	CTC-2634068K	P-UB-10	1-1/2 X 3-1/2	73.25
CTC-2580501	P-UB-10	85 mm X 120 mm	153.47	CTC-2635008K	P-UB-10	1-1/2 X 3-1/2	73.25
CTC-2583621	P-U-10	35 mm X 75 mm	43.31	CTC-2666140	I-U-10	35 mm X 70 mm	40.95
CTC-2590459K	P-UB-10	1-1/2 X 2-3/4	43.33	CTC-2666967K	P-U-10	50 X 80	99.73
CTC-2590625	P-UB-10	90 X 130	159.82	CTC-2666975K	P-U-10	55 X 90	76.95
CTC-2590626	P-UB-10	90 X 130	140.30	CTC-2666977K	P-U-10	55 X 90	76.95
CTC-2590627	P-UB-10	90 X 130	140.30	CTC-2667861	P-UB-10	80 mm X 110 mm	137.27
CTC-2590628	P-UB-10	90 X 130	159.82	CTC-2667874	P-UB-10	85 mm X 120 mm	123.44
CTC-2590630	P-UB-10	95 mm X 130 mm	167.76	CTC-2667891	P-UB-10	85 X 120	160.00
CTC-2590631	P-UB-10	100 X 140	154.13	CTC-2667892	P-UB-10	85 X 120	137.02
CTC-2590632	P-UB-10	100 X 140	151.26	CTC-2668011	P-UB-10	85 X 120	160.00
CTC-2590633	P-UB-10	100 X 140	154.13	CTC-2668012	P-UB-10	100 X 140	196.88
CTC-2590634	P-UB-10	100 X 140	151.26	CTC-2668013	P-UB-10	95 X 135 mm	171.01
CTC-2590635	P-UB-10	100 X 140	154.13	CTC-2668014	P-UB-10	90 X 130 mm	443.80
CTC-2590636	P-UB-10	105 X 150	344.01	CTC-2668015	P-UB-10	100 X 140	139.68
CTC-2590637	P-UB-10	105 X 150	344.01	CTC-2668016	P-UB-10	105 X 150	335.81
CTC-2590648	P-UB-10	100 X 140	146.21	CTC-2668045	P-UB-10	95 X 135	134.16
CTC-2590650	P-UB-10	105 X 150	335.81	CTC-2668057	P-UB-10	85 X 120	137.02
CTC-2590656	P-UB-10	95 X 135	132.85	CTC-2689049K	P-UB-10	2-3/8 X 4-3/4	103.89
CTC-2590665	P-UB-10	95 X 135 mm	171.01	CTC-2689051K	P-UB-10	3 X 5-1/4	114.56
CTC-2590678	P-UB-10	90 X 130	130.20	CTC-2689437K	P-UB-10	2-1/2 X 5-1/4	82.09
CTC-2590695	P-UB-10	85 X 120	162.84	CTC-2692728K	P-UB-10	45 mm X 90 mm	108.38
CTC-2590699	P-UB-10	100 X 140	154.13	CTC-2692729K	P-UB-10	65 mm X 120 mm	82.60
CTC-2590706	P-UB-10	85 X 120	148.20	CTC-2692730K	P-UB-10	60 mm X 110 mm	152.73
CTC-2590712	P-UB-10	90 X 130	161.49	CTC-2696483K	P-UB-10	85 mm X 140 mm	127.86
CTC-2590719	P-UB-10	90 X 130	141.98	CTC-2701537	O-RING KIT		90.55
CTC-2590725	P-UB-10	100 X 140	151.26	CTC-2701539	O-RING KIT		41.81
CTC-2590729	P-UB-10	105 X 150	344.01	CTC-2711529	I-U-10	40 mm X 3-1/2	24.94
CTC-2590743	P-UB-10	105 X 150	125.22	CTC-2737025K	P-U-10	55 X 100	109.90
CTC-2590751	P-UB-10	110 X 160	230.22	CTC-2742460	P-UB-10	110 X 160	264.49
CTC-2590768	P-UB-10	115 X 170	323.25	CTC-2742461	P-UB-10	130 X 190	435.75
CTC-2590774	P-UB-10	95 X 135 mm	166.04	CTC-2742462	P-UB-10	110 X 170	269.29
CTC-2590775	P-UB-10	100 X 140	196.88	CTC-2742511	P-UB-10	85 X 120	117.70
CTC-2590776	P-UB-10	90 X 130 mm	304.21	CTC-2742515	P-UB-10	100 X 140	169.37
CTC-2590779	P-UB-10	105 X 150	320.70	CTC-2742526	P-UB-10	90 mm X 130 mm	124.86
CTC-2594733K	P-UB-10	2-1/2 X 4	85.17	CTC-2748318	P-UB-10	70 X 130 mm	343.18
CTC-2594737K	P-UB-10	2-1/2 X 4	85.17	CTC-2758416K	P-UB-10	2-1/4 X 3-3/4	56.57
CTC-2601518	P-UB-10	2-3/4 X 5-1/2	123.02	CTC-2763879K	P-U-10	45 X 75 mm	72.93
CTC-2605316	P-UB-10	80 mm X 120 mm	115.42	CTC-2764172	I-U-10	50 mm X 70 mm	46.99
CTC-2605317	P-UB-10	80 X 110	213.64	CTC-2764667K	P-UB-10	1-1/2 X 3-1/2	73.25
CTC-2605318	P-UB-10	75 mm X 110 mm	275.24	CTC-2773395	P-UB-14	55 X 95	96.93
CTC-2605319	P-UB-10	75 X 140 mm	406.05	CTC-2774140	P-UB-14	50 X 85	81.74
CTC-2610582	P-UB-10	3-1/2 X 9-1/4	367.06	CTC-2774167	P-UB-14	45 X 75	139.80
CTC-2611073	P-UB-10	3-1/4 X 5-1/2	270.10	CTC-2779900K	P-U-10	45 X 75 mm	69.86
CTC-2617175	P-UB-10	2 X 75 mm	80.06	CTC-2781970	I-U-10	30 mm X 60 mm	48.73
CTC-2618001	P-UB-10	2-3/4 X 6	139.57	CTC-2788641	P-U-10	45 X 80	73.47
CTC-2618566	P-UB-10	2 X 4	71.99	CTC-2790639	P-U-10	50 X 85	86.44
CTC-2620941	I-U-10	30 mm X 50 mm	25.18	CTC-2797940	P-U-10	45 X 80	78.40
CTC-2624415K	P-UB-10	1-1/2 X 3	40.73	CTC-2812321	P-U-10	50 X 85 mm	75.89

# REPLACEMENT KITS FOR CATERPILLAR® EQUIPMENT

**NOTE:** CATERPILLAR® kit numbers are used as a reference only. We do not imply that these kits are original REPLACEMENT KITS.

Kit Number	Code (Pg. xviii)	Rod X Bore Size	List Price	Kit Number	Code (Pg. xviii)	Rod X Bore Size	List Price
CTC-2812322	P-U-10	45 X 75 mm	\$ 69.86	CTC-3133829	P-UB-10	3-1/4" X 170 mm	\$340.00
CTC-2812323	P-U-10	50 X 80 mm	75.63	CTC-3156338	I-U-10	1 X 2-1/2	17.82
CTC-2821535K	P-U-10	55 X 100	109.92	CTC-3169205K	P-UB-10	1-1/2 X 3	40.73
CTC-2821537K	P-U-10	55 X 90	75.93	CTC-3170942	I-UB-10	5-1/2 X 9-1/2	387.15
CTC-2833454	P-UB-10	1-1/2 X 2-3/4	135.27	CTC-3171090K	P-UB-10	70 X 140 mm	349.71
CTC-2835988	P-UB-10	90 X 125 mm	842.40	CTC-3189220	P-UB-10	3-1/2 X 6-1/4	391.40
CTC-2836179	P-UB-10	70 X 100 mm	194.23	CTC-3189225	P-UB-10	4 X 7	412.41
CTC-2839122	P-U-10	35 X 65	42.83	CTC-3192248	P-UB-10	3-1/2 X 6-1/4	334.46
CTC-2845360	P-UB-10	2-1/4 X 3-3/4	166.09	CTC-3193556	P-UB-10	3 X 4-1/2	242.30
CTC-2848014K	P-U-1	13-1/2	2403.37	CTC-3193558	P-UB-10	3 X 4-3/4	120.49
CTC-2848015K	P-U-1	13-1/2	2403.37	CTC-3198295	P-UB-10	115 mm X 170 mm	231.37
CTC-2848016K	P-U-1	12-1/2	1186.73	CTC-3206346	P-UB-10	65 mm X 100 mm	152.97
CTC-2848017K	P-U-1	12-1/2	1186.25	CTC-3217048K	P-UB-10	2 X 4	70.69
CTC-2857486	P-UB-10	2-1/8 X 4	81.44	CTC-3249485	P-UB-10	105 mm X 150 mm	188.00
CTC-2860113	P-UB-10	70 mm X 100 mm	113.35	CTC-3255723K	P-UB-10	2-1/2 X 5	76.42
CTC-2860814K	P-UB-10	2 X 4	69.07	CTC-3260502	P-UB-10	2 X 3-1/2	139.24
CTC-2863591	I-U-10	25 mm X 40 mm	20.64	CTC-3260504	P-UB-10	1-3/4 X 3	68.83
CTC-2871973K	P-UB-10	2-1/4 X 4	78.48	CTC-3265051	I-U-10	75 mm X 100 mm	66.61
CTC-2897878K	P-UB-10	90 X 130	160.35	CTC-3265237	I-U-10	1-3/4 X 63 mm	66.64
CTC-2929043K	P-UB-10	2 X 4-1/2	61.82	CTC-3265946	I-U-10	50 mm X 100 mm	69.64
CTC-2929044K	P-UB-10	2 X 4	69.02	CTC-3281867	I-U-14	50 mm X 100 mm	159.23
CTC-2935360K	P-U-10	45 X 75 mm	49.85	CTC-3284267K	P-UB-10	2-1/2 X 5-1/2	79.98
CTC-2937158K	P-U-10	55 X 90	76.95	CTC-3319328	P-UB-10	130 mm X 190 mm	330.30
CTC-2937596	P-UB-10	2 X 3	40.04	CTC-3338675	P-UB-10	110 mm X 170 mm	222.64
CTC-2940509K	P-UB-10	3 X 5	109.24	CTC-3338750	P-UB-10	110 mm X 160 mm	172.56
CTC-2940510K	P-UB-10	95 mm X 150 mm	204.91	CTC-3350007	P-UB-10	80 X 120 mm	145.42
CTC-2949583	P-UB-10	2-1/2 X 3-1/2	70.16	CTC-3367341	P-UB-1	12-1/2	2856.57
CTC-2950145	I-UB-10	5-1/2 X 7-1/2	274.53	CTC-3388416K	P-UB-10	70 X 140 mm	349.71
CTC-2950147	P-U-3	7 X 8-1/2	275.90	CTC-3408752K	P-UB-10	2-1/2 X 5	84.07
CTC-2950148	P-UB-3	7 X 8	655.52	CTC-3408871K	P-UB-10	2-1/2 X 4-3/4	96.98
CTC-2950148AV	P-SP-3	7 X 8	597.14	CTC-3460643	P-U-10,12	2 X 3-1/2	43.93
CTC-2959885	P-UB-1	9 X 10-1/2	263.81	CTC-3460644	P-U-10,12	3-1/4 X 5-1/2	97.87
CTC-2959886	P-U-3	7 X 8-1/2	274.89	CTC-3461093K	P-UB-10	70 X 140 mm	349.71
CTC-2959887	P-UB-10	3 X 5-1/4	117.14	CTC-3461094K	P-UB-10	70 X 140 mm	349.71
CTC-2959888	P-UB-10	3-1/2 X 6-1/4	206.33	CTC-3465609	P-U-10,12	1-3/4 X 3	39.06
CTC-2959890	P-UB-10	3 X 6	225.14	CTC-3473272K	P-UB-10	3-1/2 X 7-1/4	155.73
CTC-2959891	P-UB-10	2-1/4 X 4-1/2	63.44	CTC-3500967	P-UB-10	85 X 120 mm	227.56
CTC-2959892	P-UB-10	3-1/2 X 5-1/2	150.53	CTC-3507157	I-SP-3,10	7-3/4,11-1/2 X	684.69
CTC-2959895	P-UB-10	130 X 180	299.04	CTC-3652880	P-UB-10	3-3/4 X 7-3/4	185.91
CTC-2976848	P-U-3	7 X 8-1/2	284.64	CTC-3704117	I-U-15	70 mm X 125 mm	407.17
CTC-2976849	P-U-1	9 X 10-1/2	392.20	CTC-3712697	P-U-10	35 mm X 50 mm	41.21
CTC-2976852	P-UB-1	9 X 10-3/4	1677.60	CTC-3712718	P-U-10	30 mm X 65 mm	37.86
CTC-2S3477	P-V-10	3 X 9-1/4	190.20	CTC-3712737	P-U-10	45 mm X 65 mm	39.25
CTC-3044900K	P-UB-14	75 X 110 mm	128.00	CTC-3712751	P-U-10	35 mm X 75 mm	45.35
CTC-3050795	O-RING KIT		8.20	CTC-3712756	P-U-10	40 mm X 60 mm	41.89
CTC-3076273	P-UB-10	2 X 3	37.23	CTC-3712760	P-U-10	35 mm X 70 mm	42.71
CTC-3087830	P-UB-10	110 X 160 mm	405.89	CTC-3751733	P-UB-10	115 mm X 170 mm	252.09
CTC-3087849	P-UB-1	9 X 10-3/4	1677.60	CTC-3764331	P-UB-10	105 mm X 150 mm	157.38
CTC-3105478	P-UB-10	1-3/4 X 3-1/2	181.62	CTC-3764332	P-UB-10	105 mm X 150 mm	157.38
CTC-3110662	P-UB-10	2-1/4 X 4-1/2	68.90	CTC-3764333	P-UB-10	115 mm X 170 mm	231.37
CTC-3126388	I-SP-10	5,7-1/2X 6-1/2, 8-1/4	480.32	CTC-3764334	P-UB-10	105 mm X 150 mm	188.00

CATERPILLAR®



# REPLACEMENT KITS FOR CATERPILLAR® EQUIPMENT

**NOTE:** CATERPILLAR® kit numbers are used as a reference only. We do not imply that these kits are original REPLACEMENT KITS.

Kit Number	Code (Pg. xviii)	Rod X Bore Size	List Price	Kit Number	Code (Pg. xviii)	Rod X Bore Size	List Price
CTC-3764336	P-UB-10	110 mm X 160 mm	\$180.37	CTC-7X2487	P-UB-10	2 X 4	\$ 31.51
CTC-3E3291	P-UB-10	1-3/4 X 2-3/4	35.71	CTC-7X2654	PI-UB-10	2-1/2 X 4	119.01
CTC-3E3292	P-UB-10	4 X 6	223.01	CTC-7X2657	P-UB-10	2-1/2 X 6-1/2	133.10
CTC-3E3293	P-UB-10	3 X 5-1/4	177.73	CTC-7X2680	P-UB-10	2-3/4 X 6	137.01
CTC-3E3294	P-UB-10	2 X 5	56.11	CTC-7X2681	P-UB-10	2-3/4 X 7-1/4	113.59
CTC-3E3297	P-UB-10	1-7/8 X 3-1/4	98.56	CTC-7X2682	P-UB-10	2-3/4 X 5	156.12
CTC-3E3298	P-UB-10	2-1/8 X 4	42.75	CTC-7X2683	P-UB-14	2-3/4 X 4-1/2	182.71
CTC-3E3299	P-UB-10	2-1/2 X 3-1/2	134.08	CTC-7X2684	P-UB-10	2-3/4 X 5-1/2	153.57
CTC-3E3300	P-UB-10	2-1/2 X 4-1/4	107.47	CTC-7X2685	P-UB-14	2-3/4 X 4-1/2	164.23
CTC-3E3301	P-UB-10	4-3/4 X 7	204.99	CTC-7X2686	P-UB-14	2-3/4 X 6-1/2	120.72
CTC-3E3302	P-UB-10	2-1/2 X 5	66.34	CTC-7X2687	P-UB-10	2-3/4 X 7-1/4	266.41
CTC-3E3303	P-UB-10	4 X 6-1/2	270.89	CTC-7X2688	P-UB-14	2-3/4 X 6-1/4	147.96
CTC-3E3313	P-UB-10	3 X 5-1/4	70.04	CTC-7X2689	P-UB-10	2-3/4 X 6-1/2	161.01
CTC-3E3314	I-UB-10	2-3/4 X 3-3/4	171.80	CTC-7X2690	P-UB-10	2-3/4 X 5-1/2	99.55
CTC-3E8877	P-UB-10	2-3/8 X 4-1/2	177.68	CTC-7X2691	P-UB-14	2-3/4 X 7	146.58
CTC-3E8878	P-UB-10	2-3/4 X 5	182.11	CTC-7X2692	P-UB-10	2-1/2 X 6	164.27
CTC-3E8880	P-UB-10	5-3/4 X 8-1/4	723.29	CTC-7X2693	P-UB-10	3 X 6-1/2	180.48
CTC-3E8881	P-UB-10	4-3/4 X 7-1/4	288.97	CTC-7X2694	P-UB-10	3 X 6-1/2	158.86
CTC-3E8883	P-UB-10	3 X 4-3/4	155.39	CTC-7X2695	P-UB-10	3 X 8-1/4	355.45
CTC-3E8884	P-UB-10	2 X 4	101.05	CTC-7X2696	P-UB-10	3 X 6-1/2	87.35
CTC-3E8887	P-UB-10	5 X 7-3/4	449.10	CTC-7X2697	P-UB-10	3 X 6-1/4	158.18
CTC-3E8888	P-UB-10	3-3/4 X 6	316.59	CTC-7X2698	P-UB-10	3 X 6	186.32
CTC-3E8889	P-UB-10	3-1/2 X 6	199.13	CTC-7X2699	P-UB-14	3 X 7-1/4	215.29
CTC-3G0688K	I-SP-1	7 X 8-1/2	227.47	CTC-7X2700	P-V-10	2 X 4-1/2	70.97
CTC-3G9892K	P-UB-10	2 X 4	53.31	CTC-7X2701	P-UB-14	3 X 6-1/4	112.69
CTC-4C4782	NITRILE O-RING KIT		261.49	CTC-7X2702	P-UB-10	3 X 7-1/4	283.88
CTC-4C4784	D-RING KIT		154.76	CTC-7X2703	P-UB-14	3-1/4 X 8-1/4	235.71
CTC-4C4788	O-RING KIT		90.55	CTC-7X2704	P-UB-10	3-1/4 X 7	141.41
CTC-4C8253	SILICONE O-RING KIT		416.89	CTC-7X2705	P-UB-10	3-1/4 X 5-1/2	258.00
CTC-4T9977K	P-UB-10	3-1/4 X 8-1/4	155.76	CTC-7X2706	P-UB-10	3-1/4 X 7-3/4	266.70
CTC-4Z6110K	P-UB-10	3-1/2 X 8-1/4	175.35	CTC-7X2707	P-UB-10	3-1/4 X 9-1/4	346.13
CTC-4Z6364K	P-UB-10	3 X 6	125.13	CTC-7X2707A	P-UB-10	3-1/4 X 9-1/4	278.29
CTC-5P8433	D-RING KIT		154.76	CTC-7X2708	P-UB-10	3-1/4 X 9-1/4	203.80
CTC-5R4759	P-UB-10	1-3/4 X 3	78.84	CTC-7X2709	P-UB-14	3-1/4 X 5-1/2	161.53
CTC-5R4760	P-UB-10	1-1/2 X 3-1/2	48.64	CTC-7X2710	P-UB-10	3-1/4 X 7	203.20
CTC-5R4761	P-UB-10	2 X 3-1/4	78.80	CTC-7X2711	P-UB-10	3-1/4 X 6-1/2	209.68
CTC-5R4762	P-UB-10	2 X 3-1/4	54.46	CTC-7X2712	P-UB-10	3-1/4 X 5-1/2	92.64
CTC-5R4764	P-UB-10	1-1/2 X 2-1/2	30.70	CTC-7X2713	P-UB-14	3-1/4 X 6-1/2	133.64
CTC-5R4765	P-UB-10	1-1/2 X 2-1/2	30.70	CTC-7X2714	P-UB-14	3-1/4 X 5-1/2	161.53
CTC-6C6156	P-UB-10	100 X 170 mm	365.29	CTC-7X2715	P-UB-10	3-1/4 X 8-1/4	264.94
CTC-6E0274K	P-UB-10	2-3/8 X 4-1/2	81.63	CTC-7X2716	P-UB-10	3-1/4 X 9-1/4	159.60
CTC-6E0397K	P-UB-10	3 X 7-1/4	133.19	CTC-7X2717	P-UB-14	3-1/4 X 8-1/4	204.21
CTC-6E3113K	P-UB-10	1-3/4 X 4	45.90	CTC-7X2718	P-UB-10	3-1/4 X 7-1/4	198.65
CTC-6I6858	P-UB-10	70 X 100 mm	274.20	CTC-7X2719	P-UB-10	3-1/2 X 8-1/2	187.84
CTC-6Q2203	I,P-U-15	1-1/2	57.43	CTC-7X2720	P-UB-10	3-1/2 X 8-1/4	180.67
CTC-7S2720	I-V-10	3-1/4 X 9-1/4	253.56	CTC-7X2721	P-UB-10	3-1/2 X 8-1/4	291.15
CTC-7S2727	P-V-10	2-1/4 X 5	110.17	CTC-7X2722	P-UB-10	3-1/2 X 7-1/2	185.75
CTC-7U8058	I-U-10	2-3/4 X 4-1/2	276.37	CTC-7X2723	P-UB-10	3-1/2 X 10-1/2	251.16
CTC-7U8423	I-UB-10	2 X 4	154.89	CTC-7X2724	P-UB-14	3-1/2 X 8-1/4	203.18
CTC-7U9275	P-UB-4	4 X 4-1/2	315.57	CTC-7X2725	P-UB-10	3-1/2 X 8-1/4	389.08
CTC-7X2486	P-UB-10	3-1/4 X 8-1/4	121.41	CTC-7X2725X	P-UB-10	3-1/2 X 8-1/4	114.67

# REPLACEMENT KITS FOR CATERPILLAR® EQUIPMENT

**NOTE:** CATERPILLAR® kit numbers are used as a reference only. We do not imply that these kits are original REPLACEMENT KITS.

**CATERPILLAR®**

Kit Number	Code (Pg. xviii)	Rod X Bore Size	List Price	Kit Number	Code (Pg. xviii)	Rod X Bore Size	List Price
CTC-7X2726	P-UB-14	3-1/2 X 5-1/2	\$ 150.36	CTC-7X2794	P-UB-10	3-3/4 X 6	\$ 386.52
CTC-7X2727	P-UB-14	3-1/2 X 8-1/4	344.33	CTC-7X2795	P-UB-10	2-1/4 X 4	105.57
CTC-7X2728	P-UB-10	3-1/2 X 8-1/4	174.95	CTC-7X2797	P-V-10	2 X 5	70.91
CTC-7X2729	P-UB-10	2-1/4 X 5	162.34	CTC-7X2798	P-UB-10	2-1/4 X 3-3/4	75.90
CTC-7X2730	P-UB-14	3-1/2 X 7-1/2	160.02	CTC-7X2799	P-UB-10	4 X 9-1/4	357.79
CTC-7X2731	P-UB-10	3-3/4 X 6-1/2	259.04	CTC-7X2800	P-V-10	2 X 4	63.06
CTC-7X2734	P-UB-10	4 X 8-1/2	302.92	CTC-7X2801	P-UB-10	3-1/4 X 8-1/4	244.36
CTC-7X2736	P-UB-10	1-1/2 X 2-3/4	126.39	CTC-7X2802	P-UB-10	2-1/4 X 4	91.69
CTC-7X2737	P-UB-10	1-1/2 X 3	108.60	CTC-7X2803	P-UB-10	2-3/4 X 6	171.39
CTC-7X2738	P-UB-10	1-1/2 X 4	87.47	CTC-7X2804	P-UB-14	2-3/4 X 6-1/2	214.49
CTC-7X2739	P-UB-10	1-1/2 X 2-1/2	56.53	CTC-7X2805	P-UB-10	2 X 4-1/2	63.66
CTC-7X2740	P-UB-10	2-1/4 X 3-1/2	75.03	CTC-7X2806	P-UB-10	2 X 3-1/2	121.33
CTC-7X2741	P-UB-10	1-1/2 X 3-1/4	72.49	CTC-7X2807	P-UB-10	1-3/4 X 3-3/4	37.03
CTC-7X2742	P-UB-14	4 X 8-1/2	216.18	CTC-7X2808	P-UB-10	2-3/8 X 3-3/4	80.64
CTC-7X2743	P-UB-10	2-1/2 X 5	112.35	CTC-7X2809	P-UB-10	7 X 11-1/2	446.38
CTC-7X2744	P-UB-10	2-1/4 X 4	55.31	CTC-7X2810	P-UB-14	4 X 10	230.82
CTC-7X2745	P-UB-10	1-1/2 X 3	108.60	CTC-7X2811	P-UB-14	4 X 10	274.54
CTC-7X2746	P-UB-10	1-1/2 X 3-1/2	61.17	CTC-7X2812	P-UB-10	1-1/2 X 3-1/2	104.03
CTC-7X2747	P-UB-10	2-1/4 X 4-1/2	186.83	CTC-7X2813	P-UB-10	3 X 5-1/2	227.02
CTC-7X2748	P-UB-10	2-1/4 X 4-1/2	107.59	CTC-7X2814	P-UB-14	3-3/4 X 6	198.57
CTC-7X2749	P-UB-10	1-1/2 X 2-3/4	59.06	CTC-7X2815	P-UB-10	2-1/4 X 4-3/4	96.71
CTC-7X2750	P-UB-10	2-1/4 X 4-1/4	114.40	CTC-7X2816	P-UB-10	4 X 5	252.86
CTC-7X2751	P-UB-10	1-1/2 X 3	64.04	CTC-7X2817	P-UB-10	4 X 10	285.36
CTC-7X2752	P-UB-10	1-1/2 X 3-1/2	95.40	CTC-7X2818	P-UB-10	2-1/4 X 3-1/2	90.21
CTC-7X2753	P-UB-10	2 X 3	64.85	CTC-7X2819	P-UB-10	2 X 4-1/4	105.12
CTC-7X2755	P-UB-10	2 X 4	147.15	CTC-7X2820	P-UB-10	1-3/4 X 2-3/4	79.12
CTC-7X2755A	P-UB-10	2 X 4	94.55	CTC-7X2821	P-UB-10	2 X 3-1/4	140.11
CTC-7X2756	P-UB-10	3 X 5-1/4	126.44	CTC-7X2822	P-U-10	2 X 3-1/2	95.53
CTC-7X2757	P-UB-10	3-1/4 X 6	267.61	CTC-7X2823	P-UB-10	3-1/4 X 5-1/2	237.08
CTC-7X2760	P-UB-10	2 X 3	70.47	CTC-7X2824	P-U-10	2-3/4 X 5	118.91
CTC-7X2762	P-UB-10	1-3/4 X 3-1/2	100.06	CTC-7X2825	P-UB-10	1-3/4 X 3	53.69
CTC-7X2763	P-V-10	2 X 5	135.46	CTC-7X2826	P-UB-10	1-1/2 X 2-1/4	40.74
CTC-7X2764	P-UB-10	1-3/4 X 3-1/4	68.76	CTC-7X2827	P-UB-10	1-3/4 X 2-1/2	40.02
CTC-7X2765	P-UB-14	4 X 6-1/2	235.71	CTC-7X2828	P-UB-10	1-3/4 X 2-3/4	55.61
CTC-7X2766	P-UB-10	2 X 4-1/4	44.13	CTC-7X2836	P-UB-14	2-1/2 X 6	256.92
CTC-7X2767	P-UB-10	2 X 3-1/4	67.91	CTC-7X2882	P-UB-10	1-3/4 X 3-1/2	65.18
CTC-7X2768	P-UB-10	2 X 4-1/2	88.67	CTC-7X7718	P-UB-10	4-3/4 X 6-1/2	251.23
CTC-7X2769	P-UB-10	2 X 3-1/2	112.87	CTC-7X7719	P-UB-10	4-3/4 X 6-1/2	265.67
CTC-7X2770	P-V-10	2 X 4-1/2	97.94	CTC-7X7734	P-UB-10	4-3/4 X 7	433.49
CTC-7X2773	P-UB-10	2-1/2 X 4-3/4	178.40	CTC-7X7735	P-UB-10	3-1/2 X 6	252.02
CTC-7X2782	P-UB-10	2 X 4	42.64	CTC-7X7937	P-UB-10	2 X 4	160.47
CTC-7X2783	P-UB-10	2 X 3-1/2	102.97	CTC-7X7938	P-UB-10	2 X 3-3/4	104.60
CTC-7X2784	P-UB-10	1-3/4 X 3-1/2	56.35	CTC-7X7947	P-UB-10	2 X 4	62.67
CTC-7X2785	P-UB-10	2 X 4	81.75	CTC-7X7956	P-UB-10	1-3/4 X 3	30.42
CTC-7X2787	P-UB-10	2 X 3-1/4	103.33	CTC-7Y4698	P-UB-10	105 X 150 mm	336.22
CTC-7X2788	P-UB-10	2 X 5	118.64	CTC-7Y4970	P-UB-10	110 X 170 mm	376.59
CTC-7X2789	P-UB-10	2 X 4	102.01	CTC-7Y5145	P-UB-10	85 X 130 mm	267.26
CTC-7X2790	P-UB-10	1-3/4 X 4	92.96	CTC-7Y5147	P-UB-10	95 X 130 mm	298.89
CTC-7X2791	P-UB-10	1-3/4 X 3	88.60	CTC-8C3316	P-UB-10	1-1/2 X 3-1/2	53.10
CTC-7X2792	P-UB-10	2 X 3-1/2	87.78	CTC-8C3317	P-UB-10	1-1/2 X 2-3/4	49.56
CTC-7X2793	P-UB-10	4 X 10-1/2	294.84	CTC-8C3318	P-UB-10	1-3/4 X 2-3/4	30.17

# REPLACEMENT KITS FOR CATERPILLAR® EQUIPMENT

**NOTE:** CATERPILLAR® kit numbers are used as a reference only. We do not imply that these kits are original REPLACEMENT KITS.

Kit Number	Code (Pg. xviii)	Rod X Bore Size	List Price	Kit Number	Code (Pg. xviii)	Rod X Bore Size	List Price
CTC-8C3319	P-UB-10	1-3/4 X 4	\$ 48.85	CTC-8T1411	P-UB-10	3-1/4 X 9-1/4	\$169.05
CTC-8C3408	P-UB-10	2 X 3-1/2	59.51	CTC-8T1412	P-UB-10	2 X 4-1/4	44.13
CTC-8C4029	P-UB-10	1-1/2 X 3	35.10	CTC-8T1413	P-UB-10	2-1/4 X 4-1/4	66.36
CTC-8C4398	P-UB-10	5-3/4 x 7	377.42	CTC-8T1414	P-UB-10	2 X 3-1/4	49.67
CTC-8C4510	P-UB-1	2	31.80	CTC-8T1415	P-V-10	6 X 8-1/4	295.84
CTC-8C5768	P-UB-10	2-1/2 X 6	99.20	CTC-8T1416	P-UB-10	2-1/2 X 7-1/4	91.03
CTC-8C5788	I-SP-10, 3	7-1/4, 11 X 9-1/2, 12-1/4	1056.94	CTC-8T1417	P-UB-10	2-3/4 X 7-1/4	113.59
CTC-8C6707	P-UB-10	3 X 6-1/2	143.83	CTC-8T1418	P-V-10	2-1/2 X 6	122.55
CTC-8C6896	P-UB-10	2-1/2 X 4-3/4	91.03	CTC-8T1419	P-UB-10	2 X 4-1/2	56.90
CTC-8C6958	P-UB-10	4-1/2 X 6	258.90	CTC-8T1420	P-UB-10	2 X 3-1/2	54.90
CTC-8C9353	P-UB-10	2 X 4	59.15	CTC-8T1421	P-V-10	2 X 4-3/4	83.36
CTC-8C9438	P-UB-10	2 X 4-1/2	74.69	CTC-8T1422	P-V-10	2-1/2 X 6	117.07
CTC-8J8902K	I-SP-1	9 X 10-1/2	477.26	CTC-8T1423	P-UB-10	3-1/2 X 7-1/2	123.17
CTC-8T1370	P-UB-10	2 X 4	55.58	CTC-8T1428	P-UB-10	3 X 5-1/4	126.44
CTC-8T1371	P-UB-10	1-3/4 X 4	50.07	CTC-8T1429	P-UB-10	2-1/2 X 4-1/4	49.39
CTC-8T1372	P-UB-10	1-1/2 X 3-1/2	46.06	CTC-8T1430	P-UB-10	3-1/4 X 9-1/4	146.92
CTC-8T1373	P-UB-10	1-3/4 X 3	42.88	CTC-8T1432	P-UB-10	4 X 10-1/2	174.67
CTC-8T1374	P-UB-10	2-1/2 X 5-1/2	93.39	CTC-8T1435	P-UB-10	1-1/2 X 3	43.73
CTC-8T1375	P-UB-10	2-1/2 X 5	67.29	CTC-8T1438	P-UB-10	2-1/2 X 4-1/4	62.74
CTC-8T1376	P-UB-10	2-1/2 X 6-1/2	79.55	CTC-8T1439	P-UB-10	2-1/4 X 4	63.68
CTC-8T1378	P-UB-10	2-1/2 X 4	67.91	CTC-8T1448	P-UB-10	3-1/2 X 10-1/2	159.03
CTC-8T1379	P-UB-10	3-1/4 X 8-1/4	126.13	CTC-8T1451	P-UB-10	3 X 6-1/4	93.71
CTC-8T1380	P-UB-10	2 X 3-1/2	52.83	CTC-8T1456	P-UB-14	6-1/2 X 10-1/2	425.14
CTC-8T1381	P-UB-10	2-1/2 X 4-3/4	77.47	CTC-8T1457	P-UB-10	4 X 7	192.08
CTC-8T1382	P-UB-10	1-1/2 X 4	37.32	CTC-8T1461	P-UB-10	4-1/4 X 6-1/2	227.57
CTC-8T1383	P-UB-10	2-3/4 X 6-1/2	83.53	CTC-8T1462	P-UB-14	4-3/4 X 6-1/2	243.48
CTC-8T1384	P-UB-10	4 x 8-1/2	312.37	CTC-8T1464	P-UB-10	2-3/8 X 4-1/4	53.61
CTC-8T1385	P-UB-10	2-1/4 X 5	94.98	CTC-8T1466	P-UB-10	2-1/2 X 4	65.46
CTC-8T1386	P-UB-10	2 X 4	86.04	CTC-8T1467	P-UB-10	3-1/2 X 8-1/4	145.13
CTC-8T1388	P-UB-10	1-3/4 X 3-1/2	48.93	CTC-8T1468	P-UB-10	3-1/2 X 8-1/4	124.74
CTC-8T1389	P-UB-10	2-3/8 X 4	47.61	CTC-8T1470	P-UB-10	2-3/4 X 4-1/2	92.86
CTC-8T1390	P-V-10	2 X 5	80.88	CTC-8T1472	P-UB-10	2-1/2 X 6-1/2	81.47
CTC-8T1391	P-UB-10	3-1/4 X 6-1/4	92.64	CTC-8T1473	P-UB-10	2-1/4 X 3-3/4	42.85
CTC-8T1392	P-UB-10	1-3/4 X 3-1/4	55.82	CTC-8T1474	P-UB-10	4 X 9-1/4	398.26
CTC-8T1393	P-UB-10	3-1/2 X 8-1/2	145.26	CTC-8T1477	P-UB-14	3-1/2 X 8-1/4	202.30
CTC-8T1394	P-UB-10	3-1/4 X 7	91.59	CTC-8T1478	P-UB-10	3-1/4 X 7	196.06
CTC-8T1395	P-UB-10	2-1/4 X 4-1/2	64.23	CTC-8T1479	P-UB-10	5 X 7-3/4	381.67
CTC-8T1396	P-UB-10	2-1/4 X 4-1/2	56.11	CTC-8T1480	P-V-10	1-1/4 X 4	82.72
CTC-8T1397	P-UB-10	1-1/2 X 2-1/2	46.28	CTC-8T1481	P-V-10	2 X 4	67.79
CTC-8T1398	P-UB-14	3-1/4 X 5-1/2	207.34	CTC-8T1484	P-UB-10	2-1/4 X 4	62.69
CTC-8T1399	P-UB-10	3-1/4 X 7-3/4	122.82	CTC-8T1488	P-V-10	2-1/2 X 6	103.74
CTC-8T1400	P-UB-10	3 X 6-1/2	80.75	CTC-8T1489	P-UB-10	3 X 6	127.92
CTC-8T1401	P-V-10	3-1/2 X 8-1/4	156.77	CTC-8T1494	P-UB-10	2-3/4 X 5-1/2	80.69
CTC-8T1402	P-UB-10	1-1/2 X 2-3/4	49.56	CTC-8T1525	P-UB-10	2-3/4 X 5-1/2	97.25
CTC-8T1403	P-V-10	2-1/2 X 6	117.07	CTC-8T1526	P-UB-10	2-3/4 X 6	76.15
CTC-8T1404	P-UB-10	2-3/4 X 7-1/4	110.25	CTC-8T1527	P-UB-10	2-3/4 X 5	73.98
CTC-8T1405	P-UB-10	3 X 8-1/4	\$148.23	CTC-8T1528	P-UB-10	2-3/4 X 6-1/2	81.52
CTC-8T1406	P-V-10	2-1/2 X 5	71.50	CTC-8T1529	P-UB-10	2-3/4 X 7	114.19
CTC-8T1408	P-UB-10	3 X 6-1/2	80.75	CTC-8T1530	P-UB-10	2-3/4 X 6-1/4	124.83
CTC-8T1409	P-UB-10	4 X 6-1/2	170.14	CTC-8T1531	P-UB-10	2 X 4-1/2	53.81
CTC-8T1410	P-UB-10	3-1/2 X 8-1/4	147.19	CTC-8T1532	P-V-10	2 X 3-1/2	63.42

# REPLACEMENT KITS FOR CATERPILLAR® EQUIPMENT

**NOTE:** CATERPILLAR® kit numbers are used as a reference only. We do not imply that these kits are original REPLACEMENT KITS.

**CATERPILLAR®**

Kit Number	Code (Pg. xviii)	Rod X Bore Size	List Price	Kit Number	Code (Pg. xviii)	Rod X Bore Size	List Price
CTC-8T1534	P-UB-10	2-1/2 X 4-1/2	\$ 64.67	CTC-8T4940	P-V-10	2-3/4 X 5	\$ 85.98
CTC-8T1541	P-UB-10	1-3/4 X 3-3/4	45.60	CTC-8T9042	I-SP-10	5,7-1/2 X 8-1/4	455.14
CTC-8T1542	P-UB-10	2-3/8 X 3-3/4	60.52	CTC-9S3135	SPLIT FLANGE O-RING KIT		55.59
CTC-8T1543	I-UB-10	5-1/2 X 9-1/2	460.28	CTC-9T0418	I-O-3	1 X 2	82.99
CTC-8T1544	P-UB-10	7 X 11-1/2	269.00	CTC-9T1834K	P-UB-10	2-1/8 X 3-1/4	219.93
CTC-8T1545	P-UB-14	4-3/4 X 7-1/4	288.97	CTC-9T2716K	P-UB-10	2-1/2 X 5	80.81
CTC-8T1546	P-UB-10	4 X 10	226.61	CTC-9T2869K	P-UB-10	3-1/2 X 6-1/4	203.66
CTC-8T1548	P-UB-10	1-1/2 X 3-1/2	47.96	CTC-9T3972K	I-SP-1	9 X 10-1/2	477.26
CTC-8T1549	P-UB-14	3 X 5-1/2	179.70	CTC-9T7125	P-SP-1	1" Rod Kit	16.04
CTC-8T1551	P-UB-14	3 X 7-1/4	180.44	CTC-9T8912K	I-U-1	2-3/4 X 5-1/2	148.64
CTC-8T1553	P-V-10	2-3/4 X 6	112.98	CTC-9X2020	I-UB-10	2-3/4 X 3-3/4	108.84
CTC-8T1554	P-V-14	2-3/4 X 6-1/2	137.77	CTC-9X2047	P-UB-10	2-1/2 X 5-1/2	108.20
CTC-8T1555	P-UB-14	3-1/4 X 6-1/2	177.46	CTC-9X2050	P-UB-10	2-1/2 X 5-1/2	100.69
CTC-8T1558	P-UB-10	5-3/4 X 8-1/4	665.65	CTC-9X2063	P-UB-10	4-3/4 X 7	210.23
CTC-8T1559	P-UB-10	3-1/2 X 8-1/4	112.32	CTC-9X2150	P-UB-10	1-1/2 X 2-3/4	57.16
CTC-8T1563	P-UB-10	3-1/4 X 5-1/2	98.91	CTC-9X2151	P-UB-10	2-1/2 X 4-3/4	83.05
CTC-8T1565	P-UB-14	4-3/4 X 7	245.44	CTC-9X2153	P-UB-10	1-1/2 X 2-3/4	53.08
CTC-8T1566	P-UB-14	3-1/4 X 6-1/2	177.53	CTC-9X2400	P-UB-10	2-1/8 X 4	119.16
CTC-8T1567	P-UB-14	4-3/4 X 7	238.41	CTC-9X2473	P-UB-10	2-3/4 X 6-1/2	134.57
CTC-8T1772	P-UB-10	2-1/2 X 4-1/2	81.36	CTC-9X2515	P-UB-10	2-1/4 X 4	55.31
CTC-8T1906	P-UB-10	3 X 6	92.14	CTC-9X2638	P-UB-10	1-3/4 X 2-3/4	35.71
CTC-8T1908	P-UB-14	4-3/4 X 6	217.82	CTC-9X2641	P-UB-10	2-1/4 X 4	55.31
CTC-8T1909	P-UB-10	5 X 6	337.75	CTC-9X2644	P-UB-10	3-1/2 X 7-3/4	231.80
CTC-8T2066	P-UB-10	2-1/2 X 6	105.74	CTC-9X2645	P-UB-10	3-1/2 X 7-3/4	113.57
CTC-8T2166	P-UB-10	3-1/4 X 8-1/4	132.48	CTC-9X6254	P-UB-10	4-1/4 X 6-1/2	242.01
CTC-8T2216	P-UB-10	2-1/4 X 4-3/4	78.66	CTC-9X6255	P-UB-10	4-1/4 X 6-1/2	244.72
CTC-8T2289	P-UB-10	4 X 5	109.78	CTC-9X6261	P-UB-10	4 X 6	283.98
CTC-8T2332	P-UB-10	3 X 6-1/4	103.65	CTC-9X6263	P-UB-10	4 X 6	233.98
CTC-8T2583	P-UB-14	3-1/2 X 8-1/2	191.45	CTC-9X6379	P-UB-10	4-1/4 X 6-1/2	317.44
CTC-8T3015	P-UB-10	2-1/2 X 3-3/4	58.87	CTC-9X6392	P-UB-10	2-1/4 X 5	160.01
CTC-8T3565	P-UB-10	4 X 10	387.93	CTC-9X6393	P-UB-10	3-3/4 X 6	273.29
CTC-8T3574	P-UB-10	2-1/4 X 3-1/2	50.39	CTC-C75300011	P-UB-13	70 X 110 mm	245.05
CTC-8T3575	P-UB-10	2 X 4-1/4	45.27	CTC-C75300021	P-UB-13	80 X 120 mm	234.35
CTC-8T3576	P-UB-10	2-1/2 X 5-1/2	90.37	CTC-C75300031	P-UB-13	65 X 110 mm	258.69
CTC-8T3577	P-UB-10	2-1/2 X 5-1/2	69.21	CTC-C95300623	P-UB-10	80 X 120 mm	277.06
CTC-8T3589	P-UB-10	1-7/8 X 3-1/4	80.81	CTC-C95300731	P-UB-10	65 X 100 mm	190.18
CTC-8T3590	P-UB-10	2 X 3-1/4	75.32	CTC-C95301729	P-UB-10	75 X 110 mm	194.70
CTC-8T3591	P-UB-10	2-1/8 X 3-1/2	104.90	CTC-E25300061	P-UB-14	90 X 140 mm	424.16
CTC-8T3592	P-UB-10	2 X 3-1/2	63.80	CTC-E35300040	P-UB-10	85 X 125 mm	322.75
CTC-8T3593	P-UB-10	2-1/8 X 4	70.99	CTC-E75300010	P-UB-10	100 X 140 mm	385.24
CTC-8T3648	P-UB-10	3-1/4 X 9-1/4	146.92	CTC-E85300011	P-UB-10	85 X 120 mm	388.95
CTC-8T3649	P-UB-10	3-1/2 X 7-1/2	126.14	CTC-E85300021	P-UB-10	95 X 130 mm	429.12
CTC-8T3739	P-UB-10	3-1/4 X 8-1/4	137.59	CTC-E85300031	P-UB-10	75 X 115 mm	360.69
CTC-8T3740	P-UB-10	3 X 7-1/4	119.16	CTC-F15300011	P-UB-14	100 X 150 mm	469.76
CTC-8T3741	P-UB-10	2-3/4 X 6-1/2	90.90	CTC-F15300021	P-UB-14	110 X 160 mm	389.76
CTC-8T3852	P-UB-10	1-7/8 X 3	192.90				
CTC-8T4770	P-UB-10	3-1/4 X 7-1/4	95.73				
CTC-8T4772	I-SP-10	4, 6-1/2 X 5-3/4	314.53				
CTC-8T4891	P-UB-10	2-1/2 X 4-3/4	77.23				
CTC-8T4892	P-UB-10	1-1/2 X 3-1/2	51.48				
CTC-8T4939	I-SP-10, 3	7-1/4, 10-1/2 X 9-1/4, 11-1/2	773.20				

# REPLACEMENT PARTS FOR CATERPILLAR® EQUIPMENT

**NOTE:** CATERPILLAR® kit numbers are used as a reference only. We do not imply that these kits are original REPLACEMENT KITS.

## PUMP KITS

Kit Number	Code (Pg. xviii)	List Price
CTC-3G1688	PUMP KITS	\$196.06
CTC-3G1689	PUMP KITS	184.07
CTC-3G1707	PUMP KITS	113.24
CTC-3G1708	PUMP KITS	161.32
CTC-4J9281	PUMP KITS	19.43
CTC-4J9285	PUMP KITS	29.16
CTC-8J8652	PUMP KITS	190.32
CTC-9J5108	PUMP KITS	40.14
CTC-9J5109	PUMP KITS	32.06
CTC-9J5110	PUMP KITS	35.09
CTC-9J5111	PUMP KITS	41.94
CTC-9J5112	PUMP KITS	38.43
CTC-9J5114	PUMP KITS	26.88
CTC-9J5115	PUMP KITS	36.32
CTC-9J5116	PUMP KITS	27.51

## ROD BUSHINGS

Part Number	Rod Dia.	List Price
CTC-0964402	85 mm	\$ 33.54
CTC-0964430	95 mm	36.43
CTC-0965625	100 mm	49.93
CTC-0995572	105 mm	42.95
CTC-1052575	90 mm	32.35
CTC-1140750	75 mm	29.93
CTC-1140751	60 mm	23.38
CTC-1140753	70 mm	28.52
CTC-1140754	65 mm	24.80
CTC-1140755	80 mm	32.83
CTC-1140756	85 mm	35.81
CTC-1140757	100 mm	50.34
CTC-1140758	90 mm	41.30
CTC-1140760	105 mm	54.85
CTC-1140761	110 mm	87.22
CTC-1140762	110 mm	81.65
CTC-1140763	130 mm	83.31
CTC-1148836	75 mm	32.87
CTC-1289260	95 mm	42.86
CTC-1460742	65 mm	12.59
CTC-1890593	1-1/4	11.56
CTC-1934637	3-1/2	91.73
CTC-1U4626	11	829.93
CTC-6C6093	95 mm	46.13
CTC-8T7692	7	309.57

## SELF-ALIGNING BALL BUSHINGS

Part Number	Rod Dia.	List Price
CTC-058639	1	\$ 19.40
CTC-9M3914	3/4	22.28
CTC-2D8652	1-1/4	28.00
CTC-4D0298	1-1/2	36.64
CTC-4D4431	1-3/4	50.29
CTC-9M1328	2	68.24
CTC-6V5002	2	81.89
CTC-7J1309 *	2-1/2	126.44
CTC-5P7802	2-3/4	148.46
CTC-7J3216	2-3/4	148.46
CTC-5J6424	3	222.69
CTC-5P7487	3-1/2	395.10

\* Sealed

## WIPERS

Part Number	Rod Dia.	List Price
CTC-5M6708	0.6	\$ 3.20
CTC-6J1879	3/4	2.65
CTC-2287467	5/8	6.85
CTC-5J2274	5/8	2.65
CTC-6J2274	5/8	2.65
CTC-0352379	7/8	4.61
CTC-1K9060	7/8	2.95
CTC-3E4124	1	4.71
CTC-6J1890	1	2.65
CTC-3E4138	1-1/8	2.65
CTC-1890218	1-1/4	12.34
CTC-3E4125	1-1/4	5.23
CTC-3E4139	1-1/4	2.89
CTC-3E4160	1-1/4	12.34
CTC-4J8982	1-1/4	14.28
CTC-3E4140	1-3/8	3.08
CTC-3E4159	1-3/8	12.48
CTC-1672450	1-1/2	26.61
CTC-2268202	1-1/2	26.61
CTC-3E4161	1-1/2	12.61
CTC-4J8979	1-1/2	13.15
CTC-5J6795	1-1/2	3.38
CTC-8C9131	1-1/2	26.61
CTC-3E4103	1-1/2	1.86
CTC-3E4126	1-1/2	6.01
CTC-3E4141	1-1/2	3.38
CTC-4T0486	1-5/8	13.33
CTC-3E4104	1-5/8	1.95

## WIPERS

Part Number	Rod Dia.	List Price
CTC-1506739	1-3/4	\$ 27.10
CTC-2313539	1-3/4	27.10
CTC-3E4105	1-3/4	1.95
CTC-3E4162	1-3/4	13.62
CTC-4J8980	1-3/4	13.86
CTC-7J6932	1-3/4	13.62
CTC-7K9202	1-3/4	13.62
CTC-8C9132	1-3/4	27.10
CTC-1672452	1-3/4	27.10
CTC-3E4127	1-3/4	6.39
CTC-3E4142	1-3/4	3.79
CTC-3E4150	1-3/4	4.47
CTC-1672455	1-7/8	27.56
CTC-2271143	1-7/8	27.56
CTC-3G4721	1-7/8	3.92
CTC-3P1347	1-7/8	13.95
CTC-4T6777	1-7/8	14.86
CTC-1672457	2	28.41
CTC-2299382	2	28.41
CTC-2332606	2	28.41
CTC-3081845	2	28.41
CTC-1K6981	2	17.85
CTC-3E4106	2	1.99
CTC-3E4128	2	7.29
CTC-3E4143	2	3.97
CTC-3E4151	2	5.09
CTC-3E4164	2	14.14
CTC-4T0415	2	3.97
CTC-5U3693	2	3.97
CTC-7K9203	2	15.70
CTC-8C9133	2	28.41
CTC-1506745	2-1/8	29.01
CTC-1672458	2-1/8	29.01
CTC-2271145	2-1/8	29.01
CTC-2332607	2-1/8	29.01
CTC-4T6125	2-1/8	10.33
CTC-3P1345	2-3/16	18.54
CTC-1672459	2-1/4	29.60
CTC-2313538	2-1/4	29.60
CTC-3E4107	2-1/4	2.12
CTC-4J3515	2-1/4	15.82
CTC-6J0217	2-1/4	4.19
CTC-7K9204	2-1/4	15.13
CTC-8C9134	2-1/4	29.60
CTC-3E4129	2-1/4	7.67
CTC-3E4144	2-1/4	4.19



# REPLACEMENT PARTS FOR CATERPILLAR® EQUIPMENT

**NOTE:** CATERPILLAR® kit numbers are used as a reference only. We do not imply that these kits are original REPLACEMENT KITS.

## WIPERS

Part Number	Rod Dia.	List Price
CTC-3E4152	2-1/4	\$ 5.36
CTC-3E4165	2-1/4	15.13
CTC-1672461	2-3/8	30.73
CTC-2313540	2-3/8	30.73
CTC-3P1461	2-3/8	12.97
CTC-5J8016	2-3/8	4.41
CTC-6J3892	2-3/8	13.07
CTC-8T1308	2-3/8	12.97
CTC-9J1319	2-3/8	13.07
CTC-1672463	2-1/2	31.88
CTC-2253281	2-1/2	31.88
CTC-2271148	2-1/2	21.85
CTC-7J8273	2-1/2	17.41
CTC-1K6982	2-1/2	17.41
CTC-3E4130	2-1/2	8.08
CTC-3E4153	2-1/2	5.64
CTC-5J8156	2-1/2	4.70
CTC-7K9205	2-1/2	17.12
CTC-8C3840	2-1/2	31.88
CTC-3E4108	2-1/2	2.39
CTC-3E4145	2-1/2	4.19
CTC-3E4166	2-1/2	17.12
CTC-2271146	2-5/8	21.48
CTC-3E4131	2-5/8	8.60
CTC-3G4719	2-5/8	4.70
CTC-7K9207	2-5/8	17.41
CTC-9X3569	2-5/8	22.61
CTC-1672467	2-3/4	33.77
CTC-2253283	2-3/4	33.77
CTC-1J3540	2-3/4	21.12
CTC-3E4109	2-3/4	2.52
CTC-3E4132	2-3/4	9.24
CTC-3E4168	2-3/4	19.39
CTC-3E4169	2-3/4	4.83
CTC-5J7036	2-3/4	4.83
CTC-7K9208	2-3/4	19.39
CTC-7J8274	2-3/4	21.12
CTC-7U4137	2-3/4	4.83
CTC-8C3842	2-3/4	33.77
CTC-9D6588	2-3/4	19.39
CTC-1672469	3	34.89
CTC-2253284	3	34.89
CTC-2J1411	3	23.14
CTC-3E4110	3	2.94
CTC-3E4133	3	10.38
CTC-3E4146	3	5.05

## WIPERS

Part Number	Rod Dia.	List Price
CTC-3E4154	3	\$ 7.22
CTC-3E4170	3	19.93
CTC-5J7030	3	5.02
CTC-5P4061	3	16.91
CTC-7K9209	3	19.93
CTC-8C5218	3	34.89
CTC-8J0249	3	23.14
CTC-9D6589	3	19.93
CTC-3G5050	3-1/8	17.76
CTC-5P4196	3-1/8	17.76
CTC-5P4976	3-1/8	17.76
CTC-2253285	3-1/4	35.88
CTC-3E4173	3-1/4	19.29
CTC-5J7034	3-1/4	5.58
CTC-6J4169	3-1/4	23.63
CTC-7K9211	3-1/4	19.39
CTC-8T8389	3-1/4	35.88
CTC-1433672	3-1/2	36.77
CTC-1672474	3-1/2	36.77
CTC-2253286	3-1/2	36.77
CTC-3E4147	3-1/2	5.75
CTC-3E4176	3-1/2	26.60
CTC-4J8981	3-1/2	36.77
CTC-5J7032	3-1/2	5.75
CTC-7K9212	3-1/2	26.60
CTC-7K9213	3-1/2	23.18
CTC-8C5219	3-1/2	36.77
CTC-8C5219	3-1/2	36.77
CTC-9D6591	3-1/2	19.39
CTC-3E4112	3-1/2	3.55
CTC-3E4134	3-1/2	12.30
CTC-3E4155	3-1/2	8.57
CTC-5U3529	3-1/2	5.75
CTC-3G5052	3-3/8	15.41
CTC-5P1177	3-3/8	15.41
CTC-3E4111	3-3/8	3.50
CTC-2271149	3-3/4	37.42
CTC-3E4113	3-3/4	3.75
CTC-4T5540	3-3/4	6.67
CTC-5P5322	3-3/4	32.01
CTC-7K9214	3-3/4	32.01
CTC-8C9135	3-3/4	37.42
CTC-8J6069	3-3/4	23.59
CTC-9J1325	3-3/4	23.59
CTC-1389739	4	7.49
CTC-1672482	4	37.68

## WIPERS

Part Number	Rod Dia.	List Price
CTC-3E4114	4	\$ 3.95
CTC-3E4135	4	16.04
CTC-3E4148	4	7.49
CTC-3E4156	4	9.47
CTC-3E4177	4	37.46
CTC-5J2221	4	7.49
CTC-7J5673	4	30.27
CTC-8C5220	4	37.68
CTC-3E4115	4-1/4	4.16
CTC-4T1637	4-1/4	7.74
CTC-5P3193	4-1/4	30.91
CTC-7J8942	4-1/4	38.82
CTC-3G5053	4-3/8	45.98
CTC-5P1176	4-3/8	45.98
CTC-3E4116	4-1/2	4.28
CTC-3E4136	4-1/2	18.70
CTC-3G8505	4-1/2	8.39
CTC-3J4458	4-1/2	51.91
CTC-7K9218	4-1/2	31.09
CTC-3E4157	4-1/2	10.53
CTC-3E4117	4-3/4	4.44
CTC-7J9256	4-3/4	42.34
CTC-0903016	5	44.86
CTC-3E4118	5	5.25
CTC-3E4137	5	20.92
CTC-3E4149	5	11.71
CTC-3E4158	5	12.45
CTC-7K9220	5	41.33
CTC-8J4520	5	56.20
CTC-9J2547	5	11.71
CTC-9X3582	5	63.47
CTC-4T5663	5-1/4	14.46
CTC-3E4119	5-1/4	5.32
CTC-6J3073	5-1/2	51.07
CTC-9X3573	5-1/2	39.90
CTC-9J5469	5-3/4	36.84
CTC-3E4120	5-3/4	6.38
CTC-1U2708	6	17.22
CTC-3E4121	6	6.68
CTC-3J7622	6	76.44
CTC-3E4122	6-1/2	7.05
CTC-5P2322	6-1/2	75.10
CTC-5P2672	6-1/2	24.89
CTC-6J0542	6-1/2	64.42
CTC-7J2806	6-1/2	59.06
CTC-8J1877	6-1/2	59.06

CATERPILLAR®

# REPLACEMENT PARTS FOR CATERPILLAR® EQUIPMENT

**NOTE:** CATERPILLAR® kit numbers are used as a reference only. We do not imply that these kits are original REPLACEMENT KITS.

## WIPERS

Part Number	Rod Dia.	List Price
CTC-3E4123	6-3/4	\$ 7.18
CTC-3J4460	6-3/4	57.43
CTC-8C9146	6-3/4	75.10
CTC-2J4779	7	133.92
CTC-5J2682	7	59.39
CTC-8C9136	7	78.41
CTC-9X7333	7	133.92
CTC-9X7366	7	59.39
CTC-7J3320	7-1/2	72.01
CTC-8J9934	8-1/2	61.27
CTC-2892957	9	175.07
CTC-6J7694	9	27.96
CTC-9X7354	9	175.07
CTC-1U4625	11	38.96
CTC-9X7368	11	38.96
CTC-4T4130	12-1/2	90.29
CTC-9X7369	12-1/2	90.29
CTC-1402392	35 mm	19.93
CTC-1404934	35 mm	17.28
CTC-1449492	40 mm	20.32
CTC-1754734	40 mm	21.12
CTC-6R8716	40 mm	4.18
CTC-1410713	45 mm	20.81
CTC-1461086	45 mm	22.92
CTC-1980662	45 mm	4.59
CTC-2330617	45 mm	9.77
CTC-2508702	45 mm	22.92
CTC-0957101	50 mm	22.83
CTC-1463958	50 mm	23.22
CTC-2725681	50 mm	35.32
CTC-2774129	50 mm	23.22
CTC-0996995	55 mm	26.09
CTC-1163392	55 mm	26.09
CTC-1659280	55 mm	27.64
CTC-2725644	55 mm	10.69
CTC-2773381	55 mm	27.64
CTC-0931433	60 mm	7.86
CTC-1163391	60 mm	28.27
CTC-1183119	60 mm	3.69
CTC-1659281	60 mm	29.96
CTC-2330618	60 mm	18.80
CTC-1163390	65 mm	29.98
CTC-1659282	65 mm	31.76
CTC-1948332	65 mm	31.76
CTC-A04501417	65 mm	29.98
CTC-0931434	70 mm	9.94

## WIPERS

Part Number	Rod Dia.	List Price
CTC-1163389	70 mm	\$ 32.17
CTC-1659283	70 mm	34.09
CTC-1982952	70 mm	34.09
CTC-2782324	70 mm	158.34
CTC-8Q5891	70 mm	23.99
CTC-A04501418	70 mm	32.17
CTC-1163388	75 mm	34.59
CTC-1659284	75 mm	36.64
CTC-A04501419	75 mm	34.59
CTC-0931379	80 mm	15.74
CTC-1163387	80 mm	40.79
CTC-1659285	80 mm	43.22
CTC-A04501420	80 mm	40.79
CTC-0940707	85 mm	49.05
CTC-1140644	85 mm	46.30
CTC-1211611	85 mm	49.05
CTC-1540729	85 mm	49.05
CTC-1659286	85 mm	49.05
CTC-2330622	85 mm	28.95
CTC-7Y5115	85 mm	46.30
CTC-0931441	90 mm	50.05
CTC-1163386	90 mm	50.05
CTC-1261885	90 mm	53.03
CTC-1540749	90 mm	53.03
CTC-1659287	90 mm	53.03
CTC-1661495	90 mm	33.77
CTC-1672473	90 mm	53.03
CTC-7X4803	90 mm	33.77
CTC-1359054	95 mm	27.56
CTC-1505828	95 mm	27.56
CTC-1659288	95 mm	27.56
CTC-2330624	95 mm	32.33
CTC-2590655	95 mm	27.56
CTC-7Y4626	95 mm	33.88
CTC-0960059	100 mm	52.55
CTC-1076254	100 mm	52.55
CTC-1140646	100 mm	52.55
CTC-1336904	100 mm	55.68
CTC-1540736	100 mm	55.68
CTC-1659289	100 mm	55.68
CTC-1672480	100 mm	55.68
CTC-7Y4667	105 mm	20.19
CTC-1140647	105 mm	50.78
CTC-1336813	105 mm	53.80
CTC-1336909	105 mm	53.80
CTC-1540767	105 mm	53.80

## WIPERS

Part Number	Rod Dia.	List Price
CTC-1659290	105 mm	\$ 53.80
CTC-1672483	105 mm	53.80
CTC-1119957	110 mm	53.84
CTC-1336814	110 mm	57.03
CTC-1659291	110 mm	57.03
CTC-7Y4940	110 mm	53.84
CTC-A04903618	110 mm	53.84
CTC-1915648	115 mm	24.83
CTC-2095877	115 mm	24.83
CTC-1659292	125 mm	32.51
CTC-1704830	125 mm	40.70
CTC-1119958	130 mm	64.46
CTC-1362443	130 mm	64.46
CTC-1659293	130 mm	68.30
CTC-1076615	140 mm	66.05
CTC-1659294	140 mm	69.98
CTC-1076616	150 mm	69.26
CTC-1659296	150 mm	73.38

## U-SEALS

Part Number	Rod Dia.	List Price
CTC-7J0375	5/8	\$ 6.86
CTC-6J1878	3/4	7.11
CTC-0352380	7/8	7.38
CTC-1890217	1-1/4	8.27
CTC-4T0959	1-1/4	9.07
CTC-5J8125	1-1/4	9.07
CTC-2S5867	1-1/2	17.11
CTC-5J8150	1-1/2	10.43
CTC-9J4038	1-1/2	15.84
CTC-1672300	1-3/4	8.62
CTC-5J8175	1-3/4	11.93
CTC-8J5816	1-3/4	11.93
CTC-3081883	1-3/4	19.40
CTC-4T0488	1-5/8	11.51
CTC-1672302	1-7/8	8.29
CTC-2332609	1-7/8	8.29
CTC-4S9006	1-7/8	24.88
CTC-4T6898	1-7/8	25.19
CTC-6J1889	1	4.52
CTC-1672304	2	11.58
CTC-2892946	2	9.00
CTC-3G3259	2	20.88

CATERPILLAR®



# REPLACEMENT PARTS FOR CATERPILLAR® EQUIPMENT

**NOTE:** CATERPILLAR® part numbers are used as a reference only. We do not imply that these kits are original REPLACEMENT PARTS.

## U-SEALS

Part Number	Rod Dia.	List Price
CTC-3G3260	2	\$ 14.86
CTC-5J8200	2	14.86
CTC-5U3644	2	8.66
CTC-9J1318	2	20.88
CTC-1672305	2-1/8	21.72
CTC-3P1344	2-1/8	15.62
CTC-4T6126	2-1/8	21.72
CTC-1672307	2-1/4	15.81
CTC-5J8225	2-1/4	15.81
CTC-7J4820	2-1/4	23.50
CTC-0917173	2-3/8	16.96
CTC-3G2911	2-3/8	46.62
CTC-5J8238	2-3/8	15.05
CTC-9J1322	2-3/8	15.05
CTC-1672314	2-1/2	16.20
CTC-3G3752	2-1/2	42.84
CTC-3G3809	2-1/2	42.84
CTC-4S9007	2-1/2	33.08
CTC-5J0964	2-1/2	15.40
CTC-7J4824	2-1/2	42.84
CTC-9X7257	2-1/2	42.84
CTC-1672438	2-1/2	87.09
CTC-3G4718	2-5/8	15.73
CTC-1672317	2-3/4	15.11
CTC-5J8275	2-3/4	15.73
CTC-9J2944	2-3/4	28.19
CTC-1P4879	3	37.85
CTC-5J8300	3	16.23
CTC-3124245	3	15.62
CTC-1672320	3-1/4	17.11
CTC-5J8325	3-1/4	17.11
CTC-7J2145	3-1/4	32.63
CTC-3G5051	3-3/8	17.11
CTC-5P1140	3-3/8	12.43
CTC-1049658	3-1/2	17.88
CTC-1672324	3-1/2	20.60
CTC-1P4880	3-1/2	23.07
CTC-5J8350	3-1/2	17.88
CTC-7J2150	3-1/2	35.15
CTC-3119317	3-1/2	17.98
CTC-5J8375	3-3/4	20.99
CTC-2U9113	4	22.96
CTC-5J8400	4	27.48
CTC-6J1425	4-1/4	27.85
CTC-9J1336	4-1/4	27.85
CTC-0917170	4-3/8	55.80

## U-SEALS

Part Number	Rod Dia.	List Price
CTC-1672336	4-1/2	\$ 31.68
CTC-6J1450	4-1/2	31.68
CTC-9J1340	4-1/2	31.68
CTC-6J1475	4-3/4	36.67
CTC-9J1344	4-3/4	36.67
CTC-4T5664	4-7/8	33.80
CTC-2U5379	5	23.05
CTC-3G5056	5	26.84
CTC-5P1139	5	26.84
CTC-6K2430	5	51.31
CTC-8J4524	5	56.12
CTC-9J1684	5	26.84
CTC-4T5699	5-1/4	35.61
CTC-6J1550	5-1/2	43.38
CTC-9J1692	5-1/2	43.38
CTC-3G2286	5-3/4	66.98
CTC-9J5467	5-3/4	59.40
CTC-9J5470	5-3/4	59.40
CTC-6J1650	6-1/2	68.12
CTC-8J1880	6-1/2	68.12
CTC-8J4387	6-1/2	81.70
CTC-1672352	7	74.24
CTC-3G2649	7	62.60
CTC-6J1700	7	62.60
CTC-1672354	8	391.61
CTC-9X7388	12-1/2	168.52
CTC-1449481	30 mm	9.76
CTC-2032344	35 mm	11.54
CTC-1402377	35 mm	9.40
CTC-2126073	40 mm	13.64
CTC-6R8715	40 mm	11.01
CTC-1449493	40 mm	14.66
CTC-1921159	40 mm	22.67
CTC-1463916	45 mm	11.69
CTC-1672297	45 mm	7.41
CTC-1980660	45 mm	13.50
CTC-1438914	45 mm	11.52
CTC-1920623	45 mm	18.90
CTC-2774161	45 mm	43.41
CTC-1463957	50 mm	16.47
CTC-2332610	50 mm	11.79
CTC-2725679	50 mm	16.19
CTC-2774130	50 mm	36.46
CTC-2332611	55 mm	54.15
CTC-2725642	55 mm	20.21
CTC-0996996	55 mm	20.21

## U-SEALS

Part Number	Rod Dia.	List Price
CTC-1672306	55 mm	\$ 34.67
CTC-2773383	55 mm	41.30
CTC-0931475	60 mm	16.30
CTC-1672301	60 mm	17.09
CTC-0931476	65 mm	17.89
CTC-1709856	65 mm	25.30
CTC-1915683	65 mm	23.81
CTC-0931477	70 mm	18.62
CTC-1709857	70 mm	35.30
CTC-8Q5877	70 mm	16.12
CTC-A04600915	70 mm	18.62
CTC-0963468	75 mm	22.66
CTC-8Q6011	75 mm	25.51
CTC-A04600918	75 mm	22.66
CTC-1709858	75 mm	20.53
CTC-0931479	80 mm	18.82
CTC-0994156	80 mm	24.79
CTC-1709859	80 mm	30.81
CTC-A04600917	80 mm	24.79
CTC-0961567	85 mm	27.31
CTC-1540730	85 mm	27.31
CTC-1672322	85 mm	27.31
CTC-1709860	85 mm	21.57
CTC-2742497	85 mm	34.01
CTC-7Y5117	85 mm	27.01
CTC-0961587	90 mm	40.61
CTC-1052577	90 mm	28.34
CTC-1540750	90 mm	28.34
CTC-1672325	90 mm	20.44
CTC-2160003	90 mm	28.65
CTC-2742498	90 mm	27.58
CTC-1505826	95 mm	21.81
CTC-1672326	95 mm	22.17
CTC-2160004	95 mm	8.08
CTC-2590653	95 mm	29.98
CTC-7Y4629	95 mm	29.98
CTC-0962664	100 mm	22.92
CTC-1076256	100 mm	32.78
CTC-1211371	100 mm	25.32
CTC-1373659	100 mm	25.32
CTC-1540737	100 mm	25.32
CTC-1672329	100 mm	33.81
CTC-1672330	100 mm	25.32
CTC-2160005	100 mm	22.92
CTC-2742499	100 mm	23.91
CTC-8U6849	100 mm	25.32

CATERPILLAR®

# REPLACEMENT PARTS FOR CATERPILLAR® EQUIPMENT

**NOTE:** CATERPILLAR® part numbers are used as a reference only. We do not imply that these kits are original REPLACEMENT PARTS.

## U-SEALS

Part Number	Rod Dia.	List Price
CTC-1948354	105 mm	\$ 36.26
CTC-1948364	105 mm	36.26
CTC-2590733	105 mm	46.97
CTC-7Y4670	105 mm	37.53
CTC-1289270	110 mm	42.41
CTC-1672338	110 mm	46.24
CTC-2590734	110 mm	57.45
CTC-3338688	110 mm	72.13
CTC-7Y4942	110 mm	42.41
CTC-1915646	115 mm	70.68
CTC-2042848	115 mm	70.68
CTC-2095876	115 mm	71.07
CTC-2590735	115 mm	75.71
CTC-2160008	130 mm	26.79
CTC-2590736	130 mm	174.55
CTC-2160009	140 mm	34.69
CTC-2160011	150 mm	16.21

## NON-CATERPILLAR® U-SEALS

Part Number	Rod Dia.	List Price
CTC-3E4244	1	\$ 4.58
CTC-3E4245	1-1/8	6.11
CTC-3E4175	1-1/8	5.69
CTC-3E4284	1-1/8	6.35
CTC-3E4246	1-1/4	5.05
CTC-3E4180	1-1/4	5.42
CTC-3E4181	1-1/4	5.84
CTC-3E4193	1-1/4	6.37
CTC-3E4182	1-3/8	6.19
CTC-3E4194	1-3/8	6.58
CTC-3E4283	1-3/8	6.20
CTC-3E4247	1-1/2	5.26
CTC-3E4183	1-1/2	6.28
CTC-3E4195	1-1/2	7.24
CTC-3E4215	1-1/2	8.78
CTC-3E4184	1-5/8	6.69
CTC-3E4201	1-5/8	7.03
CTC-3E4248	1-5/8	5.35
CTC-3E4185	1-3/4	7.09
CTC-3E4216	1-3/4	9.75
CTC-3E4249	1-3/4	5.48
CTC-3E4287	1-3/4	7.91
CTC-3E4250	2	5.69

## NON-CATERPILLAR® U-SEALS

Part Number	Rod Dia.	List Price
CTC-3E4186	2	\$ 7.90
CTC-3E4196	2	8.66
CTC-3E4217	2	10.42
CTC-3E4227	2	14.74
CTC-3E4251	2-1/4	5.91
CTC-3E4187	2-1/4	8.83
CTC-3E4197	2-1/4	9.72
CTC-3E4218	2-1/4	12.35
CTC-3E4228	2-1/4	16.42
CTC-3E4188	2-3/8	9.58
CTC-3E4204	2-3/8	9.60
CTC-3E4252	2-1/2	5.98
CTC-3E4189	2-1/2	9.51
CTC-3E4198	2-1/2	10.70
CTC-3E4219	2-1/2	12.46
CTC-3E4229	2-1/2	17.29
CTC-3E4285	2-1/2	12.48
CTC-3E4253	2-3/4	6.04
CTC-3E4199	2-3/4	11.67
CTC-3E4220	2-3/4	13.54
CTC-3E4230	2-3/4	19.73
CTC-3E4254	3	6.21
CTC-3E4190	3	11.50
CTC-3E4200	3	12.62
CTC-3E4221	3	14.63
CTC-3E4231	3	20.54
CTC-3E4255	3-1/4	6.31
CTC-3E4222	3-3/8	16.26
CTC-3E4286	3-3/8	16.30
CTC-3E4256	3-1/2	6.49
CTC-3E4191	3-1/2	13.71
CTC-3E4202	3-1/2	14.56
CTC-3E4223	3-1/2	17.79
CTC-3E4232	3-1/2	23.35
CTC-3E4192	3-3/4	16.03
CTC-3E4203	3-3/4	15.40
CTC-3E4224	3-3/4	18.93
CTC-3E4225	4	19.21
CTC-3E4233	4	26.36
CTC-3E4205	4-1/4	20.07
CTC-3E4206	4-1/2	19.92
CTC-3E4234	4-1/2	28.96
CTC-3E4207	4-3/4	21.87
CTC-3E4208	5	23.05
CTC-3E4226	5	26.33
CTC-3E4235	5	31.73

## NON-CATERPILLAR® U-SEALS

Part Number	Rod Dia.	List Price
CTC-3E4209	5-1/4	\$ 26.22
CTC-3E4210	5-1/2	26.14
CTC-3E4236	5-1/2	34.36
CTC-3E4211	6	27.32
CTC-3E4237	6	36.75
CTC-3E4212	6-1/2	30.97
CTC-3E4238	6-1/2	38.96
CTC-3E4213	7	33.54
CTC-3E4239	7	41.78
CTC-3E4240	7-1/2	48.72
CTC-3E4214	8	40.58

## ROD VEE SETS

Part Number	Rod Dia.	List Price
CTC-1J0132	1-1/4	\$ 8.45
CTC-1K7110	1-1/4	8.45
CTC-3D1123	1-1/2	14.11
CTC-2K0248	1-3/4	19.08
CTC-1K7112	2	16.82
CTC-3F9609	2	37.12
CTC-2K4434	2-1/4	19.25
CTC-1K7114	2-1/2	25.60
CTC-4F8420	2-1/2	35.00
CTC-4J5830	2-1/2	22.39
CTC-5F3498	2-3/4	37.32
CTC-2J1408	3	29.55
CTC-2K1516	3	44.65
CTC-4J6897	3-1/4	35.26
CTC-1J2148	3-1/2	59.28
CTC-8M3912	3-1/2	18.95
CTC-2K0050	4	59.24
CTC-2K1335	4-1/2	50.60
CTC-3J7768	7-1/4	133.36

## RECTANGULAR ROD SEALS

Part Number	Rod Dia.	Desc.	List Price
CTC-8C9139	2-1/2	Seal	\$ 21.42
CTC-5J1731	7	Seal	18.13
CTC-5J5150	7	Back-up Ring	13.41

# REPLACEMENT PARTS FOR CATERPILLAR® EQUIPMENT

**NOTE:** CATERPILLAR® part numbers are used as a reference only. We do not imply that these kits are original REPLACEMENT PARTS.

## RECTANGULAR ROD SEALS

Part Number	Rod Dia.	Desc.	List Price
CTC-8T3539	7	Seal	\$ 13.41
CTC-8T3540	7	Back-up Ring	20.77
CTC-6J7693	9	Seal	26.32
CTC-8T3541	9	Seal	13.41
CTC-8T3542	9	Back-up Ring	24.60
CTC-9J4753	9	Back-up Ring	13.41

## CUSHION SEALS

Part Number	List Price
CTC-2835972	\$ 15.33
CTC-2897921	26.80
CTC-6I6784	27.20
CTC-6I6785	31.34
CTC-6I6786	26.70
CTC-6I6787	26.00
CTC-6I6790	28.25
CTC-6I6791	29.80
CTC-6I6921	29.71
CTC-7I1352	26.95
CTC-D35310900	29.23

## 1 PIECE BUFFER RINGS

Part Number	Rod Dia.	List Price
CTC-5P4673	7/8	\$ 4.01
CTC-9J3497	1-1/4	4.21
CTC-6J9733	1-1/2	5.29
CTC-6J9178	1-3/4	5.09
CTC-4T6778	1-7/8	12.68
CTC-9X3566	1-7/8	15.79
CTC-6J6917	2	6.18
CTC-4T6127	2-1/8	6.42
CTC-4T6127N	2-1/8	6.42
CTC-9X3568	2-1/8	19.61
CTC-5J3616	2-1/4	6.42
CTC-6J6916	2-3/8	6.84
CTC-5J3620	2-1/2	7.00
CTC-1U4020	2-5/8	8.13
CTC-9T9363	2-5/8	23.69
CTC-6J6553	2-3/4	7.43
CTC-6J6915	3	7.82
CTC-6J7167	3-1/4	8.39
CTC-6J6736	3-1/2	10.61
CTC-8J6070	3-3/4	11.35
CTC-8J4627	4	18.27
CTC-7J8943	4-1/4	9.67
CTC-3G5055	4-3/8	8.65
CTC-7J9257	4-3/4	14.88
CTC-8J4509	5	16.20
CTC-9J5468	5-3/4	20.67
CTC-6J8631	6-1/2	19.91
CTC-9J2495	7	20.66
CTC-A04600811	65 mm	11.21
CTC-A04600813	80 mm	14.07
CTC-7Y4630	95 mm	50.91

## CUSHION SEALS

Part Number	List Price
CTC-0855864	\$ 16.90
CTC-0861089	27.20
CTC-0875389	32.16
CTC-0998282	25.01
CTC-1038341	28.68
CTC-1052581	22.75
CTC-1057265	13.21
CTC-1076260	43.23
CTC-1076266	22.48
CTC-1261870	26.95
CTC-1261876	19.93
CTC-1261879	24.04
CTC-1261935	29.16
CTC-1913128	26.61
CTC-1915706	31.16
CTC-1931369	3.83
CTC-2003620	32.16
CTC-2144501	19.93
CTC-2316805	91.20
CTC-2316843	31.16
CTC-2426833	26.54
CTC-2445323	7.56
CTC-2478789	20.62
CTC-2478791	26.00
CTC-2478829	20.85
CTC-2667859	16.94
CTC-2725637	11.90
CTC-2789128	6.96

## DYR STYLE BUFFER RINGS

Part Number	Rod Dia.	List Price
CTC-1672185	60 mm	\$ 48.05
CTC-1672186	1-1/2	2.72
CTC-1672191	1-3/4	19.02
CTC-1672192	1-7/8	3.70
CTC-1672242	45 mm	37.95
CTC-1506744	2-1/8	28.55
CTC-1672197	2-1/8	28.55
CTC-1672198	2-1/8	4.26
CTC-1672200	2-1/4	4.64
CTC-1672202	2-3/8	5.20
CTC-1672201	2-1/2	5.27
CTC-1672204	2-1/2	33.90
CTC-1485674	2-3/4	24.11
CTC-1672208	3	7.07
CTC-1672209	3-1/4	7.43
CTC-1672214	3-3/4	9.28
CTC-1672218	4-1/4	206.77
CTC-1672221	4-3/4	117.36
CTC-1672725	5-1/2	73.02
CTC-1672239	8	110.65
CTC-2095960	80 mm	37.24
CTC-3081876	2	66.56

## 2 PIECE BUFFER RINGS

Part Number	Rod Dia.	List Price
CTC-8C9122	1-1/2	\$ 14.69
CTC-1672190	1-3/4	3.32

CATERPILLAR®

# REPLACEMENT PARTS FOR CATERPILLAR® EQUIPMENT

**NOTE:** CATERPILLAR® part numbers are used as a reference only. We do not imply that these kits are original REPLACEMENT PARTS.

## 2 PIECE BUFFER RINGS

Part Number	Rod Dia.	List Price
CTC-8C9123	1-3/4	\$ 15.66
CTC-1672195	2	3.87
CTC-8C9124	2	17.14
CTC-8C9125	2-1/4	22.08
CTC-8C9138	2-3/8	24.59
CTC-8C3839	2-1/2	20.44
CTC-1672207	2-3/4	6.88
CTC-8C3841	2-3/4	26.06
CTC-8C9126	3	24.32
CTC-8C9121	3-1/4	25.96
CTC-1672211	3-1/2	8.03
CTC-8C9127	3-1/2	31.38
CTC-8C9128	3-3/4	33.27
CTC-1672216	4	10.87
CTC-8C9129	4	35.09
CTC-6E0425	4-1/4	56.08
CTC-1672220	4-1/2	60.71
CTC-3G8507	4-1/2	60.71
CTC-8C9144	4-1/2	60.71
CTC-9X7261	4-3/4	73.00
CTC-9X3581	5	75.84
CTC-9X7267	5-1/4	60.24
CTC-9X3575	5-3/4	99.33
CTC-8C9130	7	87.60
CTC-2774162	45 mm	48.18
CTC-1410706	50 mm	17.84
CTC-2774131	50 mm	17.84
CTC-0996997	55 mm	17.94
CTC-2773384	55 mm	17.94
CTC-0931481	60 mm	25.48
CTC-1336784	60 mm	25.48
CTC-0931482	65 mm	30.30
CTC-1262149	65 mm	30.30
CTC-A04601014	65 mm	30.30
CTC-0931483	70 mm	33.07
CTC-1262150	70 mm	33.07
CTC-1672235	70 mm	45.07
CTC-1709841	70 mm	33.07
CTC-1709842	75 mm	35.16

## 2 PIECE BUFFER RINGS

Part Number	Rod Dia.	List Price
CTC-A04601015	70 mm	\$ 33.07
CTC-0963469	75 mm	35.16
CTC-1262151	75 mm	35.16
CTC-A04601016	75 mm	35.16
CTC-0931484	80 mm	37.24
CTC-1262152	80 mm	37.24
CTC-1709843	80 mm	37.24
CTC-A04601017	80 mm	37.24
CTC-7Y5118	85 mm	39.95
CTC-1231943	85 mm	39.95
CTC-1540732	85 mm	39.95
CTC-1709844	85 mm	39.95
CTC-2043622	85 mm	39.95
CTC-2742494	85 mm	39.95
CTC-0961585	90 mm	48.22
CTC-1540752	90 mm	48.22
CTC-1672212	90 mm	48.22
CTC-1709845	90 mm	48.22
CTC-2043624	90 mm	48.22
CTC-2742495	90 mm	48.22
CTC-1672213	95 mm	50.91
CTC-1709846	95 mm	50.91
CTC-2095957	95 mm	50.91
CTC-2590652	95 mm	50.91
CTC-0962663	100 mm	52.38
CTC-1231983	100 mm	52.38
CTC-1540739	100 mm	52.38
CTC-1672215	100 mm	52.38
CTC-1709847	100 mm	52.38
CTC-2043623	100 mm	52.38
CTC-2742496	100 mm	52.38
CTC-1231942	105 mm	54.28
CTC-1540770	105 mm	54.28
CTC-1672217	105 mm	54.28
CTC-2096009	105 mm	54.28
CTC-2667956	105 mm	54.28
CTC-1289266	110 mm	56.51
CTC-2667957	110 mm	56.51
CTC-7Y4943	110 mm	56.51

## 2 PIECE BUFFER RINGS

Part Number	Rod Dia.	List Price
CTC-A04601018	110 mm	\$ 56.51
CTC-1915645	115 mm	31.17
CTC-2590773	115 mm	31.17
CTC-1704827	125 mm	53.72
CTC-0965169	130 mm	95.23
CTC-1709850	130 mm	95.23
CTC-2667958	130 mm	95.23
CTC-1672226	140 mm	155.06
CTC-1709851	140 mm	155.06
CTC-8C9189	140 mm	155.06
CTC-1672229	150 mm	101.64
CTC-1709853	150 mm	101.64

## 3 PIECE BUFFER RINGS

Part Number	Rod Dia.	List Price
CTC-2332616	50 mm	\$ 7.41
CTC-2332615	55 mm	7.41
CTC-1505840	80 mm	64.24
CTC-4I3611	85 mm	67.81
CTC-1052576	90 mm	71.36
CTC-1076257	100 mm	82.02
CTC-4I3626	100 mm	82.02
CTC-1140704	105 mm	85.58

## RETAINER RINGS

Part Number	List Price
CTC-0950930	\$ 2.57
CTC-1H8397	4.08
CTC-2D0830	8.89
CTC-8H8024	7.50
CTC-9H5604	7.56
CTC-9H7668	1.45

# REPLACEMENT PARTS FOR CATERPILLAR® EQUIPMENT

**NOTE:** CATERPILLAR® part numbers are used as a reference only. We do not imply that these kits are original REPLACEMENT PARTS.

## 2 PIECE PISTON SEALS

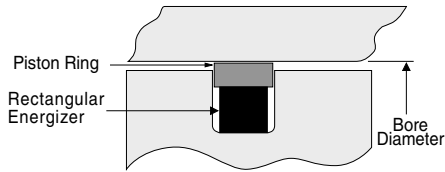

Part Number	Bore Dia.	List Price
CTC-5J7004	2	\$ 11.11
CTC-5J7004A	2	10.87
CTC-1U3998	2-1/4	13.72
CTC-1U3998A	2-1/4	13.72
CTC-8J6213	2-1/2	13.22
CTC-8J6213A	2-1/2	12.94
CTC-5J7010	2-3/4	20.19
CTC-5J7010A	2-3/4	19.76
CTC-6J1972	3	14.87
CTC-6J1972A	3	14.55
CTC-2443839	3-1/4	87.66
CTC-6J0793	3-1/4	21.10
CTC-6J0793A	3-1/4	20.65
CTC-5J7013A	3-1/2	17.64
CTC-5J8011	3-3/4	26.86
CTC-5J8011A	3-3/4	26.28
CTC-5J5402	4	20.89
CTC-5J5402A	4	20.44
CTC-5J7854	4-1/4	22.57
CTC-5J7854A	4-1/4	22.08
CTC-5J4986	4-1/2	26.07
CTC-5J4986A	4-1/2	25.51
CTC-5J4987	4-3/4	28.49
CTC-5J4987A	4-3/4	27.88
CTC-5J5020	5	30.87
CTC-5J5020A	5	30.21
CTC-5J7234A	5-1/4	36.02
CTC-5J4988A	5-1/2	35.69
CTC-9J4981A	5-3/4	51.20
CTC-5J4989	6	34.88
CTC-5J4989A	6	34.13
CTC-5J4990	6-1/4	37.50
CTC-5J4990A	6-1/4	34.88
CTC-5J4991	6-1/2	40.03

## 2 PIECE PISTON SEALS

Part Number	Bore Dia.	List Price
CTC-5J4991A	6-1/2	\$ 39.17
CTC-5J4997	7	43.40
CTC-5J4997A	7	42.47
CTC-5J4993	7-1/4	38.98
CTC-5J4993A	7-1/4	38.14
CTC-9J7117A	7-1/2	74.75
CTC-5J7016	7-3/4	103.25
CTC-5J7016A	7-3/4	103.25
CTC-5J5559A	8-1/4	48.25
CTC-6J9385A	8-1/2	53.56
CTC-5J7019	9-1/4	61.58
CTC-5J7019A	9-1/4	60.25
CTC-1214179	10	182.59
CTC-1674004	50 mm	10.67
CTC-1449485	60 mm	13.37
CTC-1980659	60 mm	12.68
CTC-1403750	65 mm	33.65
CTC-1617144	65 mm	15.97
CTC-1617145	70 mm	16.07
CTC-1754721	70 mm	35.16
CTC-1200890	75 mm	22.47
CTC-2107029	75 mm	34.66
CTC-1463923	80 mm	35.82
CTC-1931394	80 mm	38.74
CTC-1463968	85 mm	36.84
CTC-1617149	85 mm	31.29
CTC-1934313	85 mm	32.02
CTC-2107026	85 mm	36.84
CTC-2332584	85 mm	31.29
CTC-1445287	90 mm	32.03
CTC-1931368	90 mm	45.24
CTC-0963893	110 mm	53.37
CTC-0967803	120 mm	54.65
CTC-0961564	125 mm	54.65
CTC-0861345	130 mm	56.55
CTC-2344583	135 mm	63.86
CTC-0961570	140 mm	64.57
CTC-8C9193	150 mm	101.64

## 2 PIECE STEP-CUT PISTON SEALS

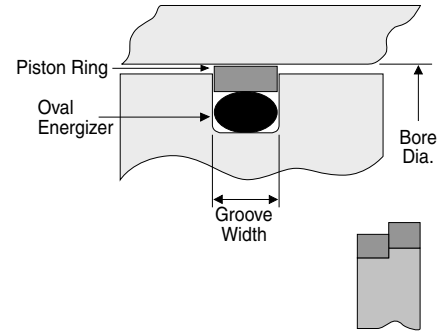

Part Number	Bore Dia.	Groove Width	List Price
CTC-1665295	2-3/4	0.19	\$ 32.71
CTC-4T8054	3-1/2	0.19	35.81
CTC-8C9160	4	0.25	41.63
CTC-9X7269	4-1/2	0.25	62.96
CTC-9X7264	5	0.38	50.70
CTC-1546744	5-3/8		48.85
CTC-8T0763	5-1/4	0.38	41.36
CTC-6E0465	5-1/2	0.38	63.39
CTC-4T5173	5-1/2	0.63	38.82
CTC-4T4144	6	0.63	43.02
CTC-4T8695	6-1/2	0.63	44.93
CTC-8T1789	7	0.63	37.12
CTC-8T1792	7-3/4	0.63	44.19
CTC-9T0119	8-1/2	0.63	67.69
CTC-8T1793	8-1/4	0.63	66.80
CTC-8T1794	10	0.69	108.37
CTC-8T1795	10-1/4	.069	111.27
CTC-8T1796	10-1/2	0.69	113.11
CTC-8T1797	11-1/2	0.69	142.58
CTC-1921453	12-1/2		167.48
CTC-1846970	75 mm		58.09
CTC-1841687	85 mm		31.79
CTC-2332585	100 mm		35.82
CTC-9X7298	100 mm	7.24 mm	86.59
CTC-9X7301	110 mm	7.24 mm	102.79
CTC-9X3589	115 mm	7.24 mm	40.46
CTC-9X3592	120 mm	7.24 mm	102.79
CTC-9X3595	130 mm	7.24 mm	102.79
CTC-2371934	135 mm	7.24 mm	100.63
CTC-9X3598	140 mm	9.63 mm	93.61
CTC-9X3601	150 mm	9.63 mm	93.02
CTC-9X3604	160 mm	9.63 mm	93.02
CTC-9X3607	170 mm	9.63 mm	100.15
CTC-9X3610	180 mm	9.63 mm	100.13

CATERPILLAR®



# REPLACEMENT PARTS FOR CATERPILLAR® EQUIPMENT

**NOTE:** CATERPILLAR® part numbers are used as a reference only. We do not imply that these kits are original REPLACEMENT PARTS.

## 5 PIECE PISTON SEALS

Part Number	Bore Dia.	List Price
CTC-0931488	90 mm	\$ 108.73
CTC-5W6382	110 mm	25.68
CTC-A04601216	120 mm	139.76
CTC-8Q5983	140 mm	43.13
CTC-1843474	150 mm	37.09

## NON CATERPILLAR® PISTON SEALS

Part Number	Bore Dia.	List Price
CTC-3E4244	1	\$ 4.58
CTC-3E4245	1-1/8	6.11
CTC-3E4246	1-1/4	5.05
CTC-3E4247	1-1/2	5.26
CTC-3E4248	1-5/8	5.35
CTC-3E4249	1-3/4	5.48
CTC-3E4250	2	5.69
CTC-3E4251	2-1/4	5.91
CTC-3E4252	2-1/2	5.98
CTC-3E4253	2-3/4	6.04
CTC-3E4254	3	6.21
CTC-3E4255	3-1/4	6.31
CTC-3E4256	3-1/2	6.49

## CAPPED PISTON T-SEALS

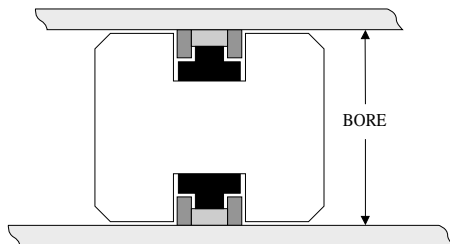

Part Number	Bore Dia.	List Price
CTC-8J3747	4-1/2	\$ 105.37
CTC-9J7868	5	128.75
CTC-8J8767	5-1/2	144.47

## CAPPED PISTON T-SEALS

Part Number	Bore Dia.	List Price
CTC-9J1242	6	\$ 150.95
CTC-9J5558	6-1/4	154.18
CTC-8J8703	6-1/2	170.11
CTC-8J3749	7	175.40
CTC-8J4510	7-1/4	181.10
CTC-9J5567	7-1/2	183.65
CTC-8J5644	7-3/4	191.33
CTC-8J4390	8-1/4	204.11
CTC-3G4762	8-1/2	214.10
CTC-9J3406	10	253.99
CTC-3G4765	10-1/2	274.32
CTC-9J2987	11-1/2	312.24
CTC-2508729	75 mm	47.47
CTC-0996998	80 mm	53.74
CTC-2639886	85 mm	61.17
CTC-0996973	90 mm	60.55
CTC-2773389	95 mm	61.17
CTC-5I5928	100 mm	65.41
CTC-0996922	110 mm	69.62
CTC-A04601713	110 mm	69.62
CTC-A04601719	160 mm	121.96

## OVERSIZED HEAD SEALS

Part Number	Bore Dia.	List Price
CTC-8C4889	2-1/2	\$ 8.89
CTC-8C4890	2-3/4	8.94
CTC-8T8367	3	9.00
CTC-8C4891	3-1/4	9.06
CTC-8T8367	3-3/4	9.00
CTC-8T8373	4-3/4	13.23
CTC-8T8374	5	39.74
CTC-8T8376	5-1/2	51.44
CTC-8T8377	6	50.99
CTC-8T8379	6-1/2	52.49
CTC-8T8380	7	54.14
CTC-8T8381	7-1/4	26.06

## OVERSIZED HEAD SEALS

Part Number	Bore Dia.	List Price
CTC-8C0553	7-1/2	\$ 12.61
CTC-8C4892	7-3/4	34.11
CTC-8T8382	8-1/4	22.23
CTC-8C4893	8-1/2	62.30
CTC-8C4896	10-1/4	18.33
CTC-8C4897	10-1/2	21.83
CTC-8C4898	11-1/2	29.78

## WEAR RINGS

Part Number	O.D. X Width	List Price
CTC-5J9073	1-1/2 X 0.485	\$ 6.56
CTC-8C9120	1-5/8 X 13/16	10.79
CTC-4T6780	1-5/8 X .98	9.22
CTC-8T5443	1-5/8 X 1-1/4	19.39
CTC-4T6907	1-7/8 X .98	22.67
CTC-8T6441	2 X 1/4	20.29
CTC-5J7942	2 X 1/2	4.69
CTC-8T6442	2 X .72	23.00
CTC-4T6779	2 X .98	30.24
CTC-4T5613	2-1/8 X 1	6.12
CTC-8T7030	2-1/8 X 1-1/4	28.96
CTC-8T6682	2-1/4 X .36	48.05
CTC-8T6681	2-1/4 X .72	47.34
CTC-7H2423	2-1/4 X 7/8	7.55
CTC-4T6128	2-1/4 X .98	26.50
CTC-8T4958	2-3/8 X 1	34.13
CTC-8T8204	2-3/8 X 1-3/16	30.50
CTC-8J6212	2-1/2 X 3/4	8.87
CTC-9X7260	2-1/2 X 1.246	16.67
CTC-009004097	2.51 X 3.11	37.73
CTC-8T0785	2-5/8 X .98	33.11
CTC-8T5668	2-5/8 X 1-1/4	37.95
CTC-8T8394	2-5/8 X 1-11/16	48.46
CTC-8T8365	2.7 X 2.28	72.73
CTC-8J0112	2-3/4 X 15/16	12.65
CTC-8T7372	2-3/4 X .97	13.74
CTC-8C9200	2-7/8 X 1	41.06
CTC-8C9114	2-7/8 X 1	41.06
CTC-6C2385	2-7/8 X 1-1/4	34.46
CTC-8T7849	2-7/8 X 1.57	47.98
CTC-8T7020	2-7/8 X 1-13/16	31.21

# REPLACEMENT PARTS FOR CATERPILLAR® EQUIPMENT

**NOTE:** CATERPILLAR® part numbers are used as a reference only. We do not imply that these kits are original REPLACEMENT PARTS.

## WEAR RINGS

Part Number	O.D. X Width	List Price
CTC-8T6743	2.95 X 1.96	\$ 61.08
CTC-2233353	3 X 3/4	4.91
CTC-6J5733	3 X .99	15.85
CTC-8T6443	3 X 1	14.74
CTC-4T7283	3 X 1.24	22.21
CTC-8C9161	3-1/8 X .97	14.61
CTC-9T0094	3-1/8 X 1.24	68.29
CTC-8T1714	3-1/8 X 1-9/16	75.70
CTC-8T7584	3-1/8 X 1-5/8	38.65
CTC-8C9153	3.20 X 1.17	51.80
CTC-8J2577	3-1/4 X 3/4	18.20
CTC-8J6371	3-1/4 X 1.11	17.12
CTC-8T6683	3-1/4 X 1-1/8	55.96
CTC-8T0777	3-3/8 X 1.74	68.82
CTC-2233502	3-3/8 X 3/4	4.91
CTC-8T4813	3.45 X 1-5/8	50.14
CTC-8T6745	3.45 X 1.96	56.73
CTC-8T6744	3.45 X 2.74	81.96
CTC-2233356	3-1/2 X 3/4	4.93
CTC-7J6916	3-1/2 X 5/8	4.91
CTC-6H5496	3-1/2 X 7/8	10.17
CTC-5J3326	3-1/2 X 1-1/8	30.76
CTC-7J9885	3-1/2 X 1-1/8	13.68
CTC-4J3236	3-1/2 X 1-1/2	16.02
CTC-8C5245	3-5/8 X 1.05	46.42
CTC-8T3329	3-5/8 X 1.88	55.72
CTC-8C3829	3.7 X 1.76	91.73
CTC-1324907	3.7 X 1.88	82.36
CTC-8T6746	3.7 X 2.36	64.30
CTC-2233357	3-3/4 X 3/4	12.73
CTC-8J6245	3-3/4 X 1	14.81
CTC-5J8019	3-3/4 X 1.24	15.06
CTC-6J3075	3-3/4 X 1.99	40.59
CTC-8T7848	3-7/8 X 1.57	76.18
CTC-8T3330	3.95 X 2-7/16	94.13
CTC-5J7154	4 X 5/8	15.48
CTC-8H0214	4 X 7/8	10.38
CTC-6J2797	4 X .99	19.84
CTC-6U3246	4 X 1	5.76
CTC-1M1571	4 x 1-1/4	24.22
CTC-3G4723	4-1/8 X .42	17.74
CTC-8T7538	4.2 X 1.56	78.00
CTC-8T6747	4.2 X 2.55	65.68
CTC-2259524	4-1/4 X 3/4	8.99
CTC-1194760	4-1/4 X 1	12.82

## WEAR RINGS

Part Number	O.D. X Width	List Price
CTC-6J7264	4-1/4 X 1	\$ 25.74
CTC-6J4003	4-1/4 X 1-1/4	14.10
CTC-5J8157	4-1/4 X 1.49	18.80
CTC-4T4753	4-1/4 X 1.88	30.18
CTC-7J3300	4.258 X 2.49	52.69
CTC-8T6748	4.45 X 2-3/8	73.40
CTC-2264162	4-1/2 X 3/4	13.53
CTC-2233360	4-3/4 X 3/4	16.42
CTC-5U3531	4-1/2 X 3/4	5.15
CTC-6H6270	4-1/2 X 7/8	12.17
CTC-4J4605	4-1/2 X 15/16	15.69
CTC-1460744	4-1/2 X 1	14.97
CTC-4J3745	4-1/2 X 1	14.97
CTC-6U4154	4-1/2 X 1	7.05
CTC-4J2630	4-1/2 X 1-1/2	22.09
CTC-4J2620	4-1/2 X 1-1/2	21.67
CTC-6J4175	4-1/2 X 1.86	35.85
CTC-4T8758	4-1/2 X 1.86	35.85
CTC-0901301	4-1/2 X 2.362	59.71
CTC-4T9248	4-3/4 X 1-1/4	21.06
CTC-4J3342	4-3/4 X 1-1/4	21.06
CTC-5J3326	4-3/4 X 1-1/4	30.76
CTC-1317184	4-3/4 X 1.64	38.59
CTC-3J7663	4-3/4 X 1.99	99.23
CTC-9J9792	4-3/4 X 3-1/2	61.68
CTC-4T6929	4-3/4 X 3-1/2	61.68
CTC-8T7850	4.950 X 1.96	54.86
CTC-2263860	5 X 3/4	19.99
CTC-7J1627	5 X 0.85	20.41
CTC-4J4630	5 X 1-1/8	17.57
CTC-8M4226	5 X 1.24	38.20
CTC-4J3420	5 X 1.55	18.54
CTC-4T4752	5 X 1-3/4	22.42
CTC-8T3331	5.2 X 2-1/2	91.73
CTC-7J8878	5-1/4 X 3/16	9.04
CTC-9J7978	5-1/4 X 3/4	24.78
CTC-2D0714	5-1/4 X 1.02	40.57
CTC-4J3887	5-1/4 X 1.307	13.92
CTC-9J7978	5-1/4 X 1.49	24.78
CTC-9J3054	5-1/4 X 3.61	79.06
CTC-4T5718	5.45 X 2.49	92.86
CTC-1546747	5-3/8 X 1	14.99
CTC-5U4278	5-1/2 X 3/4	5.37
CTC-4J4606	5-1/2 X 1-1/4	20.86
CTC-3J9026	5-1/2 X 1-3/8	38.85

## WEAR RINGS

Part Number	O.D. X Width	List Price
CTC-7J3303	5-1/2 X 1.61	\$ 49.42
CTC-9J7191	5-1/2 X 1.74	60.98
CTC-1898686	5-1/2 X 1-3/4	60.98
CTC-7J1731	5-1/2 X 1-3/4	26.62
CTC-4J3518	5-1/2 X 1.99	54.52
CTC-8C9112	5-1/2 X 1.99	54.52
CTC-8J1690	5-1/2 X 2.24	64.01
CTC-1724019	5-3/4 X 1.61	79.56
CTC-9J4164	5-3/4 X 1.62	79.56
CTC-6J3074	5-3/4 X 1.99	62.20
CTC-8J9917	5-3/4 X 2.36	85.19
CTC-8T7851	5.95 X 1.96	88.53
CTC-8T3332	5.95 X 3.61	138.86
CTC-7J8877	6 X 3/16	40.24
CTC-3G6537	6 X 1.07	34.77
CTC-5J0014	6 X 1-1/4	27.57
CTC-1J0708	6 X 1-5/16	29.46
CTC-9J5860	6 X 1-1/2	28.13
CTC-7J5326	6 X 1-3/4	49.71
CTC-4T6930	6 X 2.74	141.00
CTC-8J1746	6 X 2.74	141.00
CTC-8J1764	6 X 2.74	141.00
CTC-8J1714	6 X 2.86	106.28
CTC-5J3326	6-1/4 X 1.49	30.76
CTC-9J5550	6-1/4 X 1-3/4	51.36
CTC-4T9319	6-1/4 X 2.74	142.61
CTC-5J0058	6-1/2 X 1-1/4	28.22
CTC-7J8880	6-1/2 X 1/4	28.48
CTC-4J7532	6-1/2 X 1	21.48
CTC-3J9027	6-1/2 X 1.37	25.55
CTC-9T0096	6-1/2 X 1-1/2	25.68
CTC-3J9703	6-1/2 X 1-1/2	25.68
CTC-9J9806	6-1/2 X 1.74	51.12
CTC-7J1938	6-1/2 X 2	43.34
CTC-9J3055	6-1/2 X 2.74	142.61
CTC-7J9232	6-1/2 X 2.86	70.42
CTC-9J0811	6-1/2 X 3.485	137.46
CTC-7J8881	6-1/2 X 3.49	183.10
CTC-1915604	6-3/4 X 0.99	59.01
CTC-8M4228	7 X 1.485	22.86
CTC-3G5098	7 X 1.74	51.27
CTC-9J0711	7 X 1.99	53.30
CTC-3G3470	7 X 2.365	127.76
CTC-8J1662	7 X 3-1/8	52.82
CTC-8T6749	7.2 X 3.14	124.17



# REPLACEMENT PARTS FOR CATERPILLAR® EQUIPMENT

**NOTE:** CATERPILLAR® part numbers are used as a reference only. We do not imply that these kits are original REPLACEMENT PARTS.

## WEAR RINGS

Part Number	O.D. X Width	List Price
CTC-1J2674	7-1/4 X 1-3/8	\$ 56.23
CTC-3J7848	7-1/4 X 2	55.29
CTC-1U1734	7-1/4 X 3-1/16	154.30
CTC-8T7693	7-1/4 X 7.1	263.79
CTC-4J7663	7-1/4 X 7.10	263.79
CTC-8T1127	7-3/8 X 1.61	103.50
CTC-1U2218	7-1/2 X 1-1/2	44.25
CTC-8J9936	7-1/2 X 2.36	81.91
CTC-9J5562	7-1/2 X 2-1/2	78.24
CTC-4T4811	7-1/2 X 2.95	207.74
CTC-7J8886	7-3/4 X 1/4	11.62
CTC-5J5037	7-3/4 X 1.61	114.66
CTC-9J5037	7-3/4 X 1.61	114.66
CTC-9J3624	7-3/4 X 1.99	59.45
CTC-7J9247	7-3/4 X 3-1/2	134.86
CTC-4T6932	7-3/4 X 4.49	258.84
CTC-3G4625	7-3/4 X 4.49	258.84
CTC-4J9047	8 X 5	126.46
CTC-8T7695	8 X 5	126.46
CTC-6E0245	8.200 X 2.950	145.03
CTC-7J8887	8-1/4 X 1/4	25.86
CTC-2J0745	8-1/4 X 1-1/4	29.22
CTC-4J7376	8-1/4 X 1-1/2	41.54
CTC-3J8683	8-1/4 X 1-3/4	50.83
CTC-3G9882	8-1/4 X 1.99	126.89
CTC-8J8375	8-1/4 X 2-1/8	78.75
CTC-3J7632	8-1/4 X 2-1/4	84.20
CTC-7J3301	8-1/4 X 2.49	129.43
CTC-8J8826	8-1/4 X 2.74	104.40
CTC-9J8102	8-1/4 X 2.74	175.02
CTC-8T7694	8-1/2 X 3	129.97
CTC-4T9320	8-1/4 X 3-1/2	181.14
CTC-9J3056	8-1/4 X 4.11	89.10
CTC-7J8064	8-1/2 X 2.36	113.89
CTC-9M1604	8-1/2 X 3	129.97
CTC-1J5281	9-1/4 X 1-3/4	35.69
CTC-4T5949	9-1/4 X 1.96	81.59
CTC-7J2087	9-1/4 X 2-1/4	129.55
CTC-8C3846	9-3/8 X 9	1467.25
CTC-4T6097	9-1/2 X 1.93	177.02
CTC-1214175	10 X 1.9	88.29
CTC-1178865	10 X 1-1/2	34.98
CTC-8C3843	10 X 2.74	132.65
CTC-9J3369	10 X 3-1/4	102.85
CTC-7J8890	10-1/4 X 0.243	27.24

## WEAR RINGS

Part Number	O.D. X Width	List Price
CTC-2299443	10-1/2 X 2.382	\$ 120.60
CTC-9J1159	10 1/2 X 2.74	174.52
CTC-8J8900	10-1/2 X 3-3/4	103.26
CTC-8J5980	10-1/2 X 4	147.56
CTC-8T6637	10-3/4 X 6-1/2	1600.92
CTC-6E0249	11 X 1.923	94.91
CTC-9J2991	11-1/2 X 3-7/8	113.35
CTC-4T6096	12-1/4 X 4	274.49
CTC-1U2694	12-1/2 X 4	199.16
CTC-6E0308	12-1/2 X 1.460	120.26
CTC-1530119	12-3/4 X 4	227.21
CTC-8T1130	12-7/8 X 2.86	373.99
CTC-4T4827	12-7/8 X 12.18	860.46
CTC-1U4627	13-1/8 X 7.85	730.52
CTC-6E0247	13-3/4 X 4	250.66
CTC-4T4129	14-1/4 X 3.99	261.71
CTC-4T4825	15-1/8 X 7.71	646.44
CTC-9X3564	16-1/8 X 7.69	611.03
CTC-1449482	33 X 14.2 mm	6.76
CTC-1473779	38 X 14.2 mm	6.89
CTC-1449494	43 X 14.2 mm	5.80
CTC-1509403	48 X 14.2 mm	7.18
CTC-1410709	53 X 24.5 mm	14.59
CTC-0908007	55 X 7.9 mm	18.31
CTC-1449486	60 X 14.8 mm	7.81
CTC-1980663	60 X 18 mm	5.75
CTC-1890589	63 X 20 mm	10.83
CTC-1400176	63 X 24.8 mm	24.97
CTC-2377904	65 X 6 mm	9.22
CTC-1449491	65 X 14.8 mm	8.05
CTC-2377088	70 X 6 mm	9.99
CTC-1404272	70 X 11.8 mm	73.28
CTC-1512566	70 X 14.8 mm	8.05
CTC-1057252	71.3 X 5.9 mm	33.16
CTC-1991142	75 X 6 mm	23.31
CTC-2812315	75 X 6 mm	23.31
CTC-1930783	75 X 9.8 mm	2.47
CTC-2508733	75 X 10 mm	10.77
CTC-1509402	75 X 14.8 mm	8.24
CTC-1438918	75 X 29.8 mm	19.79
CTC-0997003	80 X 6 mm	63.29
CTC-2376136	80 X 6 mm	11.52
CTC-1931393	80 X 10 mm	3.41
CTC-1052630	81.3 X 5.9 mm	36.31
CTC-2781986	85 X 6 mm	27.78

## WEAR RINGS

Part Number	O.D. X Width	List Price
CTC-1934312	85 X 9.8 mm	\$ 2.83
CTC-2639887	85 X 12.5 mm	7.62
CTC-1463967	85 X 14.8 mm	128.79
CTC-1512565	85 X 15 mm	17.33
CTC-1931367	90 X 10 mm	13.01
CTC-1057388	91.3 X 5.9 mm	9.57
CTC-2773390	95 X 12.5 mm	5.66
CTC-1522463	95 X 14.8 mm	55.31
CTC-0931628	100 X 5.9 mm	72.59
CTC-1438033	100 X 5.9 mm	17.97
CTC-1438025	100 X 6 mm	33.01
CTC-2835953	100 X 9 mm	6.19
CTC-1931769	100 X 10 mm	5.26
CTC-2332589	100 X 12.5 mm	13.45
CTC-1438024	100 X 22.4 mm	25.83
CTC-2332588	100 X 25 mm	17.43
CTC-0931605	100 X 30 mm	10.34
CTC-1195456	100 X 30 mm	15.56
CTC-1079306	105 x 15 mm	42.17
CTC-0931629	110 X 5.9 mm	79.26
CTC-1438031	110 X 5.9 mm	15.61
CTC-1438034	110 X 5.9 mm	19.15
CTC-1600033	110 X 5.9 mm	79.26
CTC-1505845	110 X 7.9 mm	10.52
CTC-2478994	110 X 7.9 mm	12.24
CTC-0931603	110 X 30 mm	26.87
CTC-1195434	110 X 30 mm	22.99
CTC-A04901911	110 X 30 mm	26.87
CTC-1336678	110 X 35 mm	23.87
CTC-1438027	120 X 5.9 mm	16.71
CTC-1438035	120 X 5.9 mm	19.83
CTC-1261936	120 X 7.9 mm	11.33
CTC-1663003	120 X 7.9 mm	11.69
CTC-2478865	120 X 7.9 mm	11.33
CTC-0860255	120 X 8 mm	47.08
CTC-1589063	120 X 15.5 mm	19.84
CTC-1475837	120 X 27.35 mm	36.98
CTC-1195445	120 X 30 mm	23.89
CTC-1184130	120 X 35 mm	45.75
CTC-0961565	125 X 8 mm	49.06
CTC-1261871	130 X 7.9 mm	12.60
CTC-1475853	130 X 7.9 mm	18.65
CTC-1505884	130 X 7.9 mm	21.85
CTC-2479006	130 X 7.9 mm	12.60
CTC-419392	130 X 7.9 mm	12.60

# REPLACEMENT PARTS FOR CATERPILLAR® EQUIPMENT

**NOTE:** CATERPILLAR® part numbers are used as a reference only. We do not imply that these kits are original REPLACEMENT PARTS.

## WEAR RINGS

Part Number	O.D. X Width	List Price
CTC-0861346	130 X 8 mm	\$ 49.93
CTC-7Y4632	130 X 8 mm	49.93
CTC-1704829	130 X 15 mm	47.27
CTC-1799771	130 X 18.1 mm	35.03
CTC-1184019	130 X 40 mm	56.33
CTC-7Y4636	130 X 40 mm	56.33
CTC-2344485	135 X 7.75 mm	36.07
CTC-2344585	135 X 7.9 mm	13.91
CTC-2344586	135 X 8 mm	50.87
CTC-2344483	135 X 18.1 mm	17.59
CTC-0961571	140 X 8 mm	51.51
CTC-0961800	140 X 8 mm	51.51
CTC-1076264	140 X 8 mm	51.51
CTC-1076263	140 X 9.5 mm	22.70
CTC-1261877	140 X 9.5 mm	22.70
CTC-2478874	140 X 9.5 mm	22.70
CTC-1645168	140 X 19.5 mm	90.72
CTC-1589065	140 X 20.35 mm	49.75
CTC-1183995	140 X 45 mm	61.04
CTC-1884218	150 X 7.8 mm	17.20
CTC-0961581	150 X 7.9 mm	105.58
CTC-1140713	150 X 8 mm	56.88
CTC-1948357	150 X 9.5 mm	15.23
CTC-2344574	150 X 9.5 mm	15.23
CTC-1873464	150 X 20 mm	26.87
CTC-1163589	150 X 45 mm	64.64
CTC-0963201	160 X 8.9 mm	140.23
CTC-1850231	160 X 8.9 mm	10.99
CTC-1850230	160 X 20.5 mm	37.49
CTC-1183944	160 X 45 mm	67.89
CTC-1915605	170 X 9.2 mm	9.37
CTC-1057262	170 X 50 mm	94.35
CTC-0965167	180 X 8.9 mm	133.15
CTC-1475787	180 X 8.9 mm	16.67
CTC-1438138	180 X 28 mm	51.40
CTC-1052653	180 X 55 mm	106.77
CTC-1261976	190 X 8.9 mm	89.04
CTC-2042846	190 X 9.2 mm	13.37
CTC-2042845	190 X 28.5 mm	53.46
CTC-1261974	190 X 55 mm	85.02
CTC-1475776	200 X 9 mm	21.12
CTC-9X3570	200 X 59.8 mm	78.04
CTC-1704828	220 X 15 mm	70.90
CTC-6E0496	220 X 59.8 mm	78.04

## SILICONE O-RINGS

Part Number	Min. Pkgs.	List Price
CTC-1M6036	2	\$ 6.64
CTC-1S0004	5	3.36
CTC-1S2174	5	2.88
CTC-1S7462	6	1.01
CTC-1S9799	6	1.75
CTC-2M2561	3	5.46
CTC-2P3538	5	4.43
CTC-2S2251	5	5.77
CTC-3S4489	5	1.33
CTC-5H7153	4	3.41
CTC-5H8853	20	0.39
CTC-5M3038	5	3.72
CTC-5P4932	11	1.22
CTC-5P6436	11	0.60
CTC-5P6620	20	0.58
CTC-6F0249	4	1.44
CTC-6L1648	4	3.68
CTC-6L1649	3	4.74
CTC-6L1650	3	3.96
CTC-6L1651	3	6.20
CTC-6L9284	3	4.58
CTC-7X4800	20	0.57
CTC-8M1112	6	1.18
CTC-8M4389	5	1.03
CTC-8M4390	3	3.96
CTC-8M4395	3	3.02
CTC-8M4431	4	1.05
CTC-8M4432	5	2.05
CTC-8M4435	5	1.54
CTC-8M4436	3	3.63
CTC-8M4437	10	0.86
CTC-8M4438	5	0.90
CTC-8M4443	3	3.27
CTC-8M4445	5	1.72
CTC-8M4446	5	1.82
CTC-8M4447	6	0.85
CTC-8M4448	5	1.03
CTC-8M4986	10	2.99
CTC-8M4987	10	2.59
CTC-8M4988	5	2.03
CTC-8M4989	2	4.48
CTC-8M4990	3	2.99

## SILICONE O-RINGS

Part Number	Min. Pkgs.	List Price
CTC-8M4991	3	\$ 4.69
CTC-8M4992	3	3.58
CTC-8M5010	3	3.79
CTC-8M5127	12	0.55
CTC-8M5248	5	2.24
CTC-8M5249	5	2.75
CTC-8M5251	12	0.74
CTC-8M5252	3	4.57
CTC-8M5253	8	0.64
CTC-8M5254	5	2.39
CTC-8M5260	8	0.62
CTC-8M5661	3	3.41
CTC-8M8157	5	0.80
CTC-8M8281	5	1.23
CTC-8M8282	6	1.00
CTC-8M8283	3	1.14
CTC-8M8515	5	1.80
CTC-9H6067	5	3.63
CTC-9M4218	2	5.17
CTC-9M4849	5	3.84
CTC-9M7002	3	5.32
CTC-9M7539	3	3.55
CTC-9M9647	3	5.57

## DUST SEALS

Part Number	Rod Dia.	List Price
CTC-1920638	40 mm	\$ 8.53
CTC-2725645	50 mm	5.61
CTC-2725665	45 mm	4.95
CTC-2773392	50 mm	5.61
CTC-2774134	45 mm	4.95

# REPLACEMENT PARTS FOR CATERPILLAR® EQUIPMENT

**NOTE:** CATERPILLAR® part numbers are used as a reference only. We do not imply that these kits are original REPLACEMENT PARTS.

## SHIMS

Part Number	List Price
CTC-0964441	\$ 13.00
CTC-0964477	12.13
CTC-0965741	10.63
CTC-1076265	10.63

## D-RINGS

Part Number	I.D.	List Price
CTC-1P3700	19 mm	\$ 1.34
CTC-1P3702	25.4 mm	1.51
CTC-1P3703	31.9 mm	1.80
CTC-1P3704	38.2 mm	1.94
CTC-1P3705	44.7 mm	2.09
CTC-1P3706	51.1 mm	2.23
CTC-1P3707	54.2 mm	2.28
CTC-1P3708	57.4 mm	2.42
CTC-1P3709	63.9 mm	2.53

## O-RINGS

Part Number	Min. Pkgs.	List Price
CTC-0032770	1	\$ 4.02
CTC-0038137	50	0.12
CTC-0041963	20	0.35
CTC-0041964	20	0.45
CTC-0058592	50	0.25
CTC-0058593	20	0.29
CTC-0068350	1	4.79
CTC-0068352	10	0.76
CTC-0082103	50	0.26
CTC-0092061	3	2.36
CTC-0304605	50	0.10
CTC-0304606	10	0.98
CTC-0314392	5	2.32
CTC-0329714	20	0.55
CTC-0329882	20	0.28
CTC-0335853	10	1.04
CTC-0335879	1	0.40

## O-RINGS

Part Number	Min. Pkgs.	List Price
CTC-0336027	10	\$ 1.77
CTC-0336031	2	4.26
CTC-0336032	15	0.64
CTC-0336033	20	0.40
CTC-0336034	10	0.92
CTC-0336038	3	2.95
CTC-0336039	15	0.75
CTC-0336041	10	1.44
CTC-0336042	10	1.11
CTC-0336044	15	0.51
CTC-0350273	2	5.02
CTC-0617538	30	0.35
CTC-0617539	5	1.18
CTC-0617540	3	2.25
CTC-0618341	3	3.28
CTC-0618561	2	3.51
CTC-0618639	15	0.64
CTC-0619455	3	2.85
CTC-0619456	2	3.38
CTC-0619457	2	3.91
CTC-0619458	5	1.68
CTC-0619729	1	4.07
CTC-0689002	5	1.58
CTC-0773241	50	0.12
CTC-0775843	20	0.41
CTC-0857537	50	0.14
CTC-0857538	50	0.29
CTC-0857539	50	0.26
CTC-0857540	20	0.47
CTC-0858219	1	4.02
CTC-0922304	25	0.35
CTC-0931344	1	14.41
CTC-0951508	100	0.09
CTC-0951509	100	0.09
CTC-0951510	100	0.09
CTC-0951511	100	0.11
CTC-0951512	100	0.11
CTC-0951513	100	0.11
CTC-0951514	100	0.11
CTC-0951515	100	0.09

## O-RINGS

Part Number	Min. Pkgs.	List Price
CTC-0951516	100	\$ 0.53
CTC-0951517	100	0.11
CTC-0951518	100	0.74
CTC-0951519	100	0.11
CTC-0951521	100	0.93
CTC-0951522	100	0.12
CTC-0951524	100	0.13
CTC-0951525	25	1.13
CTC-0951526	25	1.20
CTC-0951527	25	0.35
CTC-0951528	25	0.44
CTC-0951530	20	0.46
CTC-0951531	20	0.46
CTC-0951532	20	0.47
CTC-0951533	20	0.47
CTC-0951534	20	0.58
CTC-0951536	20	2.30
CTC-0951537	20	0.62
CTC-0951538	20	0.62
CTC-0951539	20	2.70
CTC-0951540	20	2.70
CTC-0951541	20	0.65
CTC-0951543	10	0.85
CTC-0951544	10	0.85
CTC-0951545	10	0.87
CTC-0951546	5	2.28
CTC-0951547	10	0.90
CTC-0951549	2	3.27
CTC-0951550	2	4.16
CTC-0951551	2	4.17
CTC-0951552	2	4.46
CTC-0951553	2	4.56
CTC-0951554	2	4.73
CTC-0951555	2	4.83
CTC-0951556	2	5.00
CTC-0951557	2	5.10
CTC-0951558	2	6.63
CTC-0951559	2	6.68
CTC-0951560	2	6.74
CTC-0951561	2	6.98



# REPLACEMENT PARTS FOR CATERPILLAR® EQUIPMENT

**NOTE:** CATERPILLAR® part numbers are used as a reference only. We do not imply that these kits are original REPLACEMENT PARTS.

CATERPILLAR®

## O-RINGS

Part Number	Min. Pkgs.	List Price
CTC-0951562	2	\$ 7.02
CTC-0951563	2	7.24
CTC-0951564	2	7.36
CTC-0951565	1	13.90
CTC-0951566	1	14.26
CTC-0951567	1	16.00
CTC-0951568	1	27.41
CTC-0951569	1	28.84
CTC-0951571	100	0.08
CTC-0951572	100	0.11
CTC-0951573	100	0.11
CTC-0951574	50	0.22
CTC-0951575	50	0.24
CTC-0951576	50	0.24
CTC-0951577	25	0.39
CTC-0951578	50	0.25
CTC-0951579	25	0.40
CTC-0951580	25	0.40
CTC-0951581	20	0.53
CTC-0951583	20	0.54
CTC-0951584	20	0.54
CTC-0951585	20	0.55
CTC-0951587	20	0.72
CTC-0951589	20	0.44
CTC-0951590	20	0.74
CTC-0951591	20	0.54
CTC-0951592	20	0.70
CTC-0951593	20	0.70
CTC-0951594	10	0.91
CTC-0951595	10	0.91
CTC-0951597	10	1.16
CTC-0951598	10	1.20
CTC-0951599	10	1.22
CTC-0951600	10	1.28
CTC-0951601	10	1.28
CTC-0951602	10	1.29
CTC-0951603	10	1.36
CTC-0951604	10	1.38
CTC-0951605	10	1.40
CTC-0951606	10	1.45

## O-RINGS

Part Number	Min. Pkgs.	List Price
CTC-0951608	5	\$ 1.57
CTC-0951609	5	1.59
CTC-0951610	5	2.03
CTC-0951611	5	2.09
CTC-0951612	5	2.30
CTC-0951613	5	2.10
CTC-0951615	5	2.40
CTC-0951616	5	2.45
CTC-0951617	5	2.46
CTC-0951618	2	3.26
CTC-0951621	2	4.14
CTC-0951623	2	4.62
CTC-0951624	2	4.72
CTC-0951625	2	4.83
CTC-0951626	2	5.00
CTC-0951627	2	5.10
CTC-0951628	2	6.65
CTC-0951629	2	6.71
CTC-0951630	2	6.79
CTC-0951631	2	6.87
CTC-0951632	2	6.92
CTC-0951633	2	7.07
CTC-0951634	2	7.21
CTC-0951635	2	8.76
CTC-0951636	1	15.91
CTC-0951637	1	17.83
CTC-0951639	1	19.85
CTC-0951640	1	20.68
CTC-0951641	1	21.21
CTC-0951642	1	40.50
CTC-0951657	25	0.35
CTC-0951658	20	0.46
CTC-0951659	20	0.61
CTC-0951662	10	3.09
CTC-0951663	10	0.98
CTC-0951671	5	7.18
CTC-0951673	5	2.02
CTC-0951674	5	8.63
CTC-0951675	5	2.62
CTC-0951676	5	2.73

## O-RINGS

Part Number	Min. Pkgs.	List Price
CTC-0951678	5	\$ 9.35
CTC-0951679	2	10.38
CTC-0951680	2	10.72
CTC-0951681	2	3.37
CTC-0951682	2	5.49
CTC-0951683	2	5.53
CTC-0951684	2	5.69
CTC-0951685	2	14.39
CTC-0951686	2	7.83
CTC-0951687	2	7.89
CTC-0951688	2	7.98
CTC-0951689	2	9.31
CTC-0951690	2	9.48
CTC-0951691	2	9.67
CTC-0951692	1	9.82
CTC-0951693	1	11.30
CTC-0951694	1	13.21
CTC-0951695	1	14.05
CTC-0951696	25	0.39
CTC-0951698	20	0.52
CTC-0951700	20	0.64
CTC-0951704	10	1.48
CTC-0951705	10	1.54
CTC-0951706	5	1.77
CTC-0951707	5	1.76
CTC-0951708	5	1.78
CTC-0951709	5	6.85
CTC-0951710	5	1.72
CTC-0951711	5	2.22
CTC-0951712	5	2.24
CTC-0951713	5	7.18
CTC-0951714	5	2.50
CTC-0951715	5	2.56
CTC-0951716	5	8.63
CTC-0951717	5	2.62
CTC-0951718	5	2.73
CTC-0951719	5	9.35
CTC-0951720	5	2.93
CTC-0951721	2	10.38
CTC-0951722	2	6.13



# REPLACEMENT PARTS FOR CATERPILLAR® EQUIPMENT

**NOTE:** CATERPILLAR® part numbers are used as a reference only. We do not imply that these kits are original REPLACEMENT PARTS.

O-RINGS			O-RINGS			O-RINGS		
Part Number	Min. Pkgs.	List Price	Part Number	Min. Pkgs.	List Price	Part Number	Min. Pkgs.	List Price
CTC-0951723	2	\$ 3.52	CTC-1073117	10	\$ 1.26	CTC-1183125	5	\$ 3.63
CTC-0951724	2	7.51	CTC-1074057	20	0.45	CTC-1183128	5	2.44
CTC-0951725	2	8.94	CTC-1076259	5	3.09	CTC-1183131	10	1.37
CTC-0951726	2	9.32	CTC-1077642	20	0.52	CTC-1197843	20	0.66
CTC-0951727	1	11.29	CTC-1085803	10	0.98	CTC-1197844	20	0.91
CTC-0951728	1	11.39	CTC-1085806	2	5.42	CTC-1197845	5	3.32
CTC-0951729	1	11.59	CTC-1092332	1	6.75	CTC-1199443	8	0.87
CTC-0951730	1	12.94	CTC-1092333	14	0.77	CTC-1217687	20	0.61
CTC-0951731	1	13.23	CTC-1093203	15	1.04	CTC-1218094	5	1.74
CTC-0951732	1	17.23	CTC-1093205	3	2.36	CTC-1218112	100	0.11
CTC-0951733	1	20.43	CTC-1093206	10	1.06	CTC-1218117	10	0.77
CTC-0951734	1	24.28	CTC-1095694	1	0.79	CTC-1228352	50	0.14
CTC-0951735	1	25.16	CTC-1095698	10	1.53	CTC-1229251	5	2.32
CTC-0951736	1	29.01	CTC-1095700	5	2.05	CTC-1232341	100	0.09
CTC-0951737	1	31.18	CTC-1095702	1	8.57	CTC-1232342	100	0.23
CTC-0951738	1	33.02	CTC-1095704	5	2.74	CTC-1232343	10	0.96
CTC-0951739	1	40.74	CTC-1097411	1	26.92	CTC-1241858	2	3.38
CTC-0951750	50	0.11	CTC-1097412	20	0.45	CTC-1241859	2	5.41
CTC-0951751	50	0.14	CTC-1099685	10	0.97	CTC-1249346	50	0.24
CTC-0951753	20	0.71	CTC-1104742	1	1.44	CTC-1251372	10	0.96
CTC-0958859	2	6.52	CTC-1117052	5	2.87	CTC-1254194	1	4.53
CTC-0960034	25	0.33	CTC-1120033	100	0.06	CTC-1259701	5	1.73
CTC-0960035	1	21.50	CTC-1120034	100	0.11	CTC-1259794	1	7.75
CTC-0960037	1	62.48	CTC-1123102	15	0.64	CTC-1264002	1	7.74
CTC-0960071	2	6.87	CTC-1123540	2	3.34	CTC-1264003	1	5.38
CTC-0960121	5	2.32	CTC-1126920	1	10.06	CTC-1266514	3	3.07
CTC-0963944	1	12.34	CTC-1132073	1	22.51	CTC-1266515	3	3.07
CTC-0964921	2	5.56	CTC-1135304	1	6.08	CTC-1266516	1	3.09
CTC-0965382	2	6.92	CTC-1137820	20	0.80	CTC-1300229	1	8.80
CTC-0965572	10	1.37	CTC-1137822	10	1.54	CTC-1313715	20	0.77
CTC-0966100	20	0.32	CTC-1149275	5	1.58	CTC-1313716	5	2.48
CTC-0967041	2	6.51	CTC-1163682	10	1.24	CTC-1313718	2	5.83
CTC-0990187	20	0.28	CTC-1171266	10	1.23	CTC-1323056	2	6.68
CTC-0994780	10	1.07	CTC-1171495	20	0.65	CTC-1324240	5	1.62
CTC-0994846	1	26.25	CTC-1177273	20	0.45	CTC-1334771	50	0.30
CTC-0998232	50	0.26	CTC-1177282	5	2.95	CTC-1345691	2	3.33
CTC-1020889	1	6.69	CTC-1178801	1	6.54	CTC-1356950	1	29.52
CTC-1038254	10	0.84	CTC-1178803	5	1.50	CTC-1357935	5	1.82
CTC-1038255	5	1.78	CTC-1182720	5	1.84	CTC-1362942	1	13.96
CTC-1073114	1	18.44	CTC-1183122	5	1.70	CTC-1367227	8	1.41

CATERPILLAR®



# REPLACEMENT PARTS FOR CATERPILLAR® EQUIPMENT

**NOTE:** CATERPILLAR® part numbers are used as a reference only. We do not imply that these kits are original REPLACEMENT PARTS.

CATERPILLAR®

## O-RINGS

Part Number	Min. Pkgs.	List Price
CTC-1374350	1	\$ 56.68
CTC-1376667	10	1.06
CTC-1378101	1	0.85
CTC-1400226	1	8.89
CTC-1400240	1	4.53
CTC-1407663	2	8.82
CTC-1410749	2	3.89
CTC-1411774	5	3.42
CTC-1434637	5	3.73
CTC-1447338	2	2.30
CTC-1490231	10	1.00
CTC-1522939	10	1.77
CTC-1531157	2	4.99
CTC-1534906	10	1.11
CTC-1534907	15	0.75
CTC-1548741	1	19.71
CTC-1565198	1	19.26
CTC-1598802	1	55.78
CTC-1614102	1	3.16
CTC-1616149	50	0.11
CTC-1618068	1	10.29
CTC-1618069	1	10.96
CTC-1629997	1	2.95
CTC-1654852	1	26.50
CTC-1654854	3	1.68
CTC-1658066	5	1.84
CTC-1659448	10	1.26
CTC-1697442	1	6.54
CTC-1704821	1	8.16
CTC-1704823	1	13.30
CTC-1704824	1	26.22
CTC-1704825	1	8.30
CTC-1705715	2	5.86
CTC-1705941	1	20.49
CTC-1707098	1	5.93
CTC-1707106	1	16.30
CTC-1738277	5	1.45
CTC-1753135	15	0.64
CTC-1755077	1	12.04
CTC-1757894	20	0.45

## O-RINGS

Part Number	Min. Pkgs.	List Price
CTC-1757895	20	\$ 0.51
CTC-1757896	20	0.57
CTC-1757897	20	0.60
CTC-1757898	20	0.67
CTC-1757900	20	0.70
CTC-1757902	10	0.95
CTC-1757903	5	2.21
CTC-1757904	10	1.21
CTC-1757905	10	1.25
CTC-1761378	1	8.86
CTC-1776911	1	34.16
CTC-1799013	10	1.55
CTC-1802391	1	9.19
CTC-1808424	6	0.91
CTC-1808722	50	0.33
CTC-1871979	15	1.00
CTC-1878567	10	1.08
CTC-1882199	1	1.87
CTC-1903010	5	2.95
CTC-1903011	5	2.10
CTC-1931736	1	10.46
CTC-1949584	2	3.51
CTC-1H0474	10	1.02
CTC-1H1023	50	0.06
CTC-1H5728	20	0.48
CTC-1H6227	10	0.76
CTC-1H7339	20	0.57
CTC-1H8128	20	0.69
CTC-1H8171	50	0.12
CTC-1H8278	5	2.54
CTC-1H8720	20	0.45
CTC-1H9696	20	0.52
CTC-1J2176	5	2.59
CTC-1J2859	10	1.25
CTC-1J2890	1	3.92
CTC-1J9671	50	0.21
CTC-1M0556	5	3.51
CTC-1M1077	50	0.12
CTC-1M3548	5	3.15
CTC-1M9015	1	3.92

## O-RINGS

Part Number	Min. Pkgs.	List Price
CTC-1R5318	20	\$ 0.40
CTC-1S7408	10	1.25
CTC-1S8947	50	0.09
CTC-1T0132	1	3.16
CTC-1U3174	1	3.47
CTC-2167244	1	0.10
CTC-2332597	10	1.00
CTC-2332601	10	1.26
CTC-2332603	5	1.76
CTC-2434572	1	8.23
CTC-2639891	50	0.11
CTC-2667959	2	7.07
CTC-2667960	2	8.82
CTC-2667961	2	9.32
CTC-2667962	1	12.94
CTC-2667966	5	2.64
CTC-2667967	5	2.91
CTC-2667968	2	3.43
CTC-2667969	2	3.52
CTC-2668026	5	2.93
CTC-2742500	5	2.64
CTC-2742501	2	6.92
CTC-2A3676	5	3.74
CTC-2D0598	20	0.26
CTC-2D1692	1	2.84
CTC-2D6533	1	4.10
CTC-2D8009	5	1.52
CTC-2D8363	1	12.64
CTC-2D8364	1	9.48
CTC-2D9572	1	3.16
CTC-2H2665	20	0.69
CTC-2H3927	20	0.31
CTC-2H3928	10	0.85
CTC-2H3931	20	0.63
CTC-2H3932	50	0.18
CTC-2H3933	20	0.70
CTC-2H3934	20	0.70
CTC-2H3935	10	1.33
CTC-2H4145	20	0.67
CTC-2H6124	5	2.65



# REPLACEMENT PARTS FOR CATERPILLAR® EQUIPMENT

**NOTE:** CATERPILLAR® part numbers are used as a reference only. We do not imply that these kits are original REPLACEMENT PARTS.

O-RINGS			O-RINGS			O-RINGS		
Part Number	Min. Pkgs.	List Price	Part Number	Min. Pkgs.	List Price	Part Number	Min. Pkgs.	List Price
CTC-2H6184	20	\$ 0.60	CTC-3E4297	1	\$ 10.38	CTC-3P0653	1	\$ 8.80
CTC-2H6338	20	0.63	CTC-3E4298	50	0.21	CTC-3P0654	1	11.76
CTC-2H6340	1	4.93	CTC-3E4299	20	0.61	CTC-3P0655	1	9.44
CTC-2H9247	10	1.25	CTC-3E6703	10	1.80	CTC-3P0656	1	8.33
CTC-2J8163	10	1.11	CTC-3E6730	20	0.89	CTC-3P0657	1	7.95
CTC-2K2939	5	2.09	CTC-3E6732	10	1.15	CTC-3P0658	1	39.97
CTC-2K4472	5	1.89	CTC-3E6735	10	1.36	CTC-3P1155	5	1.50
CTC-2K8198	50	0.18	CTC-3E6747	5	1.31	CTC-3S1223	5	2.09
CTC-2K8257	5	1.63	CTC-3E6749	5	1.42	CTC-3S6538	20	0.31
CTC-2M0340	1	2.90	CTC-3E6751	1	24.01	CTC-3S9233	50	0.12
CTC-2M1309	1	5.50	CTC-3E6760	50	0.10	CTC-3T7528	100	0.09
CTC-2M3340	1	7.58	CTC-3E6761	25	0.32	CTC-4D1577	1	7.27
CTC-2M4453	50	0.09	CTC-3E6766	2	3.70	CTC-4D2297	50	0.07
CTC-2M9780	50	0.25	CTC-3E6771	20	0.48	CTC-4D3107	20	0.22
CTC-2N3350	3	3.11	CTC-3E6773	2	5.97	CTC-4D4503	1	5.36
CTC-2P1692	5	1.25	CTC-3E6785	1	7.04	CTC-4D4508	1	6.01
CTC-2R0039	10	1.18	CTC-3E6788	5	1.68	CTC-4D6695	1	5.05
CTC-2S4078	20	0.51	CTC-3E6790	4	1.73	CTC-4F4097	20	0.63
CTC-2S8439	5	1.52	CTC-3E6799	2	6.21	CTC-4F5607	20	0.28
CTC-2T2691	20	0.76	CTC-3F1547	5	2.65	CTC-4F7387	10	1.25
CTC-2T2692	15	0.64	CTC-3F5792	10	1.25	CTC-4F7388	1	3.73
CTC-2T2695	5	2.22	CTC-3G1209	50	0.10	CTC-4F7389	20	0.31
CTC-2U5338	100	0.11	CTC-3H0107	50	0.12	CTC-4F7390	20	0.54
CTC-2U5341	5	1.73	CTC-3H0442	50	0.03	CTC-4F7391	50	0.19
CTC-2U5343	5	2.02	CTC-3H1461	20	0.21	CTC-4F7507	5	2.06
CTC-2Y2271	50	0.10	CTC-3H2652	20	0.57	CTC-4F7952	20	0.25
CTC-2Y2272	50	0.10	CTC-3H3385	50	0.09	CTC-4F8824	20	0.41
CTC-2Y2347	50	0.28	CTC-3H4970	50	0.18	CTC-4F8946	50	0.18
CTC-3202510	1	50.22	CTC-3J0634	5	2.33	CTC-4F9029	50	0.19
CTC-328970	15	0.49	CTC-3J1907	50	0.21	CTC-4F9653	20	0.45
CTC-3A9280	10	3.09	CTC-3J7354	50	0.21	CTC-4H6520	5	2.28
CTC-3B8453	50	0.21	CTC-3J9015	20	0.22	CTC-4H6730	1	11.05
CTC-3C5546	10	1.33	CTC-3K0360	50	0.24	CTC-4H9105	10	0.95
CTC-3D2824	50	0.31	CTC-3K0715	10	0.82	CTC-4J0519	20	0.40
CTC-3D2898	20	0.28	CTC-3K4025	20	0.46	CTC-4J0520	20	0.42
CTC-3D2992	50	0.12	CTC-3P0439	20	0.85	CTC-4J0521	20	0.45
CTC-3D4245	50	0.10	CTC-3P0648	2	3.59	CTC-4J0522	20	0.51
CTC-3D7805	20	0.35	CTC-3P0649	1	6.75	CTC-4J0523	20	0.62
CTC-3D8241	1	12.65	CTC-3P0650	1	6.08	CTC-4J0524	20	0.64
CTC-3E4296	10	0.94	CTC-3P0651	1	7.62	CTC-4J0525	20	0.66

CATERPILLAR®





# REPLACEMENT PARTS FOR CATERPILLAR® EQUIPMENT

**NOTE:** CATERPILLAR® part numbers are used as a reference only. We do not imply that these kits are original REPLACEMENT ARTS.

CATERPILLAR®

## O-RINGS

Part Number	Min. Pkgs.	List Price
CTC-4J0526	20	\$ 0.74
CTC-4J0527	20	0.77
CTC-4J0528	20	0.80
CTC-4J0537	20	0.77
CTC-4J1253	1	7.58
CTC-4J4577	50	0.10
CTC-4J5140	50	0.26
CTC-4J5267	50	0.29
CTC-4J5268	50	0.14
CTC-4J5351	50	0.14
CTC-4J5477	50	0.10
CTC-4J5573	20	0.59
CTC-4J5733	50	0.15
CTC-4J7533	50	0.15
CTC-4J8996	50	0.28
CTC-4J8997	50	0.33
CTC-4J8998	20	0.45
CTC-4K1388	20	0.37
CTC-4K2039	50	0.06
CTC-4K4986	50	0.26
CTC-4K6804	1	2.90
CTC-4L7711	20	0.26
CTC-4L9564	10	0.95
CTC-4M0189	10	0.82
CTC-4M0661	1	5.69
CTC-4M0737	1	7.47
CTC-4N1230	1	3.28
CTC-4S5879	1	6.20
CTC-4S7762	1	5.76
CTC-4T4128	1	7.58
CTC-4W2754	1	3.10
CTC-4W4616	1	1.73
CTC-5D1071	1	7.58
CTC-5D1597	10	1.68
CTC-5D5957	1	6.75
CTC-5D5959	1	28.32
CTC-5D6428	1	12.93
CTC-5D6539	50	0.18
CTC-5D6543	20	0.18
CTC-5E8767	5	1.34

## O-RINGS

Part Number	Min. Pkgs.	List Price
CTC-5E8768	5	\$ 1.58
CTC-5E8769	3	3.61
CTC-5E8770	2	3.34
CTC-5E9816	15	0.77
CTC-5F0149	10	1.11
CTC-5F1678	50	0.16
CTC-5F3092	10	0.82
CTC-5F3106	10	1.21
CTC-5F3144	10	1.14
CTC-5F3999	10	1.21
CTC-5F6222	1	3.28
CTC-5F7054	50	0.10
CTC-5F8000	20	0.38
CTC-5F9144	50	0.06
CTC-5F9657	20	0.22
CTC-5H2767	50	0.12
CTC-5H2824	5	3.58
CTC-5H3252	5	1.58
CTC-5H4909	1	3.16
CTC-5H5672	10	1.39
CTC-5H6005	50	0.07
CTC-5H6733	5	2.06
CTC-5H6734	10	1.08
CTC-5H7370	20	0.28
CTC-5H8038	50	0.21
CTC-5H8624	10	1.14
CTC-5H8848	20	0.51
CTC-5H9524	5	2.03
CTC-5J2383	1	5.12
CTC-5J2974	50	0.14
CTC-5J3886	5	1.39
CTC-5K0216	20	0.48
CTC-5K0227	20	0.45
CTC-5K1787	5	2.65
CTC-5K5221	20	0.29
CTC-5K5959	20	0.48
CTC-5K6526	20	0.35
CTC-5K9090	50	0.25
CTC-5L2727	20	0.31
CTC-5L4758	50	0.07

## O-RINGS

Part Number	Min. Pkgs.	List Price
CTC-5L4759	50	\$ 0.10
CTC-5L5032	5	2.54
CTC-5M2057	20	0.19
CTC-5M5860	20	0.28
CTC-5M6200	1	8.85
CTC-5M6509	20	0.45
CTC-5M7142	5	2.65
CTC-5M7423	20	0.28
CTC-5P0840	8	0.89
CTC-5P0908	20	0.46
CTC-5P1480	2	4.77
CTC-5P1979	5	1.89
CTC-5P2235	1	3.92
CTC-5P2236	1	9.07
CTC-5P2545	1	3.79
CTC-5P2568	20	0.26
CTC-5P2569	10	1.08
CTC-5P2931	20	0.60
CTC-5P3108	50	0.21
CTC-5P3620	5	2.20
CTC-5P3863	20	0.60
CTC-5P3864	5	1.70
CTC-5P3881	20	0.63
CTC-5P3944	50	0.12
CTC-5P4268	3	2.05
CTC-5P4326	5	1.46
CTC-5P4342	1	4.74
CTC-5P4889	2	4.77
CTC-5P4892	2	3.73
CTC-5P4933	50	0.11
CTC-5P5397	5	1.95
CTC-5P5598	7	0.96
CTC-5P5600	15	0.78
CTC-5P5601	10	0.87
CTC-5P5756	3	7.44
CTC-5P5757	2	2.56
CTC-5P5846	1	4.85
CTC-5P5874	50	0.11
CTC-5P6300	50	0.21
CTC-5P6302	10	1.36



# REPLACEMENT PARTS FOR CATERPILLAR® EQUIPMENT

**NOTE:** CATERPILLAR® part numbers are used as a reference only. We do not imply that these kits are original REPLACEMENT PARTS.

O-RINGS			O-RINGS			O-RINGS		
Part Number	Min. Pkgs.	List Price	Part Number	Min. Pkgs.	List Price	Part Number	Min. Pkgs.	List Price
CTC-5P6718	5	\$ 1.08	CTC-6F5559	50	\$ 0.07	CTC-6V3834	5	\$ 4.05
CTC-5P7530	10	1.18	CTC-6F6673	50	0.19	CTC-6V3835	1	20.21
CTC-5P7593	1	4.34	CTC-6F8146	20	0.63	CTC-6V3865	3	2.67
CTC-5P7701	4	3.11	CTC-6H3977	20	0.54	CTC-6V3907	1	14.05
CTC-5P7818	1	12.47	CTC-6H4162	1	4.43	CTC-6V3908	1	13.43
CTC-5P8065	5	1.42	CTC-6H5672	50	0.22	CTC-6V3922	50	0.15
CTC-5P8066	1	1.93	CTC-6H9691	50	0.03	CTC-6V3955	3	2.97
CTC-5P8068	2	4.58	CTC-6J1038	50	0.25	CTC-6V3967	1	60.92
CTC-5P8118	4	1.59	CTC-6J2245	10	0.74	CTC-6V3968	1	29.52
CTC-5P8210	3	1.82	CTC-6J2419	20	0.21	CTC-6V4297	1	25.99
CTC-5P8211	3	3.20	CTC-6J2680	10	0.99	CTC-6V4314	1	16.70
CTC-5P8215	20	0.22	CTC-6J5541	5	3.18	CTC-6V4315	1	12.71
CTC-5P8286	1	8.80	CTC-6K6307	10	0.74	CTC-6V4366	15	0.80
CTC-5P8428	1	12.06	CTC-6K9149	5	3.80	CTC-6V4367	5	1.38
CTC-5P8429	1	34.65	CTC-6M5062	50	0.06	CTC-6V4430	2	3.39
CTC-5P8861	1	28.27	CTC-6R0365	10	1.25	CTC-6V4480	2	3.39
CTC-5P8862	1	27.17	CTC-6V0357	50	0.35	CTC-6V4589	8	1.41
CTC-5P8872	1	14.89	CTC-6V0894	50	0.16	CTC-6V5049	14	0.77
CTC-5P8883	3	1.68	CTC-6V0895	20	0.35	CTC-6V5050	5	2.29
CTC-5P8940	1	15.94	CTC-6V0913	50	0.14	CTC-6V5051	1	9.97
CTC-5P8942	1	0.37	CTC-6V0973	1	12.06	CTC-6V5052	1	14.05
CTC-5P9186	1	0.83	CTC-6V1175	1	7.58	CTC-6V5053	1	7.16
CTC-5P9217	1	7.58	CTC-6V1195	1	9.53	CTC-6V5054	1	19.50
CTC-5P9658	10	0.98	CTC-6V1196	2	5.20	CTC-6V5055	1	24.84
CTC-5P9757	15	0.46	CTC-6V1197	1	6.30	CTC-6V5057	1	53.06
CTC-5P9890	2	3.34	CTC-6V1320	2	3.94	CTC-6V5060	1	68.06
CTC-5P9939	20	0.38	CTC-6V1902	1	12.76	CTC-6V5095	1	32.58
CTC-5S0982	5	3.85	CTC-6V1934	1	6.65	CTC-6V5101	1	14.11
CTC-5S3676	1	3.16	CTC-6V3251	15	0.85	CTC-6V5102	1	29.72
CTC-5S6760	1	22.53	CTC-6V3263	1	9.66	CTC-6V5103	1	23.02
CTC-5S9134	1	13.14	CTC-6V3319	1	11.49	CTC-6V5134	2	3.63
CTC-5W9413	10	1.20	CTC-6V3348	3	3.18	CTC-6V5142	15	0.77
CTC-6D7128	12	0.67	CTC-6V3349	1	33.26	CTC-6V5143	5	1.59
CTC-6D7146	2	4.61	CTC-6V3551	1	11.63	CTC-6V5167	1	25.07
CTC-6D7889	2	2.47	CTC-6V3684	1	20.72	CTC-6V5266	3	2.12
CTC-6D9157	5	2.09	CTC-6V3685	40	0.35	CTC-6V5375	1	38.21
CTC-6F0671	5	3.28	CTC-6V3830	1	4.26	CTC-6V5393	20	0.33
CTC-6F0711	20	0.28	CTC-6V3831	1	6.61	CTC-6V5553	1	11.29
CTC-6F4718	5	1.89	CTC-6V3832	2	2.23	CTC-6V5556	50	0.25
CTC-6F4855	50	0.07	CTC-6V3833	1	10.50	CTC-6V5586	50	0.10

CATERPILLAR®



# REPLACEMENT PARTS FOR CATERPILLAR® EQUIPMENT

**NOTE:** CATERPILLAR® part numbers are used as a reference only. We do not imply that these kits are original REPLACEMENT PARTS.

CATERPILLAR®

## O-RINGS

Part Number	Min. Pkgs.	List Price
CTC-6V5656	1	\$ 11.22
CTC-6V5657	5	2.20
CTC-6V5722	50	0.10
CTC-6V5758	10	0.85
CTC-6V5759	8	0.87
CTC-6V5862	1	7.58
CTC-6V6228	10	1.08
CTC-6V6339	50	2.93
CTC-6V6353	1	6.37
CTC-6V6580	50	0.21
CTC-6V6638	1	63.24
CTC-6V6707	10	1.18
CTC-6V6756	3	3.20
CTC-6V7350	1	5.64
CTC-6V7351	1	9.37
CTC-6V7610	5	1.77
CTC-6V7658	1	1.77
CTC-6V7681	1	11.69
CTC-6V7701	1	40.72
CTC-6V8001	2	5.41
CTC-6V8002	2	5.64
CTC-6V8218	50	0.29
CTC-6V8260	1	7.95
CTC-6V8350	15	0.91
CTC-6V8397	50	0.10
CTC-6V8398	50	0.11
CTC-6V8399	50	0.15
CTC-6V8400	50	0.28
CTC-6V8467	5	1.99
CTC-6V8676	3	1.89
CTC-6V8958	2	7.40
CTC-6V8978	50	0.28
CTC-6V9746	50	0.15
CTC-7D1195	5	3.30
CTC-7D7111	1	14.46
CTC-7D9014	5	3.69
CTC-7E4846	50	0.26
CTC-7E4847	20	0.33
CTC-7F2122	10	0.76
CTC-7F8267	20	0.31

## O-RINGS

Part Number	Min. Pkgs.	List Price
CTC-7F8268	20	\$ 0.38
CTC-7H2444	10	0.85
CTC-7H9959	5	3.00
CTC-7J0204	50	0.15
CTC-7J2036	20	0.41
CTC-7J6285	10	1.16
CTC-7J8956	5	2.28
CTC-7J9108	50	0.14
CTC-7L4090	10	1.25
CTC-7L4774	5	1.36
CTC-7L9061	10	0.78
CTC-7M8485	20	0.41
CTC-7R8872	20	0.51
CTC-7S4001	10	0.99
CTC-7S8554	1	5.69
CTC-7S8561	1	7.90
CTC-7U3263	2	9.48
CTC-7U7852	1	25.16
CTC-7X1547	1	15.31
CTC-7X1550	50	0.33
CTC-7X4744	10	1.25
CTC-7X4745	3	2.05
CTC-7X4782	10	1.11
CTC-7X4805	10	0.87
CTC-7X4810	1	35.45
CTC-7X5494	10	0.76
CTC-7X8592	5	1.59
CTC-7X9372	10	0.74
CTC-7Y4277	1	5.52
CTC-7Y4294	1	6.23
CTC-7Y5219	50	0.14
CTC-7Y5269	20	0.66
CTC-7Y5280	100	0.08
CTC-8B4967	50	0.22
CTC-8B7216	50	0.06
CTC-8C0563	20	0.68
CTC-8C0624	5	1.50
CTC-8C3057	5	2.24
CTC-8C3058	5	5.58
CTC-8C3059	2	13.98

## O-RINGS

Part Number	Min. Pkgs.	List Price
CTC-8C3077	2	\$ 5.94
CTC-8C3079	3	2.03
CTC-8C3080	20	0.29
CTC-8C3081	20	0.45
CTC-8C3085	50	0.10
CTC-8C3086	50	0.14
CTC-8C3087	50	0.15
CTC-8C3088	50	0.25
CTC-8C3089	2	3.70
CTC-8C3093	15	0.85
CTC-8C3095	9	0.35
CTC-8C3097	20	0.53
CTC-8C3098	50	0.10
CTC-8C3101	5	2.59
CTC-8C3102	5	2.59
CTC-8C3103	1	15.27
CTC-8C3107	1	5.32
CTC-8C3131	20	0.52
CTC-8C3828	1	60.50
CTC-8C5197	2	3.05
CTC-8C5230	1	4.99
CTC-8C5237	1	1.08
CTC-8F4469	5	1.78
CTC-8F4994	50	0.22
CTC-8F5900	1	3.16
CTC-8F6230	1	3.16
CTC-8F6498	1	4.93
CTC-8F6711	20	0.41
CTC-8F7219	50	0.03
CTC-8F8230	1	3.16
CTC-8F8733	5	1.70
CTC-8F8861	1	4.74
CTC-8F8882	20	0.51
CTC-8F9206	50	0.07
CTC-8F9516	5	1.46
CTC-8F9538	50	0.03
CTC-8F9960	1	7.84
CTC-8H0273	5	2.39
CTC-8H2046	10	1.02
CTC-8H7521	20	0.67



# REPLACEMENT PARTS FOR CATERPILLAR® EQUIPMENT

**NOTE:** CATERPILLAR® part numbers are used as a reference only. We do not imply that these kits are original REPLACEMENT ARTS.

## O-RINGS

Part Number	Min. Pkgs.	List Price
CTC-8H8257	1	\$ 5.36
CTC-8J1665	5	2.43
CTC-8J1688	5	1.70
CTC-8J2413	50	0.21
CTC-8J4351	3	2.63
CTC-8J4386	1	5.34
CTC-8J8343	50	0.12
CTC-8J8725	2	3.51
CTC-8J8879	1	3.47
CTC-8L2746	1	0.46
CTC-8L2777	15	0.55
CTC-8L2779	1	0.37
CTC-8L9241	1	3.98
CTC-8M8997	50	0.09
CTC-8P6357	1	16.41
CTC-8S5011	2	2.65
CTC-8S5953	20	0.66
CTC-8T0116	100	0.11
CTC-8T0135	20	0.35
CTC-8T0315	20	0.35
CTC-8T2148	20	2.02
CTC-8T2360	3	2.89
CTC-8T2361	3	2.92
CTC-8T2944	2	4.07
CTC-8T3013	1	18.31
CTC-8T3338	5	6.11
CTC-8T4811	1	7.58
CTC-8T4827	50	0.29
CTC-8T4945	1	0.90
CTC-8T5049	10	1.61
CTC-8T5376	5	1.72
CTC-8T5452	10	1.25
CTC-8T6346	5	2.41
CTC-8T6404	5	1.89
CTC-8T6444	5	2.33
CTC-8T6447	50	0.09
CTC-8T6716	5	2.10
CTC-8T6717	3	3.38
CTC-8T7568	5	2.65
CTC-8T9522	5	1.47

## O-RINGS

Part Number	Min. Pkgs.	List Price
CTC-8T9527	1	\$ 7.16
CTC-8T9529	15	0.85
CTC-8U1958	2	10.72
CTC-8U4125	1	2.60
CTC-8U5927	2	4.01
CTC-8U5942	1	0.57
CTC-9C3493	1	5.52
CTC-9F1399	5	2.03
CTC-9F4446	10	0.85
CTC-9F7283	10	1.25
CTC-9H0846	1	11.05
CTC-9H4557	50	0.22
CTC-9J5686	20	0.82
CTC-9J6491	50	0.14
CTC-9M2092	10	1.14
CTC-9M3786	5	1.95
CTC-9M5024	5	2.65
CTC-9M5894	1	2.95
CTC-9N1756	1	0.35
CTC-9S3888	5	1.58
CTC-9S8307	20	0.74
CTC-9T4057	50	0.21
CTC-9W3340	25	0.41
CTC-9X3979	10	1.25
CTC-9X4576	1	9.57
CTC-9X4611	10	1.40
CTC-9X4617	10	1.03
CTC-9X4626	10	0.84
CTC-9X7286	1	10.13
CTC-9X7287	1	7.48
CTC-9X7295	1	12.76
CTC-9X7357	10	1.77
CTC-9X7358	5	3.03
CTC-9X7371	1	8.42
CTC-9X7375	5	1.89
CTC-9X7377	10	0.92
CTC-9X7380	30	0.07
CTC-9X7383	15	0.13
CTC-9X7422	1	6.54
CTC-9X7430	10	2.48

## O-RINGS

Part Number	Min. Pkgs.	List Price
CTC-9X7432	1	\$ 1.68
CTC-9X7440	5	2.58
CTC-9X7454	50	0.15
CTC-9X7458	5	2.06
CTC-9X7557	2	5.86
CTC-9X7562	1	18.79
CTC-9X7566	5	2.20
CTC-9X7676	15	0.46
CTC-9X7680	15	0.71
CTC-9X7681	15	0.77
CTC-9X7683	1	2.20
CTC-9X7684	20	0.25
CTC-9X7688	0	57.51
CTC-9X7692	50	0.27
CTC-9X7712	3	3.16
CTC-9X7725	5	2.14
CTC-9X7734	8	0.78
CTC-9X7745	50	0.24
CTC-Z440101000	2	5.10
CTC-Z440101100	2	6.63
CTC-Z440201000	2	6.40
CTC-Z440201400	2	7.07
CTC-Z441001000	1	1.99
CTC-Z441001100	5	8.63
CTC-Z441100950	1	2.30
CTC-Z441101050	5	2.56
CTC-Z441101150	5	2.64
CTC-Z441101600	2	9.32

## SWIVEL SEALS

Part Number	List Price
CTC-1597782	\$ 36.41

CATERPILLAR®



# REPLACEMENT PARTS FOR CATERPILLAR® EQUIPMENT

**NOTE:** CATERPILLAR® part numbers are used as a reference only. We do not imply that these kits are original REPLACEMENT PARTS.

## BACK-UP RINGS

Part Number	Min. Pkgs.	List Price
CTC-0306141	5	\$ 2.83
CTC-0875391	1	15.64
CTC-0875397	1	62.62
CTC-0875436	1	12.15
CTC-0875510	1	11.67
CTC-0875550	1	13.92
CTC-0931512	1	5.92
CTC-0931513	1	7.73
CTC-0931514	1	11.89
CTC-0931515	1	13.13
CTC-0931518	1	22.21
CTC-0931519	1	24.94
CTC-0951783	1	2.38
CTC-0951789	1	2.38
CTC-0951796	1	6.70
CTC-0961054	1	46.53
CTC-0961055	1	9.24
CTC-0961566	1	11.67
CTC-0961568	1	11.15
CTC-0961588	1	11.15
CTC-0962665	1	12.98
CTC-0963467	1	23.22
CTC-0963964	1	11.67
CTC-0964276	1	2.63
CTC-0990173	1	3.41
CTC-0990660	1	9.44
CTC-0990681	1	10.46
CTC-0990699	1	15.94
CTC-0993204	1	11.15
CTC-0995399	1	10.91
CTC-0996974	1	7.92
CTC-0996999	1	35.25
CTC-0997000	1	10.80
CTC-1011983	1	2.45
CTC-1052578	1	11.15
CTC-1052579	1	11.82
CTC-1052583	1	11.99
CTC-1057360	1	11.45
CTC-1057375	1	11.67
CTC-1057393	1	9.20

## BACK-UP RINGS

Part Number	Min. Pkgs.	List Price
CTC-1076255	1	\$ 12.98
CTC-1076258	1	8.95
CTC-1076262	1	14.17
CTC-1079308	1	9.37
CTC-1140706	1	14.07
CTC-1140711	1	15.25
CTC-1211372	1	12.98
CTC-1214160	1	10.03
CTC-1220440	1	11.91
CTC-1238614	1	14.59
CTC-1259695	1	17.11
CTC-1261978	1	16.87
CTC-1336716	1	11.20
CTC-1373660	1	54.24
CTC-1400233	3	3.25
CTC-1407652	1	12.15
CTC-1475771	1	44.16
CTC-1505827	1	57.26
CTC-1505842	1	11.45
CTC-1505844	1	9.81
CTC-1540731	1	11.15
CTC-1540738	1	12.98
CTC-1540751	1	11.15
CTC-1540769	1	36.53
CTC-1559193	1	39.61
CTC-1577244	1	56.74
CTC-1577245	1	56.37
CTC-1583026	1	6.05
CTC-1583027	1	20.80
CTC-1583031	1	4.43
CTC-1583032	1	70.08
CTC-1607550	1	0.81
CTC-1627209	1	4.08
CTC-1663002	1	11.99
CTC-1682271	5	1.77
CTC-1704746	1	25.33
CTC-1704748	1	45.56
CTC-1704749	1	24.01
CTC-1843478	1	2.26
CTC-1890215	2	5.96

## BACK-UP RINGS

Part Number	Min. Pkgs.	List Price
CTC-1915647	1	\$ 36.78
CTC-1922056	1	55.09
CTC-1922057	1	123.23
CTC-1948355	1	12.98
CTC-1948365	1	12.98
CTC-1980661	1	27.55
CTC-1982640	1	15.38
CTC-1982643	1	13.20
CTC-1982644	1	9.37
CTC-1K7095	4	2.18
CTC-1K7098	5	1.77
CTC-1S0668	6	1.23
CTC-1S0669	5	1.43
CTC-1S0670	8	0.93
CTC-1U1101	2	6.52
CTC-1U1626	1	5.71
CTC-1U1738	2	4.35
CTC-1U1770	2	4.89
CTC-1U3173	2	4.71
CTC-1U3307	2	4.89
CTC-2020970	1	36.13
CTC-2151942	3	2.13
CTC-2159864	1	47.46
CTC-2199051	1	11.67
CTC-2332599	10	1.25
CTC-2344487	1	11.93
CTC-2344581	1	11.98
CTC-2344584	1	13.07
CTC-2376124	1	10.65
CTC-2377078	1	5.86
CTC-2378378	1	10.80
CTC-2443838	6	1.22
CTC-2448826	5	1.74
CTC-2462899	1	26.24
CTC-2508718	1	7.92
CTC-2590654	1	11.15
CTC-2593174	1	4.18
CTC-2639883	1	10.80
CTC-2725643	1	35.25
CTC-2725680	1	30.44

CATERPILLAR®



# REPLACEMENT PARTS FOR CATERPILLAR® EQUIPMENT

**NOTE:** CATERPILLAR® part numbers are used as a reference only. We do not imply that these kits are original REPLACEMENT PARTS.

## BACK-UP RINGS

Part Number	Min. Pkgs.	List Price
CTC-2773386	1	\$ 10.91
CTC-2774933	1	10.91
CTC-2788633	1	10.65
CTC-2J0744	2	6.42
CTC-2J3961	3	2.48
CTC-2J4066	5	1.43
CTC-2J7767	3	2.86
CTC-2K2940	2	4.69
CTC-2K2961	3	3.25
CTC-2K3258	2	3.89
CTC-2K4096	3	2.63
CTC-2K4473	2	4.22
CTC-2K6830	5	1.77
CTC-2K8256	2	4.11
CTC-2Y8973	6	1.44
CTC-3C3239	10	0.99
CTC-3E6795	1	19.53
CTC-3G3747	2	4.84
CTC-3J2688	1	7.02
CTC-3J8466	1	6.87
CTC-3J9742	2	5.24
CTC-3K7219	9	0.86
CTC-3K7863	9	0.81
CTC-3K8692	9	0.86
CTC-3K8699	10	0.90
CTC-3P1204	8	0.93
CTC-3P1205	8	0.86
CTC-3P1206	5	1.65
CTC-3P1207	7	1.12
CTC-4I3615	1	10.89
CTC-4I3627	1	12.51
CTC-4I3631	1	14.17
CTC-4I6330	1	17.63
CTC-4I6442	1	19.39
CTC-4J1151	1	7.21
CTC-4J6557	2	6.52
CTC-4J9218	2	4.60
CTC-4J9219	5	1.44
CTC-4J9220	5	1.77
CTC-4J9221	4	2.43

## BACK-UP RINGS

Part Number	Min. Pkgs.	List Price
CTC-4J9223	2	\$ 4.22
CTC-4J9224	6	1.23
CTC-4J9225	7	1.12
CTC-4K4759	9	0.81
CTC-4T3107	2	4.90
CTC-4T5072	4	2.73
CTC-4T5929	1	18.01
CTC-5J0604	2	3.72
CTC-5J0605	10	0.99
CTC-5J3934	5	1.74
CTC-5J6444	2	5.81
CTC-5J7865	5	1.77
CTC-5K7865	5	1.77
CTC-5P0909	3	3.25
CTC-5P0910	4	2.26
CTC-5P0911	6	1.35
CTC-5P2134	8	0.99
CTC-5P2199	10	0.90
CTC-5P3235	2	4.90
CTC-5P7857	9	0.81
CTC-5P7858	9	0.81
CTC-5P8208	10	0.90
CTC-5P8921	4	2.40
CTC-5P9685	8	0.90
CTC-5P9686	8	0.99
CTC-5P9687	8	0.99
CTC-6J1021	10	0.99
CTC-6J1381	6	1.23
CTC-6J2418	8	0.99
CTC-6J2420	7	1.12
CTC-6J5731	7	1.12
CTC-6U3042	3	3.31
CTC-6U5640	3	2.15
CTC-6V1555	7	1.12
CTC-6V1556	8	0.93
CTC-6V1557	10	0.90
CTC-6V1558	7	1.12
CTC-6V1941	8	0.86
CTC-6V3299	8	0.99
CTC-6V3300	8	0.99
CTC-6V3580	1	8.73

## BACK-UP RINGS

Part Number	Min. Pkgs.	List Price
CTC-6V3838	9	\$ 0.81
CTC-6V3956	9	0.81
CTC-7J4823	1	6.51
CTC-7J6287	10	0.99
CTC-7J6288	8	0.90
CTC-7J8955	2	4.35
CTC-7X4757	2	4.89
CTC-7X4807	2	3.89
CTC-7Y4628	1	57.26
CTC-7Y4633	1	11.42
CTC-7Y4669	1	55.81
CTC-7Y4673	1	13.20
CTC-7Y4941	1	12.98
CTC-7Y4945	1	15.38
CTC-7Y5116	1	54.36
CTC-8J0548	2	4.35
CTC-8J1666	2	4.35
CTC-8J1689	3	3.07
CTC-8J1717	2	3.69
CTC-8J2574	6	1.23
CTC-8J3752	4	2.16
CTC-8J4385	2	4.35
CTC-8J8880	1	7.30
CTC-8Q5979	1	3.07
CTC-8T8434	1	3.60
CTC-9J0240	9	0.81
CTC-9J0705	10	0.76
CTC-9J7861	3	2.55
CTC-9T8761	5	2.45
CTC-9X4596	1	7.30
CTC-9X4615	1	7.71
CTC-9X7273	2	4.35
CTC-9X7278	4	2.40
CTC-9X7279	3	2.55
CTC-A04700312	1	9.44
CTC-A04700313	1	10.46
CTC-A04700414	1	40.03
CTC-A04700415	1	9.24
CTC-A04700416	1	9.24
CTC-A04700417	1	32.35
CTC-A04700712	1	9.44

CATERPILLAR®



# REPLACEMENT KITS FOR CATERPILLAR® EQUIPMENT

**NOTE:** CATERPILLAR® part numbers are used as a reference only. We do not imply that these kits are original REPLACEMENT PARTS.

## CAT D-RING KIT

This handy kit, in an unbreakable box, contains the 9 most popular sized D-Rings used on CATERPILLAR® equipment.

Part Number: CTC-4C4784  
List Price: \$ 154.76



## CAT SILICONE O-RING KIT

This handy kit, in an unbreakable box, contains 149 silicone o-rings in the 32 most popular sizes used on CATERPILLAR® equipment.

Part Number: CTC-4C8253  
List Price: \$ 416.89



## CAT NITRILE O-RING KIT

This handy kit, in an unbreakable box, contains 570 nitrile o-rings in the 32 most popular sizes used on CATERPILLAR® equipment.

Part Number: CTC-4C4782  
List Price: \$ 261.49



## CAT KIT FACE KIT

This handy kit contains a total of 120 90 Durometer O-Rings in 8 different sizes.

Part Number: CTC-4C5859  
List Price: \$ 77.04



## CAT FLANGE KIT

This handy kit contains the 6 most popular sized flange seals O-Rings used on CATERPILLAR® equipment.

Part Number: CTC-2701545  
List Price: \$ 40.18



CATERPILLAR®



# REPLACEMENT PARTS FOR CATERPILLAR® EQUIPMENT

**NOTE:** CATERPILLAR® part numbers are used as a reference only. We do not imply that these kits are original REPLACEMENT PARTS.

## “NYLON INSERT” LOCKING NUTS

Manufactured from the finest quality steel and heat treated to offer superior strength, MAXX® Hydraulics locking nuts with nylon inserts are specifically designed and manufactured to exact dimensions. The high temperature locking inserts are designed to withstand the high temperatures associated with close tolerance performance applications.

Part Number	Thread Size & Pitch	Height	Flats	List Price
CTC-2J0564	2 - 12	1-5/8	3-1/8	\$ 96.38
CTC-2J3247	1-3/4 - 12	1-7/16	2-3/4	66.86
CTC-2J3950	1-1/2 - 12	1-5/16	2-3/8	37.86
CTC-2J6384	1-1/4 - 12	1-1/8	2	33.74
CTC-2J7686	2-1/2 - 12	2-3/16	4	219.68
CTC-3J6899	2-1/4 - 12	2-13/16	3-1/2	221.36
CTC-3J9449	2-1/2 - 12	2-5/8	4	253.70
CTC-3J9545	2 - 12	2-7/16	3-1/8	157.77
CTC-4J6888	2-3/4 - 12	2-1/4	4	160.37
CTC-4J8734	2-3/4 - 12	3-1/8	4	306.62
CTC-5J3488	2-1/4 - 12	1-15/16	3-1/2	162.51
CTC-5J5731	1-3/4 - 12	1-7/16	2-1/2	45.22
CTC-7J9250	3-1/4 - 12	3-1/8	4-1/2	327.88
CTC-9X6018	4 - 12	3.73	5.62	688.21
CTC-1438149	M48 × 2	50 mm	75 mm	146.59
CTC-1438150	M56 × 2	56 mm	85 mm	154.05
CTC-1336686	M56 × 2	57 mm	80 mm	168.44
CTC-1475835	M64 × 2	63 mm	95 mm	207.07
CTC-7Y4622	M72 × 2	70 mm	105 mm	383.18
CTC-7Y4695	M80 × 2	76 mm	115 mm	366.51
CTC-1232060	M80 × 2	64 mm	115 mm	259.85
CTC-1232112	M90 × 2	76 mm	130 mm	459.92
CTC-7Y4956	M90 × 2	84 mm	130 mm	438.88
CTC-0875385	M95 × 2	88 mm	135 mm	546.59
CTC-1261971	M100 × 2	89 mm	146 mm	1048.80
CTC-1163513	M105 × 2	97 mm	150 mm	943.73
CTC-1163516	M120 × 2	108 mm	170 mm	1043.94

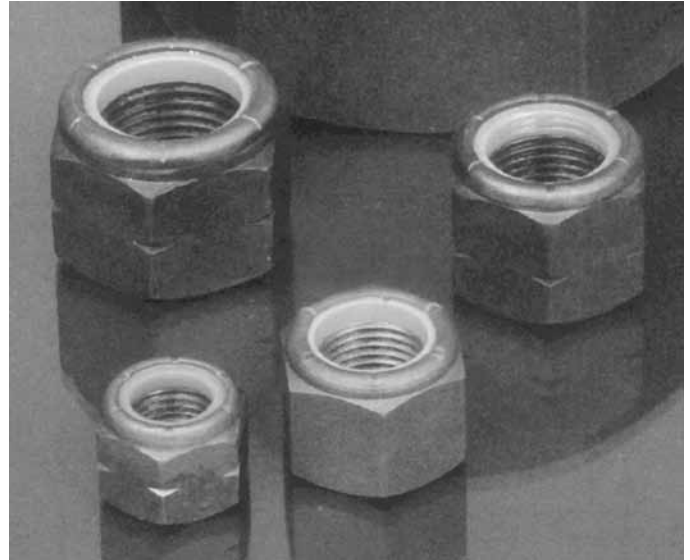

CATERPILLAR®



## REPLACEMENT KITS FOR CATERPILLAR® TOWMOTOR LIFT TRUCKS

**NOTE:** If you can locate the cylinder group number, it can aid in identifying the proper kit.

Kit Number	Code (Pg. xviii)	Rode X Bore Size	List Price	Kit Number	Code (Pg. xviii)	Rode X Bore Size	List Price
TM-1033947	I-U-10	40 X 90 mm	\$ 69.12	TM-396848	P-UB-11	1-1/4 X 3	\$ 40.17
TM-1040763	P-U-1	70 mm	54.32	TM-396849	I-V-8	2 X 5.025	63.61
TM-1040900	I-U-10	37 X 71 mm	37.25	TM-659060	O-RINGS		6.77
TM-1040948	P-U-1	35 mm	27.63	TM-690003	I-U-5	2 X 5	97.61
TM-1041095	P-U-1	40 x 50 mm	91.83	TM-691389	I-OB-3	1-1/2 X 2-1/2	21.04
TM-1042519	P-U-1	85 X 100 mm	64.33	TM-693683	O-RINGS		8.09
TM-1042609	P-U-4	45 X 55 mm	68.81	TM-694526	I-UB-5	2 X 5	93.54
TM-1146727	P-U-14	50 X 110 mm	100.32	TM-694527	I-UB-5	2-1/2 X 6	103.43
TM-206398	RETAINER RING		0.85	TM-694528	I-U-4, 10	2 X 4-1/2	63.49
TM-324908	I-V-8	2 X 4.525	60.38	TM-695522	I-UB-5	1-1/4 X 3-1/2	67.17
TM-375427	I-U-11	1 X 2-1/2	16.40	TM-695523	I-UB-5	1-1/2 X 4	80.18
TM-376968	I-U-1	2-1/2 Rod	32.09	TM-901523	I-U-1	2-1/2, 3-1/4, 4 Stages	146.77
TM-388594-6	P-UB-10	1-1/2 X 3-1/2	39.12	TM-905761	P-U-1	3-1/8, 4-3/8 Stages	191.11
TM-396743	I-P-N-8	3 X 4.025	86.63	TM-905771	P-U-1	2-3/8, 4-3/8 Stages	154.78
TM-396744	I-U-8	2-1/2 X 3.525	38.86	TM-905961	VALVE KIT		10.90
TM-396746	I-P-U-1	2-1/4, 3-1/4, 4-1/8 Stages	133.40	TM-905962	VALVE KIT		5.11
TM-396747	P-U-8	3 X 3.525	53.39	TM-906496	I-U-10	3 X 4	52.16
TM-396748	I-U-8	3 X 4.025	49.31	TM-911700	I-U-1	75 mm Rod Kit	43.57
TM-396749	P-U-1	3-1/8, 4-3/8, 5 Stages	226.74	TM-911701	I-U-N	50 mm Rod Kit	46.33
TM-396750	P-U-1	2-3/16 X 2-1/2	45.67	TM-911725	I-O-10	25 X 50 mm	46.14
TM-396751	P-U-8	3-3/4 X 5.025	82.11	TM-911726	I-U-10	35 X 80 mm	55.87
TM-396752	I-U-8	2-5/8 X 3.025	58.91	TM-911956	P-U-1	1-5/8 Rod Kit	22.27
TM-396754	I-U-8	2-1/2 X 3.025	38.69	TM-912067	P-UB-10	1-1/4 X 3	30.01
TM-396755	I-U-8	3 X 3.525	46.94	TM-912711	P-U-1	2-3/8 Rod Kit	34.61
TM-396756	I-P-1-8	3 X 4.025	71.44	TM-912748	P-U-1	2-3/8 Rod Kit	34.71
TM-396757	P-U-1	2-3/8, 4-3/8, 5 Stages	211.58	TM-914206	P-UB-10	2 X 4-1/2	63.20
TM-396758	I-P-U-1	1-7/8, 2-3/4, 3-5/8 Stages	115.65	TM-914634	I-U-N	3-3/4" Rod	38.16
TM-396759	I-V-1	2.700, 3.450, 5.700 Stgs.	145.00	TM-914635	I-U-10	2 X 2-1/2	66.11
TM-396760	I-V-1	2.200, 2.950, 4.700 Stgs.	112.77	TM-914636	N-U-10	4 X 4-1/2	99.17
TM-396761	I-P-N-8	3 X 5.025	98.63	TM-917170	U-SEAL	4-3/8	31.48
TM-396801	P-U-1	3-3/8, 4-3/8, 5 Stages	251.34	TM-917174	U-SEAL	2-1/4	8.50
TM-396842	P-UB-10	1-1/2 X 3-1/2	37.85	TM-917175	U-SEAL	3-1/4	11.76
TM-396843	P-U-11	1-1/2 X 3-1/2	28.83	TM-917177	U-SEAL	2-3/4	10.14
TM-396844	P-UB-11	1-1/2 X 3-1/2	30.22	TM-918024	P-U-4	150 X 180 mm	356.32
TM-396845	I-U-11	1-1/4 X 3	22.51	TM-919851	P-U-15	120 X 180 mm	631.12
TM-396846	P-UB-10	2 X 4-1/2	85.11	TM-920666	I-U-N	50 mm Rod Kit	37.90
TM-396847	I-V-8	2 X 4.525	55.39	TM-923282	I-U-10	2 X 2-1/2	104.74

CATERPILLAR®



## REPLACEMENT PARTS FOR CATERPILLAR® TOWMOTOR LIFT TRUCKS

Part Number	Type	O.D.	I.D.	Hgt.	List Price
TM-5461	Vee Set	1-1/4	1-3/4VS		\$ 10.48
TM-41248	Vee Set	2.200	2.700	1	18.04
TM-41250	Vee Set	2.950	3.450	1	20.56
TM-41252	Vee Set	4.700	5.290	1	35.17
TM-41340	Vee Set	4.025	5.025	1.3	42.49
TM-67841	Vee Set	2.700	3.450		23.49
TM-67842	Vee Set	3.450	4.250	1.5	42.47

Part Number	Type	O.D.	I.D.	Hgt.	List Price
TM-67843	Vee Set	5.700	6.450		\$ 46.35
TM-303231	Wiper	1	1-3/8	3/16	2.87
TM-303233	Wiper	2			3.32
TM-303260	Vee Set	2.275	3.025	1.2	19.35
TM-371212	Modular Back-up Ring	5	5-3/4	.226	32.61
TM-903016	Wiper	5	5-3/4	3/8	44.86

## CHAMPION MOTOR GRADER

Kit Number	Code ( P g . xviii)	Rode X Bore Size	List Price
CHMP-26408	1-3/8 X 3	I-U-5	\$ 45.94
CHMP-26409	2 X 4	I-U-5	66.26
CHMP-26410	2 X 5	I-U-5	89.61

CATERPILLAR® - CHAMPION

## CHAR-LYNN® SEAL KITS

### CHAR-LYNN® Model Identification

XXX - XXX - XXX  
Product - Product - Engineering  
Line Identification Change Code

Kit Number	Series	Description	Model Number	List Price
CHR-6405	10,000 Note: The -002 and -003 bearingless motors use 4 seals while the -004 motor uses 3 seals. Note: This kit is not applicable to 10,000 series two speed motors.	Motor Seal Kit	119-XXXX-002;-003;-004 120-XXXX-002;-003;-004  121-XXXX-002;-003;-004	\$ 106.08
CHR-6406	10,000 Note: Applicable to 10,000 series two speed motors.	Shaft Seal Kit	119-XXXX-001;-002;-003;-004 120-XXXX-002;-003;-004  121-XXXX-001;-002;-003;-004	114.19
CHR-60023	H	Buna N Seal Kit	101-XXXX-007	78.91
	A	Buna N Seal Kit	130-XXXX-001	
CHR-60026	S	Buna N Seal Kit	103-XXXX-007	81.35
CHR-60036	H	Buna N Seal Kit	101-XXXX-005	61.84
CHR-60042	S	Buna N Seal Kit	103-XXXX-006	81.79
CHR-60533	S	Buna N Seal Kit	103-XXXX-008	75.93
CHR-60539	S	Buna N Seal Kit	103-XXXX-009;-010	96.15
CHR-60540	A	Buna N Seal Kit	130-XXXX-002;-003	93.43
	H	Buna N Seal Kit	101-XXXX-008;-009	
CHR-61104	6000	Shaft Seal Kit	112-XXXX-002;-003;-004 113-XXXX-002;-003;-004	159.28
CHR-61105	6000	Rear Motor Kit	112-XXXX-002;-003;-004 113-XXXX-002;-003;-004	58.28
CHR-61234	4000	Rear Motor Kit	109-XXXX-004; 110-XXXX-004	54.12
CHR-61236	4000	Shaft Seal Kit	109-XXXX-004; 110-XXXX-004	85.33
CHR-61237	6000	Shaft Seal Kit	112-XXXX-005; 113-XXXX-005	86.36
CHR-61238	6000	Rear Motor Kit	112-XXXX-005; 113-XXXX-005	77.70
CHR-61252	2000 Note: Not for 106- Bearingless motors.	Buna N Seal Kit	104-XXXX-003;-004;-005 105-XXXX-003;-004;-005	122.85
CHR-61258	2000	Buna N Seal Kit	104-XXXX-006; 105-XXXX-006	123.35
CHR-61259	2000 Note: Does not fit 106-XXXX-003;-004;-005 motors	Buna N Seal Kit	106-XXXX-006	59.86
CHR-64417	Steering unit with external shaft			47.67
CHR-64418	Steering unit with internal spline			82.05

CHAR-LYNN®

## CHIEF™ CYLINDERS

Kit Number	Code (Pg. xviii)	Rod X Bore Size	List Price	Kit Number	Code (Pg. xviii)	Rod X Bore Size	List Price
CTR-203-001	P-OB-3	1-1/8" x 2"	\$ 8.64	CTR-781-036	I-U-1	4" Rod Kit	\$ 42.17
CTR-203-002	P-OB-3	1-1/8" x 2-1/2"	9.05	CTR-781-038	I-U-1	5" Rod Kit	64.04
CTR-203-004	P-OB-3	1-1/4" x 3-1/2"	10.30	CTR-781-039	I-U-1	1-1/8" Rod Kit	11.02
CTR-203-005	P-OB-3	1-1/2" x 3-1/2"	10.64	CTR-781-042	I-U-1	2-3/4" Rod Kit	26.22
CTR-203-006	P-OB-3	1-1/4" x 4"	10.14	CTR-781-043	I-U-1	1" Rod Kit	10.07
CTR-203-011	P-OB-3	1-1/4" x 2-3/8"	8.39	CTR-781-044	I-U-1	1-1/8" Rod Kit	11.37
CTR-203-029	P-OB-3	1-1/2" x 3"	10.07	CTR-781-049	I-U-1	2" Rod Kit	20.00
CTR-203-150	P-U-10	1" x 1-1/2"	13.17	CTR-781-100	N-N-10	2" Piston Kit	7.48
CTR-203-151	P-U-10	1-1/4" x 2"	18.26	CTR-781-101	N-N-10	2-1/2" Piston Kit	7.73
CTR-203-152	P-U-10	1-3/8" x 2-1/2"	19.42	CTR-781-102	N-N-10	3" Piston Kit	12.61
CTR-203-153	P-U-10	1-1/2" x 3"	19.95	CTR-781-103	N-N-10	3-1/2" Piston Kit	12.84
CTR-781-007	I-U-1	1-1/2" Rod Kit	16.11	CTR-781-104	N-N-10	4" Piston Kit	13.73
CTR-781-009	I-U-1	2" Rod Kit	19.70	CTR-781-105	N-N-10	4-1/2" Piston Kit	16.18
CTR-781-013	I-U-1	1-3/4" Rod Kit	14.16	CTR-781-107	N-N-10	5-1/2" Piston Kit	17.94
CTR-781-014	I-U-1	2" Rod Kit	23.25	CTR-781-108	N-N-10	6" Piston Kit	23.66
CTR-781-015	I-U-1	2-1/4" Rod Kit	24.01	CTR-781-201	N-N-10	7" Piston Kit	32.98
CTR-781-020	I-U-1	2" Rod Kit	22.56	CTR-781-203	N-N-10	9" Piston Kit	71.76
CTR-781-021	I-U-1	2-1/2" Rod Kit	27.11	CTR-781-204	N-N-10	10" Piston Kit	106.20
CTR-781-022	I-U-1	2-3/4" Rod Kit	27.35	CTR-781-206	N-N-10	12" Piston Kit	175.71
CTR-781-028	I-U-1	3" Rod Kit	29.72	CTR-781-303	I-U-1	4" Rod Kit	30.66
CTR-781-029	I-U-1	3 1/2" Rod Kit	33.38	CTR-781-305	I-U-1	2-1/4" Rod Kit	17.11
CTR-781-030	I-U-1	4" Rod Kit	37.44	CTR-781-310	I-U-1	1-1/4" Rod Kit	10.48
CTR-781-034	I-U-1	4" Rod Kit	39.98	CTR-781-312	I-U-1	1-3/4" Rod Kit	13.58
CTR-781-035	I-U-1	3-1/2" Rod Kit	41.02	CTR-781-313	I-U-1	2" Rod Kit	15.41

## CLARK® LIFT TRUCKS

**NOTE:** A CLARK® deck number can positively identify the kit needed for lift cylinders. Looking at the upright (lift mechanism) from the driver's seat, the deck number is stamped on the right outer channel.

**SAMPLE:** MO141, HO351, FO168, etc.

**ALSO NOTE:** Kits with an "E" suffix contain original equipment u-seals. Kits without "E" suffix contain ® Sealing Products designed seals.

Kit Number	Code (Pg. xviii)	Rod X Bore Size	List Price	Kit Number	Code (Pg. xviii)	Rod X Bore Size	List Price
CLK-1795529	I-U-5	1-1/2 X 4	\$ 60.35	CLK-1811179	I-V-5	1-1/2 X 4	\$ 81.80
CLK-1810820	O-RINGS		10.55	CLK-1811180	I-V-5	1-1/4 X 4	74.99
CLK-1811046	I-U-10	1-1/4 X 3	25.28	CLK-1811184	I-V-5	1-1/4 X 3	81.61
CLK-1811107	I-N-4	2 X 2-1/4	26.19	CLK-1811200	I-V-4	2 X 6	148.01
CLK-1811108	I-N-4	2-1/4 X 2-1/2	20.26	CLK-1811200-E	I-V-4	2 X 6	277.73
CLK-1811120		1-3/4, 3-1/8 VID, 3-7/8, 5-1/4 UID	146.59	CLK-1811204	I-V-1	1-1/4 ROD	81.15
CLK-1811120-E		1-3/4, 3-1/8 VID, 3-7/8, 5-1/4 UID	237.89	CLK-1811206	I-V-5	3/4 X 1-5/8	37.37
CLK-1811122		2-1/8 VID, 3-7/8, 4-3/4, 6-1/2 UID	196.81	CLK-1811207	I-V-5	1 X 2	54.23
CLK-1811122-E		2-1/8 VID, 3-7/8, 4-3/4, 6-1/2 UID	273.96	CLK-1811209	I-V-5	1 X 2-1/4	61.15
CLK-1811123-E		3-1/4, 4-1/4 VID'S, 6-1/2 UID'S	288.85	CLK-1811210	I-V-5	1-1/4 X 2-3/4	75.73
CLK-1811124		2-1/8, 3-1/8 VID'S	85.14	CLK-1811212	I-V-5	1-1/4 X 3-1/4	78.86
CLK-1811125		2-1/8, 3-1/8, 4-1/2 VID'S	193.74	CLK-1811217	I-V-5	1-3/4 X 4-1/2	59.89
CLK-1811126		2-3/4, 3-3/4, 5-3/4 VID'S	205.19	CLK-1811218	I-V-5	2 X 6	323.80
CLK-1811127		2-3/4, 3-3/4, 5-3/4 VID'S	209.93	CLK-1811231	N-N-5	2.26" Piston Kit	40.70
CLK-1811129	I-N-4	2-1/2 X 4	42.48	CLK-1811244	I-U-10	1-1/8 X 2-1/4	26.35
CLK-1811130		1-3/4, 2-5/8, 3-3/4 VID'S	122.57	CLK-1811275	I-V-5	1-1/2 X 4	61.87
CLK-1811131		1-3/4, 3-1/8 VID, 3-7/8, 5-1/4 UID	157.05	CLK-1811309	I-U-10	1 X 3	14.10
CLK-1811131-E		1-3/4, 3-1/8 VID, 3-7/8, 5-1/4 UID	214.31	CLK-1811314		1-3/4 VID, 3-1/8, 3-7/8, 5-1/4 UID	129.96
CLK-1811132		1-3/4, 2-5/8 VID, 3-3/8, 4-1/2 UID	111.74	CLK-1811314-E		1-3/4 VID, 3-1/8, 3-7/8, 5-1/4 UID	185.78
CLK-1811132-E		1-3/4, 2-5/8 VID, 3-3/8, 4-1/2 UID	174.36	CLK-1811315		1-3/4 VID, 3-1/8, 3-7/8, 5-1/4 UID	148.08
CLK-1811133		1-3/4, 2-5/8 VID'S	58.09	CLK-1811315-E		1-3/4 VID, 3-1/8, 3-7/8, 5-1/4 UID	188.49
CLK-1811142		1-3/4, 2-5/8, 3-3/4 VID'S	199.97	CLK-1811327		2-1/8 VID, 3-7/8, 4-3/4, 6-1/2 UID	173.62
CLK-1811148		2-1/8 VID, 3-7/8, 4-3/4, 6-1/2 UID	206.42	CLK-1811327-E		2-1/8 VID, 3-7/8, 4-3/4, 6-1/2 UID	273.65
CLK-1811148-E		2-1/8 VID, 3-7/8, 4-3/4, 6-1/2 UID	274.89	CLK-1811369	P-U-4	60 mm X 73 mm	65.39
CLK-1811149	I-U-4	3-1/2 X 4-3/4	94.68	CLK-1811376	I-U-10	40 mm X 4"	48.96
CLK-1811154	I-U-1	2-1/2 X 3-1/4	27.43	CLK-1811392	P-U-10	1-3/4 X 3	63.70
CLK-1811155	I-N-4	2-1/2 X 3	25.89	CLK-1811393	I-U-10	40 mm X 4"	54.17
CLK-1811157	I-U-5	5 X 7	174.65	CLK-1811415	P-U-4	60 X 78 mm	69.68
CLK-1811158	I-U-5	4-1/2 X 6	134.75	CLK-1811537	P-U-1	60 mm	68.16
CLK-1811158-E	I-U-5	4-1/2 X 6	163.63	CLK-1811538	I-U-4	40 X 56 mm	57.87
CLK-1811159		1-3/4, 3-1/8 VID, 3-7/8, 5-1/4 UID	148.27	CLK-1811542	I-U-10	1-3/8 X 3	31.67
CLK-1811159-E		1-3/4, 3-1/8 VID, 3-7/8, 5-1/4 UID	215.18	CLK-1811544	I-U-10	1 X 2	52.66
CLK-1811160		1-3/4, 2-5/8 VID, 3-3/8, 4-1/2 UID	110.94	CLK-1811569	P-U-10	2 X 3-3/8	48.03
CLK-1811160-E		1-3/4, 2-5/8 VID, 3-3/8, 4-1/2 UID	174.36	CLK-1811582	I-U-10	1-1/4 X 3-1/2	29.23
CLK-1811161		1-3/4, 3-1/8 VID, 3-7/8, 5-1/4 UID	149.41	CLK-1811691	P-U-1	2 X 2.450	33.36
CLK-1811161-E		1-3/4, 3-1/8 VID, 3-7/8, 5-1/4 UID	208.28	CLK-1811697	I-U-10	1-1/4 X 3-1/2	30.74
CLK-1811162		2-1/8, 3-1/8, 4-1/2 UID'S	158.93	CLK-1811719	I-U-10	40 mm X 3-1/2	34.93
CLK-1811163		2-1/8, 3-1/8, 4-1/2 VID'S	196.05	CLK-1811759	I-U-10	1-1/4 X 3	30.21
CLK-1811164		1-3/4, 2-5/8, 3-3/8, 4-5/8 UID'S	99.08	CLK-1811785	I-U-10	40 mm x 3-1/2	40.86
CLK-1811164-E		1-3/4, 2-5/8, 3-3/8, 4-5/8 UID'S	193.79	CLK-1811799	I-U-10	2 X 3-3/8	77.36

## CLARK® LIFT TRUCKS

Kit Number	Code (Pg. xviii)	Rod X Bore Size	List Price
CLK-1811820	I-U-10	2 X 3	\$ 30.71
CLK-1811828	I-U-10	2 X 3	27.14
CLK-1811852	I-U-1	3 X 3-1/2	60.29
CLK-1811855	P-U-1	60 mm X 72 mm	42.03
CLK-1811972	I-U-10	1-1/4 X 3	38.41
CLK-1813014	P-U-1	2 X 2-1/2	41.39
CLK-1813015	I-U-1	2-5/8 Rod Kit	67.43
CLK-1813016	I-U-1	3 X 3-1/2	53.43
CLK-1813017	P-U-1	60mm X 72 mm	42.03
CLK-1813023	I-U-1	40 mm X 2-3/16"	40.43
CLK-1813024	I-U-1	40 mm Rod Kit	20.18
CLK-1813032	I-U-10	50 mm X 3-3/8"	64.52
CLK-1813055	I-U-10	50 mm X 3-1/8"	69.94
CLK-1813075	I-U-10	40 mm X 3-1/2"	39.96
CLK-1813076	I-U-10	40 mm X 4"	42.70
CLK-1813082	I-U-10	50 X 86 mm	59.06
CLK-1813084	I-U-1	50 mm Rod Kit	23.19
CLK-1813176	I-U-4	60 X 73 mm	72.61
CLK-1818816	P-U-10	3/4 X 1-3/4	25.89
CLK-1818864	P-U-10	3/4 X 2	19.22
CLK-1821328	I-U-10	7/8 X 2	13.49
CLK-1830350	I-N-4	2 X 2-1/4	28.31
CLK-1830352	I-N-4	3-1/4 X 4	42.83
CLK-1830358	I-N-4	2-1/2 X 3-1/4	50.57
CLK-1830360	I-N-4	2-1/2 X 3	28.83
CLK-1830361	I-N-4	2-1/4 X 2-1/2	32.57
CLK-1830649	I-U-10	3/4 X 2-3/4	31.38
CLK-1831042		1-1/4" Rod Kit	9.35

Kit Number	Code (Pg. xviii)	Rod X Bore Size	List Price
CLK-1831074	I-U-10	1-3/4 X 4-1/2	\$ 41.65
CLK-1831075	I-V-1	3-1/4 Rod Kit	41.54
CLK-1831076	I-U-10	1-1/8 X 2-1/2	26.19
CLK-1991085	P-TR-10	2 X 4	39.38
CLK-2367420	I-U-1	2-1/4 X 3-1/4	99.84
CLK-3009626	P-U-10	25 mm X 50 mm	66.30
CLK-3986876	MOTOR KIT		27.90
CLK-841270	P-U-10	2 X 3-3/4	34.03
CLK-886547	P-TR-12	1 X 2	46.79
CLK-896505	MOTOR KIT		6.96
CLK-905074	MOTOR KIT		15.38
CLK-907984	VALVE KIT		17.40
CLK-908985	VALVE KIT		16.62
CLK-912339	P-U-1	2-1/2 X 3	37.31
CLK-914698	I-U-4	1 X 2-1/2	26.40
CLK-914703	I-O-4	1-1/4 X 3	17.64
CLK-917282	O-RING KIT		7.63
CLK-917713	N-N-10	2" Piston Kit	21.36
CLK-918886	I-U-10	2 X 3-3/8	37.68
CLK-921115A	VALVE KIT		10.12
CLK-990076	VALVE KIT		4.26
CLK-990208	SWIVEL KIT		6.81
CLK-990209	SWIVEL KIT		10.18
CLK-992511	O-RING KIT		6.98
CLK-994287	VALVE KIT		12.04
CLK-995815	SWIVEL KIT		10.18
CLK-999820	P-U-10	3/4 X 1-3/4	33.54

CLARK®

**FOR CLARK®-MICHIGAN CONSTRUCTION EQUIPMENT  
SEE OUR LISTING OF KITS UNDER THE VOLVO SECTION IN THIS CATALOG.**

### U-SEALS

Part Number	Rod Dia.	List Price
CLK-2377669	48 mm	\$ 20.21
CLK-2791698	50 mm	13.78
CLK-2793753	40 mm	12.91
CLK-328300	1	7.71

### PISTON U-SEALS

Part Number	Bore Dia.	List Price
CLK-1650143	2.266	\$ 15.07

### O-RINGS

Part Number	Min Pkg Qty	List Price
CLK-1301093	20	\$ 0.48
CLK-2825250	1	6.08

### BACK-UP RINGS

Part Number	Min Pkg Qty	List Price
CLK-994384	2	\$ 2.38

### WIPERS

Part Number	Rod Dia.	List Price
CLK-1657085	1-1/4	\$ 2.89

### VEE SETS

Part Number	Rod Dia.	List Price
CLK-1665683	1-1/4	\$ 22.08



# COMMERCIAL® HYDRAULICS

**PACKING:** Vee packing with nylon top and bottom adaptors. 5/16" cross section.

**WIPERS:** .190 shoulder thickness on wipers.

**BEARINGS:** One above packing - may be either bronze or nylon.

**PISTON:** Welded to stage. Single action uses single nylon wear ring. Double action uses 3 cast iron piston rings and 2 nylon wear rings.

**STAGE O.D.'s:** 2.750; 3.750; 4.750; 5.750; 6.750; 7.905; 9.375

**SPECIAL INFO.:** Threaded internal stop ring. Uses wave spring under vee packing.

**IDENTIFICATION:** Cylinder number stamped on metal tag on cylinder body.  
Ex: SD85MC-15-220 double acting  
S85DC-40-190 single acting

## COMMERCIAL

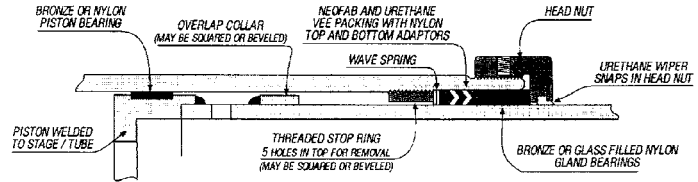

COMMERCIAL® HYDRAULICS

CYLINDER REBUILD KITS SINGLE ACTING DUMP BODY CYLINDERS		
Kit includes: Wiper Rings, Packing Assemblies, Bearing Rings, Piston Bearings, Wave Springs, Set Screws & Nylon Balls		
Part Number	Cyl. Model Number	List Price
CM-375-1804-017	S53	\$ 164.81
CM-375-1804-020	S62	150.75
CM-375-1804-018	S63	205.31
CM-375-1804-021	S64	247.72
CM-375-1804-019	S73	259.52
CM-375-1804-022	S74	338.76
CM-375-1804-023	S84	391.36
CM-375-1804-024	S85	463.36
CM-375-1804-025	S95	671.05
CYLINDER REPACK KITS SINGLE ACTING DUMP BODY CYLINDERS		
Kit includes: Wiper Rings, Packing Assemblies		
Part Number	Cyl. Model Number	List Price
CM-391-1804-020	S53	\$ 71.14
CM-375-1804-026	S62	86.01
CM-391-1804-109	S63	90.06
CM-391-1804-237	S64	108.38
CM-375-1804-002	S73	120.91
CM-375-1804-003	S74	144.31
CM-391-1804-054	S84	230.37
CM-391-1804-060	S85	201.97
CM-375-1804-004	S95	376.49
Part Number	Description	List Price
PACKING & WIPERS (INCLUDES SHIMS)		
CM-3VSW	2-3/4" Vee Set & Wiper	\$ 24.68
CM-4VSW	3-3/4" Vee Set & Wiper	32.02
CM-5VSW	4-3/4" Vee Set & Wiper	40.02
CM-6VSW	5-3/4" Vee Set & Wiper	50.97
CM-7VSW	6-3/4" Vee Set & Wiper	74.03
CM-8VSW	7.905" Vee Set & Wiper	78.75
CM-9.37VSW	9-3/8" Vee Set & Wiper	162.57

Part Number	Description	List Price
GLAND BEARINGS		
CM-275NB	2-3/4" Gland Bearing	\$ 17.00
CM-375NB	3-3/4" Gland Bearing	17.03
CM-475NB	4-3/4" Gland Bearing	26.12
CM-575NB	5-3/4" Gland Bearing	30.04
CM-675NB	6-3/4" Gland Bearing	31.54
CM-790NB	7.905" Gland Bearing	47.55
CM-937NB	9-3/8" Gland Bearing	103.34
GLAND BEARINGS KITS		
CM-NYB35	2-3/4" - 4-3/4" Gland Bearings	\$ 55.67
CM-NYB46	3-3/4" - 5-3/4" Gland Bearings	67.73
CM-NYB47	3-3/4" - 6-3/4" Gland Bearings	97.67
CM-NYB48	3-3/4" - 7.905" Gland Bearings	142.77
CM-NYB49	3-3/4" - 9-3/8" Gland Bearings	307.63
CM-NYB57	4-3/4" - 6-3/4" Gland Bearings	81.93
CM-NYB58	4-3/4" - 7.905" Gland Bearings	127.53
PISTON BEARINGS		
CM-391-2684-123	2-3/4" Piston Bearing	\$ 4.28
CM-391-2684-069	3-3/4" Piston Bearing	6.38
CM-391-2684-070	4-3/4" Piston Bearing	6.45
CM-391-2684-071	5-3/4" Piston Bearing	7.29
CM-391-2684-072	6-3/4" Piston Bearing	8.36
CM-391-2684-098	9-3/8" Piston Bearing	20.04
NYLON PISTON BEARINGS		
CM-U3023-32	2-3/4" Piston Bearing	\$ 4.28
CM-U3023-42	3-3/4" Piston Bearing	6.38
CM-U3023-52	4-3/4" Piston Bearing	6.45
CM-U3023-62	5-3/4" Piston Bearing	7.29
CM-U3023-72	6-3/4" Piston Bearing	8.36
CM-U3023-84	7.905" Piston Bearing	9.89
CM-U3023-98	9-3/8" Piston Bearing	20.04
CM-X29-1	Bleeder Valve	5.18
BRONZE PISTON BEARINGS		
CM-375-9023-038	4-3/4" Bronze Piston Bearings	\$ 77.04
CM-U3023-52B	4-3/4" Bronze Piston Bearings	77.04
CM-375-9023-039	5-3/4" Bronze Piston Bearings	86.30
CM-U3023-62B	5-3/4" Bronze Piston Bearings	86.30

## COMMERCIAL® HYDRAULICS

Part Number	Description	List Price
<b>BRONZE PISTON BEARINGS</b>		
CM-375-9023-040	6-3/4" Bronze Piston Bearings	\$ 90.01
CM-U3023-72B	6-3/4" Bronze Piston Bearings	90.01
CM-375-9023-041	7.905" Bronze Piston Bearings	105.27
CM-U3023-84B	7.905" Bronze Piston Bearings	105.27
CM-375-9023-042	9-3/8"-stage Bronze Piston Bearings	266.44
CM-U3023-98B	9-3/8" Bronze Piston Bearings	266.44
<b>PISTON RINGS (Double Acting)</b>		
CM-X78-4-25	3-3/4" Piston Ring	\$ 11.45
CM-X78-5-25	4-3/4" Piston Ring	15.07
CM-X78-6-25	5-3/4" Piston Ring	17.78
CM-X78-7-25	6-3/4" Piston Ring	26.34
CM-X78-8-437	7.905" Piston Ring	36.58
CM-X78-9-88	9-3/8" Piston Ring	77.13
<b>KITS</b>		
CM-35	2-3/4" - 4-3/4" Vee Sets & Wipers	\$ 71.14
CM-36	2-3/4" - 5-3/4" Vee Sets & Wipers	108.38
CM-38	2-3/4" - 7.905" Vee Sets & Wipers	220.37
CM-46	3-3/4" - 5-3/4" Vee Sets & Wipers	90.06
CM-47	3-3/4"-6-3/4" Vee Sets & Wipers	144.31
CM-48	3-3/4"-7.905" Vee Sets & Wipers	201.97
CM-49	3-3/4"-9-3/8" Vee Sets & Wipers	414.23
CM-56	4-3/4 - 5-3/4" Vee Sets & Wipers	86.01
CM-57	4-3/4"-6-3/4" Vee Sets & Wipers	120.91
CM-58	4-3/4"-7.905" Vee Sets & Wipers	230.37
CM-59	5"-9" Vee Sets & Wipers	376.49
CM-69	5-3/4"-9-3/8" Vee Sets & Wipers	294.01
CM-NPB35	2-3/4"-4-3/4" Piston Bearings	20.92
CM-NPB36	2-3/4"-5-3/4" Piston Bearings	59.24
CM-NPB46	3-3/4"-5-3/4" Piston Bearing	49.26
CM-NPB47	3-3/4"-6-3/4" Piston Bearings	34.87
CM-NPB48	3-3/4"-7.905" Piston Bearings	93.74
CM-NPB57	4-3/4"-6-3/4" Piston Bearings	27.04
CM-NPB58	4-3/4"-7.905" Piston Bearings	78.11
CM-NYB35	2-3/4"-4-3/4" Gland Bearings	55.67
CM-NYB36	2-3/4"-5-3/4" Gland Bearings	83.79
CM-NYB47	3-3/4"-6-3/4" Gland Bearings	97.67
CM-NYB48	3-3/4"-7.905" Gland Bearings	142.77
CM-NYB57	4-3/4"-6-3/4" Gland Bearings	81.93
CM-NYB58	4-3/4"-7.905" Gland Bearings	127.53
CM-NYB69	5-3/4"-9-3/8" Gland Bearings	152.39
CM-PR48	3-3/4"-7.905" Piston Rings	358.14
CM-PR58	4-3/4"-7.905" Piston Rings	313.22
<b>THREADED STOPS</b>		
CM-F3020	3-3/4" Threaded Stop Ring	\$ 93.54
CM-F4020	2-3/4" Threaded Stop Ring	95.96
CM-F5020	5-3/4" Threaded Stop Ring	105.27
CM-F6020	4-3/4" Threaded Stop Ring	110.81

Part Number	Description	List Price
<b>THREADED STOPS</b>		
CM-F7020	6-3/4" Threaded Stop Ring	\$ 121.95
CM-F9020	9-3/8" Threaded Stop Ring	294.08
CM-G8020	7.905" Threaded Stop Ring	137.07
<b>HEAD NUTS (MEASURED AT WIPER I.D.)</b>		
CM-MA3011-37	3-3/4" Bronze Internal Head Nut	\$ 125.99
CM-MA3011-47	4-3/4" Bronze Internal Head Nut	150.15
CM-MA3011-57	5-3/4" Bronze Internal Head Nut	193.94
CM-MA3011-67	6-3/4" Bronze Internal Head Nut	218.97
CM-MA3011-79	7.905" Bronze Internal Head Nut	286.53
CM-MA3011-93	9-3/8" Bronze Internal Head Nut	495.55
CM-391-1470-162	2-3/4" Steel External Head Nut	84.46
CM-YA3011-27	2-3/4" Steel External Head Nut	84.46
CM-391-1470-163	3-3/4" Steel External Head Nut	109.55
CM-YA3011-37	3-3/4" Steel External Head Nut	109.55
CM-391-1470-164	4-3/4" Steel External Head Nut	112.90
CM-YA3011-47	4-3/4" Steel External Head Nut	112.90
CM-391-1470-165	5-3/4" Steel External Head Nut	138.92
CM-YA3011-57	5-3/4" Steel External Head Nut	138.92
CM-391-1470-166	6-3/4" Steel External Head Nut	180.29
CM-YA3011-67	6-3/4" Steel External Head Nut	180.29
CM-YA3011-79	7.905" Steel External Head Nut	256.30
CM-YA3011-93	9-3/8" Steel External Head Nut	479.46
<b>VALVE SERVICE KITS</b>		
CM-391-1803-030	Valve Series A20 Service Kit	\$ 6.50
CM-391-1803-201	Valve Series A35 Service Kit	31.84
<b>WAVE SPRINGS</b>		
CM-P1327-27	2-3/4" Wave Spring	\$ 17.39
CM-391-3581-320	2-3/4" Wave Spring	17.39
CM-375-9327-003	3-1/8" Wave Spring	13.93
CM-P1327-37	3-3/4" Wave Spring	11.77
CM-391-3581-300	3-3/4" Wave Spring	11.77
CM-391-3581-300	3-3/4" Wave Spring	11.77
CM-375-9327-008	4-1/8" Wave Spring	10.59
CM-P1327-47	4-3/4" Wave Spring	13.94
CM-391-3581-301	4-3/4" Wave Spring	13.94
CM-P1327-57	5-3/4" Wave Spring	14.06
CM-391-3581-302	5-3/4" Wave Spring	14.06
CM-P1327-67	6-3/4" Wave Spring	38.22
CM-391-3581-303	6-3/4" Wave Spring	38.22
CM-P1327-79	7.905" Wave Spring	55.28
CM-P1327-93	9-3/8" Wave Spring	88.44
CM-391-3581-310	9-3/8" Wave Spring	88.44
<b>MISCELLANEOUS</b>		
CM-391-1281-005	Grease Fitting 1/8 NPT	\$ 1.01
CM-375-2686-010	Lock Wire	12.24
CM-391-1431-121	Set Screw	0.93



# REPLACEMENT PARTS FOR COMMERCIAL® EQUIPMENT

**NOTE:** Commercial part numbers are used as a reference only. We do not imply that these kits are original REPLACEMENT PARTS.

COMMERCIAL® HYDRAULICS

U-SEALS		
Part Number	Rod Dia.	List Price
CM-220004	3/4	\$ 4.42
CM-220005	3/4	4.73
CM-22001	3/4	5.12
CM-22016	7/8	4.91
CM-22017	7/8	4.90
CM-22202	7/8	5.43
CM-22002	1	5.46
CM-22066	1	5.46
CM-22074	1	5.11
CM-22224	1	5.46
CM-23011	1	4.52
CM-23086	1	4.56
CM-23223	1	5.01
CM-23224	1	4.56
CM-22010	1-1/8	7.79
CM-22014	1-1/8	4.59
CM-22020	1-1/8	5.70
CM-22220	1-1/8	5.32
CM-23226	1-1/8	8.10
CM-22003	1-1/4	5.42
CM-22216	1-1/4	6.38
CM-22217	1-1/4	6.07
CM-23096	1-1/4	5.24
CM-23097	1-1/4	5.06
CM-23098	1-1/4	4.85
CM-23228	1-1/4	5.24
CM-23229	1-1/4	5.22
CM-375-9006-028	1-1/4	5.74
CM-391-1982-903	1-1/4	6.38
CM-22021	1-3/8	6.20
CM-22022	1-3/8	7.33
CM-22045	1-3/8	6.60
CM-23231	1-3/8	5.53
CM-23406	1-3/8	6.85
CM-22059	1-1/2	5.99
CM-22065	1-1/2	6.29
CM-22082	1-1/2	7.25
CM-22221	1-1/2	5.56
CM-22227	1-1/2	7.25
CM-23105	1-1/2	6.09
CM-23106	1-1/2	6.07
CM-23233	1-1/2	5.91
CM-23234	1-1/2	5.91
CM-391-1982-905	1-1/2	7.25
CM-22056	1.062	4.51
CM-22006	1-5/8	5.93
CM-22083	1-5/8	7.89

U-SEALS		
Part Number	Rod Dia.	List Price
CM-22205	1-5/8	\$ 7.03
CM-22230	1-5/8	7.89
CM-23109	1-5/8	6.17
CM-22004	1-3/4	9.78
CM-22042	1-3/4	7.92
CM-22204	1-3/4	7.12
CM-22231	1-3/4	7.12
CM-23112	1-3/4	6.38
CM-23114	1-3/4	6.27
CM-23141	1-3/4	7.61
CM-23238	1-3/4	6.73
CM-23239	1-3/4	8.84
CM-23414	1-3/4	7.61
CM-375-9006-087	1-3/4	7.12
CM-391-1982-900	1-3/4	7.92
CM-22102	1-7/8	10.20
CM-22005	2	8.68
CM-22049	2	7.92
CM-22073	2	6.29
CM-22076	2	7.91
CM-22203	2	6.29
CM-23118	2	7.16
CM-23119	2	6.67
CM-23246	2	7.55
CM-23247	2	7.38
CM-23248	2	7.02
CM-23249	2	6.79
CM-23920	2	7.38
CM-375-9006-411	2	14.94
CM-391-1982-899	2	8.68
CM-22222	2-1/8	6.50
CM-22007	2-1/4	6.94
CM-22064	2-1/4	9.74
CM-22078	2-1/4	11.72
CM-23253	2-1/4	8.50
CM-23427	2-1/4	10.47
CM-391-1982-890	2-1/4	9.74
CM-23432	2-3/8	10.16
CM-375-9006-174	2-3/8	9.60
CM-22009	2-1/2	10.72
CM-22025	2-1/2	9.58
CM-22026	2-1/2	17.33
CM-22050	2-1/2	9.53
CM-22060	2-1/2	7.14
CM-22061	2-1/2	10.72
CM-22079	2-1/2	9.53
CM-22207	2-1/2	12.48

U-SEALS		
Part Number	Rod Dia.	List Price
CM-23134	2-1/2	\$ 8.28
CM-23259	2-1/2	9.59
CM-23260	2-1/2	9.41
CM-23433	2-1/2	10.85
CM-23576	2-1/2	13.39
CM-375-9006-173	2-1/2	9.53
CM-375-9006-432	2-1/2	10.70
CM-391-1982-891	2-1/2	12.48
CM-22028	2-5/8	7.14
CM-22029	2-5/8	11.18
CM-23136	2-5/8	8.67
CM-23578	2-5/8	15.16
CM-22030	2-3/4	10.37
CM-22100	2-3/4	11.71
CM-22101	2-3/4	10.37
CM-23264	2-3/4	10.14
CM-23581	2-3/4	15.57
CM-375-9006-088	2-3/4	10.37
CM-391-1982-902	2-3/4	13.56
CM-22215	2-7/8	14.63
CM-375-9006-154	2-7/8	11.11
CM-22011	3	14.67
CM-22031	3	12.65
CM-22032	3	11.18
CM-22044	3	21.55
CM-22047	3	20.58
CM-23268	3	10.63
CM-23269	3	10.27
CM-23446	3	18.95
CM-23586	3	17.17
CM-375-9006-092	3	11.52
CM-375-9006-108	3	20.58
CM-375-9006-238	3	12.65
CM-375-9006-343	3	20.04
CM-375-9006-430	3	26.76
CM-391-1982-909	3	14.67
CM-23149	3-1/8	9.85
CM-22068	3-1/4	13.62
CM-22081	3-1/4	13.62
CM-22210	3-1/4	14.21
CM-23273	3-1/4	11.76
CM-23274	3-1/4	10.95
CM-23593	3-1/4	17.45
CM-375-9006-431	3-1/4	11.76
CM-391-1982-892	3-1/4	16.47
CM-22012	3-1/2	23.41
CM-22051	3-1/2	23.41

# REPLACEMENT PARTS FOR COMMERCIAL® EQUIPMENT

**NOTE:** Commercial part numbers are used as a reference only. We do not imply that these kits are original REPLACEMENT PARTS.

## U-SEALS

Part Number	Rod Dia.	List Price
CM-22072	3-1/2	\$ 17.79
CM-22085	3-1/2	14.60
CM-22096	3-1/2	13.41
CM-23279	3-1/2	12.50
CM-391-1982-120	3-1/2	17.79
CM-391-1982-910	3-1/2	13.75
CM-22018	3-5/8	10.37
CM-22069	3-5/8	25.30
CM-22089	3-5/8	24.25
CM-22095	3-5/8	25.30
CM-22041	3-3/4	19.69
CM-22228	3-3/4	18.93
CM-23286	3-3/4	12.97
CM-23604	3-3/4	23.67
CM-375-9006-319	3-3/4	24.89
CM-375-9006-349	3-3/4	24.89
CM-391-1982-894	3-3/4	19.69
CM-375-9006-043	3-7/8	19.69
CM-22034	4	19.26
CM-22053	4	12.39
CM-22055	4	16.80
CM-22098	4	16.80
CM-23291	4	13.24
CM-23292	4	14.07
CM-23293	4	13.75
CM-23294	4	17.83
CM-375-9006-019	4	16.80
CM-375-9006-054	4	26.42
CM-391-1982-904	4	19.26
CM-22035	4-1/4	20.11
CM-22048	4-1/4	20.11
CM-22209	4-1/4	27.66
CM-22219	4-1/4	20.25
CM-23616	4-1/4	24.00
CM-23617	4-1/4	22.84
CM-23618	4-1/4	24.00
CM-375-9006-257	4-1/4	12.82
CM-391-1982-893	4-1/4	20.25
CM-22036	4-1/2	29.05
CM-22088	4-1/2	19.92
CM-22214	4-1/2	21.94
CM-23304	4-1/2	16.41
CM-23306	4-1/2	16.41
CM-23621	4-1/2	32.81
CM-375-9006-096	4-1/2	21.94
CM-375-9006-145	4-1/2	19.92
CM-375-9006-403	4-1/2	45.79

## U-SEALS

Part Number	Rod Dia.	List Price
CM-375-9006-407	4-1/2	\$ 28.96
CM-22058	4-5/8	21.19
CM-375-9006-182	4-5/8	23.56
CM-22052	4-3/4	21.87
CM-22218	4-3/4	24.44
CM-23630	4-3/4	24.97
CM-375-9006-246	4-3/4	16.85
CM-375-9006-280	4-3/4	30.36
CM-391-1982-895	4-3/4	24.44
CM-22037	5	23.05
CM-22087	5	37.42
CM-22094	5	26.33
CM-22290	5	26.33
CM-23318	5	32.97
CM-23320	5	32.97
CM-23670	5	37.21
CM-375-9006-434	5	31.73
CM-375-9006-457	5	27.84
CM-391-1982-908	5	26.33
CM-23638	5-1/4	27.08
CM-23639	5-1/4	27.96
CM-23640	5-1/4	28.41
CM-23493	5-3/8	25.60
CM-23494	5-3/8	24.97
CM-23495	5-3/8	23.19
CM-22038	5-1/2	26.91
CM-22039	5-1/2	26.14
CM-22040	5-1/2	34.43
CM-23330	5-1/2	28.46
CM-23331	5-1/2	28.46
CM-23645	5-1/2	29.00
CM-375-9006-316	5-1/2	26.14
CM-375-9006-450	5-1/2	34.43
CM-22091	5-3/4	29.29
CM-23658	5-3/4	28.91
CM-375-9006-281	5-3/4	37.27
CM-391-1982-896	5-3/4	31.91
CM-22054	6	27.32
CM-22070	6	36.84
CM-375-9006-025	6	27.32
CM-22225	6-1/4	37.76
CM-23659	6-1/4	30.88
CM-23660	6-1/4	33.45
CM-22062	6-1/2	35.39
CM-22092	6-1/2	39.06
CM-375-9006-020	6-1/2	30.97
CM-375-9006-455	6-1/2	49.41

## U-SEALS

Part Number	Rod Dia.	List Price
CM-375-9006-197	6-3/4	\$ 32.28
CM-375-9006-098	7	33.54
CM-375-9006-479	7	231.07
CM-22097	7-1/2	59.85
CM-375-9006-024	8	40.58
CM-375-9006-021	8-1/2	43.46
CM-22063	9	66.17
CM-375-9006-097	9-1/4	71.62

## ROD SEALS

Part Number	Rod Dia.	List Price
CM-391-2881-483	3/4	\$ 6.62
CM-391-2881-745	7/8	7.53
CM-391-2881-739	1	6.62
CM-391-2881-617	1-1/4	6.76
CM-22082-621	1-1/2	17.35
CM-391-2881-736	1-1/2	7.53
CM-391-2881-740	1-3/4	6.97
CM-22005-621	2	20.88
CM-391-2881-679	2	7.76
CM-22009-621	2-1/2	25.72
CM-391-2881-706	2-1/2	9.63
CM-391-2881-743	2-3/4	10.98
CM-22031-621	3	30.54
CM-391-2881-742	3	11.79
CM-391-2881-758	3	11.79
CM-391-2881-737	3-3/4	16.61
CM-391-2881-698	3-7/8	17.14
CM-22098-621	4	39.39
CM-375-9006-388	4	63.56
CM-391-2881-738	4	18.21
CM-391-2881-741	4-1/4	19.83
CM-391-2881-744	5-1/4	36.31

## VEE SETS

Part Number	Rod Dia.	List Price
CM-21039	1-1/2	\$ 12.07



# REPLACEMENT PARTS FOR COMMERCIAL® EQUIPMENT

**NOTE:** Commercial part numbers are used as a reference only. We do not imply that these kits are original REPLACEMENT PARTS.

## PISTON RINGS

Part Number	Bore Dia.	List Price
CM-31150	1-1/2	\$ 6.71
CM-31201	2	10.15
CM-31202	2	9.83
CM-31203	2	12.27
CM-31251	2	9.53
CM-31252	2-1/2	9.53
CM-31302	3	9.91
CM-31303	3	10.29
CM-31304	3	10.35
CM-31321	3-1/4	9.91
CM-31322	3-1/4	9.91
CM-31323	3-1/4	10.04
CM-375-9078-024	3.49	10.42
CM-31351	3-1/2	10.42
CM-31352	3-1/2	10.42
CM-31353	3-1/2	10.42
CM-391-2681-637	3-1/2	10.42
CM-31375	3-3/4	10.73
CM-31403	3.99	10.83
CM-31402	4	10.43
CM-31404	4	10.83
CM-375-9078-025	4	10.43
CM-31423	4-1/4	11.45
CM-31452	4-1/2	11.45
CM-31453	4-1/2	11.82
CM-31454	4-1/2	11.69
CM-375-9078-026	4-1/2	11.45
CM-391-2681-636	4-1/2	11.82
CM-31475	4-3/4	11.71
CM-31502	5	12.06
CM-31503	5	12.06
CM-31504	5	18.59
CM-31512	5-1/8	17.43
CM-391-2683-019	5.26	15.07
CM-31552	5-1/2	16.29
CM-31553	5-1/2	16.29
CM-31554	5-1/2	16.29
CM-375-9078-016	5-1/2	16.29
CM-375-9078-027	5-1/2	16.29
CM-31575	5-3/4	23.67
CM-31603	6	16.46
CM-31604	6	16.46
CM-31624	6-1/4	25.80
CM-391-2683-024	6.26	17.78
CM-31653	6-1/2	18.84
CM-31654	6-1/2	18.84

## PISTON RINGS

Part Number	Bore Dia.	List Price
CM-31703	7	\$ 21.70
CM-31704	7	29.68
CM-391-2683-029	7.26	26.34
CM-31705	7-1/2	32.61
CM-31803	8	33.00
CM-391-2683-034	8.42	36.58
CM-391-2683-042	9.88	77.13
CM-391-2683-037	10-1/2	150.67

## PISTON SEALS

Part Number	Bore Dia.	List Price
CM-29112	1-1/8	\$ 6.11
CM-29128	1-1/4	5.05
CM-29137	1-3/8	8.52
CM-29138	1-3/8	6.84
CM-29150	1-1/2	5.26
CM-29176	1-3/4	7.94
CM-29200	2	5.69
CM-29201	2	8.86
CM-29202	2	8.86
CM-29225	2-1/4	5.91
CM-29226	2-1/4	9.42
CM-29227	2-1/4	9.92
CM-29250	2-1/2	5.98
CM-29251	2-1/2	9.86
CM-29252	2-1/2	10.00
CM-29252755	2-1/2	6.48
CM-375-9006-200	2-1/2	36.21
CM-29275	2-3/4	6.04
CM-29276	2-3/4	11.77
CM-29277	2-3/4	12.04
CM-375-9006-416	2.999	15.81
CM-29300	3	6.21
CM-29301	3	15.17
CM-29302	3	12.91
CM-29302755	3	8.20
CM-29303	3	15.86
CM-375-9006-329	3	15.86
CM-391-2683-061	3	15.86
CM-391-2881-748	3	9.70
CM-29324	3-1/4	18.85
CM-29325	3-1/4	6.31
CM-29326	3-1/4	15.99

## PISTON SEALS

Part Number	Bore Dia.	List Price
CM-29327	3-1/4	\$ 15.32
CM-29327755	3-1/4	9.73
CM-29328	3-1/4	18.85
CM-29350	3-1/2	6.49
CM-29351	3-1/2	16.47
CM-29352	3-1/2	16.89
CM-29352755	3-1/2	9.88
CM-375-9006-245	3-1/2	20.77
CM-375-9006-334	3-1/2	98.12
CM-375-9006-417	3-1/2	12.83
CM-375-9006-458	3-1/2	15.84
CM-29375	3-3/4	7.04
CM-29376	3-3/4	16.56
CM-29377	3-3/4	19.19
CM-375-9006-172	3-3/4	23.58
CM-391-2882-329	3-3/4	13.97
CM-29400	4	7.16
CM-29401	4	16.92
CM-29402	4	21.33
CM-29402755	4	10.24
CM-29402CT	4	102.96
CM-29403	4	15.23
CM-29404	4	26.21
CM-375-9006-022	4	26.21
CM-375-9006-331	4	26.21
CM-375-9006-419	4	15.23
CM-391-2683-071	4	64.26
CM-29425	4-1/4	7.30
CM-29427	4-1/4	24.63
CM-391-2683-050	4-1/4	30.28
CM-391-2683-079	4-1/4	30.28
CM-375-9006-046	4.265	61.89
CM-29450	4-1/2	7.99
CM-29451	4-1/2	17.09
CM-29452	4-1/2	25.85
CM-29452755	4-1/2	10.64
CM-391-2683-055	4-1/2	31.79
CM-375-9006-256	4.627	52.42
CM-29475	4-3/4	12.43
CM-29476	4-3/4	20.83
CM-29477	4-3/4	26.65
CM-29500	5	8.92
CM-29501	5	21.19
CM-29502	5	27.91
CM-29502755	5	12.65

# REPLACEMENT PARTS FOR COMMERCIAL® EQUIPMENT

**NOTE:** Commercial part numbers are used as a reference only. We do not imply that these kits are original REPLACEMENT PARTS.

## PISTON SEALS

Part Number	Bore Dia.	List Price
CM-29503	5	\$ 34.31
CM-375-9006-495	5	127.60
CM-391-2683-062	5	34.31
CM-375-9006-350	5.001	24.65
CM-375-9006-418	5.001	24.65
CM-29526	5-1/4	22.64
CM-29527	5-1/4	32.88
CM-29529	5-1/4	9.55
CM-391-2683-046	5-1/4	40.42
CM-29550	5-1/2	9.82
CM-29551	5-1/2	24.01
CM-29552	5-1/2	36.77
CM-29552755	5-1/2	17.80
CM-375-9006-211	5-1/2	82.27
CM-29575	5-3/4	10.44
CM-29576	5-3/4	29.38
CM-29577	5-3/4	39.71
CM-29600	6	10.96
CM-29601	6	33.34
CM-29602	6	42.63
CM-29602755	6	18.60
CM-29602CT	6	144.93
CM-391-2683-063	6	52.42
CM-29625	6-1/4	43.05
CM-29650	6-1/2	13.92
CM-29652	6-1/2	43.05
CM-375-9006-264	6-1/2	52.91
CM-29700	7	14.29
CM-29702	7	43.82
CM-29702755	7	19.47
CM-391-2683-080	7	53.87
CM-391-2683-044	7-1/4	53.94
CM-29752	7-1/2	43.94
CM-29800	8	14.53
CM-29802	8	48.96
CM-29802755	8	20.48
CM-391-2683-056	8	61.66
CM-29850	8-1/2	55.38
CM-29851	8-1/2	41.08
CM-375-9006-402	8-1/2	72.39
CM-29902	9	65.50
CM-29902755	9	47.76
CM-391-2683-048	9	83.26
CM-391-2683-057	9-1/2	105.15
CM-29010	10	72.90
CM-29010755	10	56.41

## PISTON SEALS

Part Number	Bore Dia.	List Price
CM-29015	10-1/2	\$ 155.51
CM-391-2683-064	11	204.23
CM-375-9006-193	12	211.83

## WEAR RINGS

Part Number	O.D. X Width	List Price
CM-25000	1-1/4 X 3/8	\$ 3.76
CM-25125	1-1/4 X 1/2	4.57
CM-25122	1-1/2 X 3/8	3.76
CM-25124	1-1/2 X 1/2	3.76
CM-375-9023-071	1-1/2 X 1/2	3.76
CM-391-2684-148	1-1/2 X 1/2	3.76
CM-25040	1-1/2 X 5/8	3.76
CM-375-9003-246	1-1/2 X 5/8	3.76
CM-25009	1-3/4 X 3/8	3.81
CM-25010	1-3/4 X 1/2	3.71
CM-391-2684-149	1-3/4 X 1/2	3.71
CM-25009	1-3/4 X 3/8	3.81
CM-25149	2 X 1/4	3.23
CM-25001	2 X 3/8	3.81
CM-25011	2 X 1/2	4.01
CM-375-9023-092	2 X 1/2	4.01
CM-391-2684-150	2 X 1/2	4.01
CM-25558	2 X 3/4	4.26
CM-25002	2-1/4 X 3/8	4.01
CM-25012	2-1/4 X 1/2	4.01
CM-375-9003-238	2-1/4 X 1/2	7.13
CM-391-2684-151	2-1/4 X 1/2	4.01
CM-25147	2-1/4 X 5/8	4.20
CM-25050	2-1/4 X 3/4	4.14
CM-375-9003-202	2-1/4 X 3/4	7.42
CM-391-2684-101	2-1/4 X 3/4	4.14
CM-25013	2-3/8 X 1/2	4.14
CM-25003	2-1/2 X 3/8	4.14
CM-25014	2-1/2 X 1/2	4.16
CM-375-9023-072	2-1/2 X 1/2	4.16
CM-391-2684-152	2-1/2 X 1/2	6.91
CM-2505025	2-1/2 X 3/4	4.96
CM-25072	2-3/4 X 1	20.25
CM-375-9023-142	2-3/4 X 1	22.44

## WEAR RINGS

Part Number	O.D. X Width	List Price
CM-25015	2-3/4 X 1/2	\$ 4.20
CM-375-9023-052	2-3/4 X 1/2	4.20
CM-375-9023-070	2-3/4 X 1/2	4.20
CM-375-9003-027	2-3/4 X 2	18.33
CM-25004	2-3/4 X 3/8	4.20
CM-250655	2-7/8 X 1	5.46
CM-25116	3 X 1	4.76
CM-25144	3 X 1/4	3.86
CM-25016	3 X 1/2	10.66
CM-250505	3 X 3/4	4.91
CM-25115	3 X 3/4	4.91
CM-391-2684-097	3 X 3/4	4.91
CM-25006	3-1/4 X 3/8	4.39
CM-25017	3-1/4 X 1/2	4.39
CM-375-9023-031	3-1/4 X 1/2	4.39
CM-391-2684-124	3-1/4 X 1/2	4.39
CM-391-2684-133	3-1/4 X 1/2	4.39
CM-25051	3-1/4 X 3/4	4.91
CM-391-2684-077	3-1/4 X 3/4	4.91
CM-25834	3-1/4 X 1	5.27
CM-375-9003-071	3-1/4 X 1	9.32
CM-375-9003-059	3-1/4 X 2	25.10
CM-375-9023-128	3-1/4 X 2-1/8	24.71
CM-25119	3-1/2 X 3/8	4.42
CM-25018	3-1/2 X 1/2	4.42
CM-375-9023-036	3-1/2 X 1/2	4.42
CM-375-9023-089	3-1/2 X 1/2	4.42
CM-25035	3-1/2 X 5/8	4.91
CM-25052	3-1/2 X 3/4	4.93
CM-375-9023-116	3-1/2 X 3/4	17.19
CM-391-2681-635	3-1/2 X 3/4	17.19
CM-391-2684-092	3-1/2 X 3/4	4.93
CM-25071	3-1/2 X 1	5.34
CM-25145	3-3/4 X 3/8	5.60
CM-25019	3-3/4 X 1/2	4.49
CM-375-9023-147	3-3/4 X 1/2	12.03
CM-391-2684-163	3-3/4 X 3/4	5.16
CM-375-9023-135	3-3/4 X 1.240	15.06
CM-25007	4 X 3/8	5.60
CM-25020	4 X 1/2	4.49
CM-391-2684-004	4 X 1/2	4.49
CM-391-2684-153	4 X 1/2	4.49
CM-25036	4 X 5/8	5.27

# REPLACEMENT PARTS FOR COMMERCIAL® EQUIPMENT

**NOTE:** Commercial part numbers are used as a reference only. We do not imply that these kits are original REPLACEMENT PARTS.

## WEAR RINGS

Part Number	O.D. X Width	List Price
CM-25053	4 X 3/4	\$ 4.93
CM-391-2684-080	4 X 3/4	4.93
CM-25065	4 X 1	5.76
CM-375-9023-088	4 X 1	5.76
CM-375-9023-149	4 X 1	28.50
CM-25021	4-1/4 X 1/2	4.62
CM-375-9003-257	4-1/4 X 1/2	4.62
CM-375-9023-021	4-1/4 X 1/2	4.62
CM-25037	4-1/4 X 5/8	5.27
CM-25135	4-1/4 X 3/4	5.46
CM-391-2684-118	4-1/4 X 3/4	5.46
CM-375-9023-027	4-1/4 X 7/8	24.04
CM-375-3023-031	4-1/4 X 1	7.05
CM-375-9003-036	4-1/4 X 1-1/4	12.56
CM-25066	4-1/2 X 1	7.05
CM-25022	4-1/2 X 1/2	4.72
CM-375-9023-032	4-1/2 X 1/2	4.72
CM-25038	4-1/2 X 5/8	5.27
CM-25054	4-1/2 X 3/4	5.15
CM-25121	4-3/4 X 1/2	4.72
CM-375-9023-033	4-3/4 X 1/2	4.72
CM-25123	4-3/4 X 1	7.11
CM-375-9003-216	4-3/4 X 1-1/4	13.14
CM-25847	4-3/4 X 2	34.99
CM-25023	5 X 1/2	4.72
CM-375-9023-034	5 X 1/2	4.72
CM-391-2684-142	5 X 1/2	4.72
CM-25055	5 X 3/4	5.27
CM-391-2684-121	5 X 3/4	5.27
CM-25039	5 X 0.622	5.27
CM-25067	5 X 1	7.11
CM-25118	5-1/4 X 1/2	4.72
CM-391-2684-125	5-1/4 X 1/2	4.72
CM-25143	5-1/4 X 5/8	5.27
CM-391-2684-082	5-1/4 X 3/4	5.37
CM-375-9023-141	5-1/4 X 1-1/4	14.15
CM-375-9023-134	5-1/4 X 2	38.20
CM-25554	5-1/2 X 1	7.19
CM-25024	5-1/2 X 1/2	4.72
CM-391-2684-145	5-1/2 X 1/2	4.72
CM-25056	5-1/2 X 3/4	5.37
CM-375-9023-090	5-1/2 X 3/4	5.37
CM-391-2684-155	5-1/2 X 3/4	5.37

## WEAR RINGS

Part Number	O.D. X Width	List Price
CM-25025	5-3/4 X 1/2	\$ 5.39
CM-25041	5-3/4 X 5/8	5.75
CM-375-9003-252	5-3/4 X 1-1/2	26.51
CM-375-9023-140	5-3/4 X 1-1/2	26.51

## WIPERS

Part Number	Rod Dia.	List Price
CM-14075	3/4	\$ 3.05
CM-391-3881-116	3/4	1.08
CM-12100	1	2.65
CM-391-3881-105	1	1.16
CM-12112	1-1/8	2.65
CM-12125	1-1/4	2.89
CM-391-3881-101	1-1/4	1.26
CM-375-3026-017	1-3/8	3.06
CM-12150	1-1/2	3.38
CM-14151	1-1/2	12.94
CM-391-3881-102	1-1/2	12.61
CM-391-3881-106	1-1/2	1.86
CM-12175	1-3/4	3.79
CM-13019	1-3/4	1.95
CM-375-9026-081	1-3/4	3.79
CM-391-3881-095	1-3/4	1.95
CM-391-3881-104	1-3/4	13.62
CM-12200	2	3.97
CM-375-9026-083	2	3.97
CM-375-9026-112	2	7.29
CM-391-3881-071	2	1.99
CM-12225	2-1/4	4.19
CM-391-3881-053	2-1/4	2.12
CM-391-3881-107	2-3/8	2.18
CM-12250	2-1/2	4.19
CM-375-9026-082	2-1/2	4.70
CM-391-3881-055	2-1/2	2.39
CM-391-3881-103	2-1/2	17.12
CM-12262	2-5/8	4.53
CM-12275	2-3/4	4.83
CM-375-9026-047	2-3/4	19.39
CM-391-3881-108	2-3/4	2.52
CM-12300	3	5.05
CM-375-9026-121	3	7.22

## WIPERS

Part Number	Rod Dia.	List Price
CM-375-9026-132	3	\$ 2.94
CM-391-3881-054	3-1/4	3.46
CM-12350	3-1/2	5.75
CM-391-3881-096	3-1/2	3.55
CM-391-3881-112	3-7/8	3.84
CM-12400	4	7.49
CM-375-9026-017	4	37.46
CM-375-9026-044	4	7.49
CM-375-9026-131	4	3.95
CM-391-3881-099	4	3.95
CM-391-3881-110	4-1/8	4.06
CM-375-9026-079	4-1/4	30.91
CM-391-3881-056	4-1/4	4.16
CM-12450	4-1/2	8.39
CM-12453-520	4-1/2	11.31
CM-375-9026-098	4-1/2	8.39
CM-375-9026-106	4-1/2	4.28
CM-375-9026-066	4-3/4	41.33
CM-375-9026-128	4-3/4	42.34
CM-12500	5	11.71
CM-375-9026-130	5	11.37
CM-391-3881-114	5	5.25
CM-375-9026-006	5-1/2	14.55
CM-391-3881-115	6	6.68
CM-391-3881-111	6-1/4	6.91
CM-391-3881-109	6-1/2	7.05
CM-391-3881-121	6-1/2	59.06
CM-375-9026-120	7	20.44
CM-375-9026-097	8-1/4	24.60

## BUFFER RINGS

Part Number	Rod Dia.	List Price
CM-260015	1-1/8	\$ 16.82
CM-375-9006-333	1-3/4	24.28
CM-26004	2	25.54
CM-375-9006-344	2	27.49
CM-26010	2-5/8	34.38
CM-375-9006-345	3	41.74
CM-26036	4	58.66
CM-375-9006-513	5	78.10
CM-375-9006-516	5	77.57
CM-375-9006-480	7	85.25





# REPLACEMENT PARTS FOR COMMERCIAL® EQUIPMENT

**NOTE:** Commercial part numbers are used as a reference only. We do not imply that these kits are original REPLACEMENT PARTS.

## O-RINGS

Part Number	Min. Pkgs.	List Price
CM-10016	50	\$ 0.07
CM-10022	50	0.10
CM-10113	50	0.07
CM-10116	50	0.09
CM-10120	50	0.10
CM-10128	20	0.22
CM-10129	20	0.22
CM-10153	20	0.63
CM-10218	50	0.19
CM-10222	20	0.25
CM-10224	20	0.52
CM-10228	20	0.41
CM-10230	20	0.48
CM-10232	20	0.51
CM-10232U	2	11.38
CM-10236	20	0.63
CM-10242	10	0.76
CM-10246	10	1.08
CM-10252	10	1.25
CM-10254	5	1.46
CM-10322	20	0.28
CM-10326	20	0.31
CM-10330	20	0.54
CM-10334	20	0.70
CM-10336	10	0.82
CM-10338	10	0.85
CM-10339	10	0.95
CM-10342	10	1.11
CM-10343	10	1.14
CM-10346	10	1.25
CM-10347	10	1.25
CM-10350	5	1.46
CM-10351	5	1.46
CM-10354	5	1.70
CM-10355	5	1.89
CM-10358	5	2.09
CM-10359	5	2.09
CM-10364	5	2.54
CM-10368	5	2.65
CM-10425	5	1.58

## O-RINGS

Part Number	Min. Pkgs.	List Price
CM-10429	5	\$ 1.78
CM-10433	5	2.06
CM-10439	5	2.65
CM-10443	1	3.28
CM-10448	1	3.92
CM-10450	1	4.74
CM-30337	10	1.25
CM-30345	7	1.43
CM-30349	6	1.68
CM-30427	3	2.69
CM-30431	3	2.69
CM-30434	3	2.73
CM-375-2881-025	1	4.07
CM-375-2881-033	5	3.71
CM-375-2881-038	10	1.25
CM-375-2881-039	5	2.96
CM-375-2881-043	1	2.95
CM-375-2881-044	5	2.58
CM-375-2881-047	1	4.19
CM-375-2881-048	5	1.25
CM-375-2881-051	5	1.70
CM-375-2881-052	5	1.95
CM-375-2881-056	1	4.43
CM-375-2884-002	5	1.60
CM-391-2811-371	10	1.93
CM-391-2881-001	30	0.35
CM-391-2881-002	30	0.35
CM-391-2881-003	20	0.40
CM-391-2881-004	20	0.40
CM-391-2881-005	20	0.46
CM-391-2881-006	15	0.51
CM-391-2881-007	15	0.55
CM-391-2881-008	15	0.64
CM-391-2881-009	15	0.64
CM-391-2881-010	15	0.64
CM-391-2881-012	10	0.74
CM-391-2881-013	10	0.78
CM-391-2881-014	10	0.83
CM-391-2881-015	10	0.85
CM-391-2881-016	5	1.31

## O-RINGS

Part Number	Min. Pkgs.	List Price
CM-391-2881-017	5	\$ 1.59
CM-391-2881-018	5	1.68
CM-391-2881-019	4	1.82
CM-391-2881-020	3	1.82
CM-391-2881-021	4	2.07
CM-391-2881-022	2	2.87
CM-391-2881-023	5	1.18
CM-391-2881-024	5	1.25
CM-391-2881-025	5	1.38
CM-391-2881-027	10	0.87
CM-391-2881-028	4	1.59
CM-391-2881-029	5	1.68
CM-391-2881-030	3	1.68
CM-391-2881-031	3	1.82
CM-391-2881-032	3	1.93
CM-391-2881-033	3	2.05
CM-391-2881-034	3	2.25
CM-391-2881-035	3	2.38
CM-391-2881-036	3	2.63
CM-391-2881-037	3	2.85
CM-391-2881-038	3	3.20
CM-391-2881-039	3	3.52
CM-391-2881-040	2	3.73
CM-391-2881-041	2	3.91
CM-391-2881-042	2	4.26
CM-391-2881-043	2	5.20
CM-391-2881-044	2	5.41
CM-391-2881-046	1	6.75
CM-391-2881-048	1	7.59
CM-391-2881-049	1	7.95
CM-391-2881-050	1	8.42
CM-391-2881-051	1	9.37
CM-391-2881-052	1	10.29
CM-391-2881-053	1	11.49
CM-391-2881-054	1	12.76
CM-391-2881-055	1	14.05
CM-391-2881-056	1	19.26
CM-391-2881-095	50	0.33
CM-391-2881-096	50	0.19
CM-391-2881-100	20	0.25

COMMERCIAL® HYDRAULICS



# REPLACEMENT PARTS FOR COMMERCIAL® EQUIPMENT

**NOTE:** Commercial part numbers are used as a reference only. We do not imply that these kits are original REPLACEMENT PARTS.

COMMERCIAL® HYDRAULICS

## O-RINGS

Part Number	Min. Pkgs.	List Price
CM-391-2881-102	50	\$ 0.18
CM-391-2881-113	20	0.67
CM-391-2881-114	10	0.76
CM-391-2881-117	10	1.25
CM-391-2881-124	20	0.31
CM-391-2881-140	50	0.19
CM-391-2881-142	20	0.52
CM-391-2881-146	10	1.21
CM-391-2881-153	5	1.58
CM-391-2881-154	10	1.08
CM-391-2881-165	5	2.09
CM-391-2881-167	10	0.82
CM-391-2881-172	20	0.22
CM-391-2881-187	1	3.60
CM-391-2881-189	1	3.92
CM-391-2881-197	50	0.24
CM-391-2881-215	50	0.18
CM-391-2881-230	5	2.03
CM-391-2881-232	20	0.70
CM-391-2881-237	20	0.70
CM-391-2881-263	1	14.05
CM-391-2881-280	5	2.54
CM-391-2881-321	50	0.10
CM-391-2881-322	50	0.10
CM-391-2881-323	50	0.10
CM-391-2881-324	50	0.10
CM-391-2881-325	50	0.10
CM-391-2881-326	50	0.10
CM-391-2881-327	50	0.11
CM-391-2881-328	50	0.11
CM-391-2881-329	50	0.14
CM-391-2881-330	50	0.14
CM-391-2881-331	50	0.14
CM-391-2881-332	50	0.14
CM-391-2881-333	50	0.15
CM-391-2881-334	50	0.26
CM-391-2881-335	50	0.26
CM-391-2881-336	50	0.28
CM-391-2881-337	50	0.29
CM-391-2881-338	50	0.29

## O-RINGS

Part Number	Min. Pkgs.	List Price
CM-391-2881-339	50	\$ 0.33
CM-391-2881-340	50	0.33
CM-391-2881-342	20	0.40
CM-391-2881-343	20	0.42
CM-391-2881-344	20	0.45
CM-391-2881-345	20	0.45
CM-391-2881-346	20	0.51
CM-391-2881-347	20	0.66
CM-391-2881-348	20	0.66
CM-391-2881-349	20	0.70
CM-391-2881-350	20	0.74
CM-391-2881-351	20	0.89
CM-391-2881-352	20	0.95
CM-391-2881-353	10	0.99
CM-391-2881-356	10	1.23
CM-391-2881-357	10	1.34
CM-391-2881-358	10	1.40
CM-391-2881-359	10	1.45
CM-391-2881-360	10	1.59
CM-391-2881-361	10	1.68
CM-391-2881-362	50	0.11
CM-391-2881-363	50	0.11
CM-391-2881-364	5	3.17
CM-391-2881-365	1	3.88
CM-391-2881-366	1	6.23
CM-391-2881-367	1	7.13
CM-391-2881-368	10	1.40
CM-391-2881-369	10	1.45
CM-391-2881-370	5	1.96
CM-391-2881-372	5	3.02
CM-391-2881-373	5	3.73
CM-391-2881-374	1	4.75
CM-391-2881-379	1	4.79
CM-391-2881-380	1	5.23
CM-391-2881-381	1	5.52
CM-391-2881-382	1	5.87
CM-391-2881-383	1	6.11
CM-391-2881-384	1	8.09
CM-391-2881-386	1	14.72
CM-391-2881-387	1	15.24

## O-RINGS

Part Number	Min. Pkgs.	List Price
CM-391-2881-394	3	\$ 3.13
CM-391-2881-406	1	6.83
CM-391-2881-407	5	2.24
CM-391-2881-410	1	14.32
CM-391-2881-411	10	1.82
CM-391-2881-425	1	8.80
CM-391-2881-443	50	0.21
CM-391-2881-451	20	0.74
CM-391-2881-452	1	11.29
CM-391-2881-454	50	0.10
CM-391-2881-474	1	18.57
CM-391-2881-475	1	20.72
CM-391-2881-476	20	0.66
CM-391-2881-480	20	0.37
CM-391-2881-481	10	0.92
CM-391-2881-486	5	1.39
CM-391-2881-487	2	2.65
CM-391-2881-498	20	0.40
CM-391-2881-499	20	0.48
CM-391-2881-601	2	4.77
CM-391-2881-602	2	5.83
CM-391-2881-603	10	0.85
CM-391-2881-610	5	1.42
CM-391-2881-612	3	1.89
CM-391-2881-620	2	3.34
CM-391-2881-632	50	0.21
CM-391-2881-634	50	0.12
CM-391-2881-649	10	0.95
CM-391-2881-699	2	4.47
CM-391-2881-700	1	7.48
CM-391-2881-701	1	30.43
CM-391-2881-702	1	39.97
CM-391-2881-705	5	3.32
CM-391-2881-708	2	3.38
CM-391-2881-714	1	20.38
CM-391-2881-715	1	25.07
CM-391-2881-716	1	13.14
CM-391-2881-719	40	0.35
CM-391-2881-726	1	6.94
CM-391-2881-728	10	0.99

# REPLACEMENT PARTS FOR COMMERCIAL® EQUIPMENT

**NOTE:** Commercial part numbers are used as a reference only. We do not imply that these kits are original REPLACEMENT PARTS.

## O-RINGS

Part Number	Min. Pkgs.	List Price
CM-391-2881-731	1	\$ 4.46
CM-391-2881-732	10	1.36
CM-391-2881-733	1	7.00
CM-391-2881-734	1	7.74
CM-391-2881-735	20	0.62
CM-391-2881-760	5	2.32
CM-391-2881-761	10	1.15
CM-391-2881-762	1	4.43
CM-391-2881-763	20	0.80
CM-391-2881-764	5	2.07
CM-391-2881-765	20	0.66
CM-391-2881-766	10	1.91
CM-391-2881-772	10	1.00
CM-391-2881-777	10	1.18
CM-391-2881-783	20	0.74
CM-391-2881-785	50	0.25
CM-391-2881-792	50	0.14
CM-391-2881-793	50	0.11
CM-391-2881-795	50	0.25
CM-391-2881-796	50	0.25
CM-391-2881-822	50	0.09
CM-391-2881-839	50	0.12
CM-391-2882-230	10	1.73
CM-391-2882-236	50	0.12
CM-391-2882-328	20	0.63
CM-391-2884-003	12	0.74
CM-391-2884-029	3	3.41

## BACK-UP RINGS

Part Number	Min. Pkgs.	List Price
CM-11218	10	\$ 0.86
CM-11224	10	0.93
CM-11228	10	0.99
CM-11232	10	1.12
CM-11236	10	1.23
CM-11252	1	3.25
CM-11322	10	0.86

## BACK-UP RINGS

Part Number	Min. Pkgs.	List Price
CM-11326	10	\$ 0.99
CM-11330	10	0.99
CM-11334	10	1.04
CM-11336	10	1.12
CM-11338	10	1.20
CM-11339	10	1.27
CM-11342	5	1.47
CM-11343	5	1.65
CM-11346	5	2.16
CM-11347	5	2.26
CM-11350	5	2.55
CM-11351	1	2.86
CM-11354	1	3.07
CM-11355	1	3.25
CM-11358	1	3.69
CM-11359	1	3.89
CM-11364	1	4.35
CM-11368	1	4.35
CM-11425	3	2.55
CM-11429	1	3.31
CM-11433	1	3.70
CM-11439	1	4.32
CM-11443	1	6.06
CM-11448	1	10.98
CM-11450	1	11.91
CM-375-2681-031	1	4.78
CM-375-2681-041	10	1.25
CM-375-2681-042	5	3.12
CM-375-2681-049	1	3.76
CM-375-2681-050	5	2.64
CM-375-2681-056	1	4.88
CM-375-2681-063	5	1.64
CM-391-2681-016	25	0.33
CM-391-2681-040	1	4.76
CM-391-2681-041	10	1.25
CM-391-2681-064	1	3.38
CM-391-2681-068	1	4.31
CM-391-2681-070	1	4.35
CM-391-2681-074	1	5.72

## BACK-UP RINGS

Part Number	Min. Pkgs.	List Price
CM-391-2681-075	1	\$ 5.77
CM-391-2681-081	1	6.93
CM-391-2681-090	1	7.43
CM-391-2681-261	1	4.37
CM-391-2681-303	10	0.46
CM-391-2681-320	10	0.53
CM-391-2681-326	10	0.71
CM-391-2681-330	5	1.74
CM-391-2681-331	5	2.23
CM-391-2681-354	5	2.15
CM-391-2681-389	1	6.97
CM-391-2681-409	25	0.42
CM-391-2681-410	25	0.45
CM-391-2681-413	5	1.63
CM-391-2681-419	1	4.37
CM-391-2681-420	5	2.14
CM-391-2681-436	10	0.93
CM-391-2681-450	10	1.44
CM-391-2681-551	1	6.99
CM-391-2681-572	5	1.99
CM-391-2681-574	25	0.40
CM-391-2681-576	5	1.86
CM-391-2681-578	10	1.44
CM-391-2681-639	25	0.46
CM-391-2691-001	10	0.60
CM-391-2691-002	10	0.65
CM-391-2691-008	10	0.96
CM-391-2691-016	10	1.44
CM-391-2691-028	5	2.70
CM-391-2691-034	1	3.58
CM-391-2691-040	1	4.76
CM-391-2691-043	1	5.81
CM-391-2881-450	10	1.44

## RETAINER RINGS

Part Number	List Price
CM-375-2685-002	\$ 7.97
CM-375-2686-009	5.67

COMMERCIAL® HYDRAULICS

## CROSS

Kit Number	Code (Pg. xviii)	Rod X Bore Size	List Price
CR-1C 1480	P-U-5	1-1/16 X 2	\$ 27.60
CR-1C 4147	P-OB-3	1-1/8 X 3	12.46
CR-1C 4244	P-OB-3	1-1/16 X 2	15.69
CR-1C 4429	P-OB-3	1-1/4 X 3-1/2	14.11
CR-1C 4430	P-OB-3	1-1/4 X 4	14.77
CR-1C 4433	P-OB-3	1-1/16 X 2-1/2	16.34
CR-1C 4629	P-OB-3	1-1/4 X 3	10.73
CR-1C 4630	P-OB-3	1-1/2 X 3	10.97
CR-1C 4631	P-OB-3	1-1/2 X 3-1/2	14.47
CR-1C 4637	P-OB-3	1-1/2 X 4	20.76
CR-1C 4638	P-OB-3	2 X 4	14.58
CR-1C 4642	P-OB-3	3/4 X 1-1/2	18.34
CR-1C 4750	P-OB-3	1 X 2	10.97
CR-1C 4759	P-OB-3	1-1/4 X 2-1/2	11.29
CR-1C 4765	P-OB-3	1-1/4 X 3	11.39
CR-1C 4785	P-OB-3	1-1/2 X 4	15.51
CR-1C 4786-A	P-OB-3	2 X 4	13.36
CR-1C 4796	P-OB-3	2-1/2 X 5	20.76
CR-1C 9964	P-U-5	2 X 4	54.55
CR-2C 1955	P-U-5	1-1/2 X 4	54.28
CR-2C 2842	P-OB-3	1-1/4 X 3	16.21
CR-2C 5395	P-U-5	3-1/2 X 6	88.86
CR-3C 2597	P-U-5	1-1/2 X 3	34.39
CR-3C 7684	P-OB-3	1-3/4 X 4	22.88

## CROWN LIFT TRUCKS

Kit Number	Code (Pg. xviii)	Rod X Bore Size	List Price
CRN-087484		O-RING	\$ 4.20
CRN-088719		O-RING	3.76
CRN-089178	I-U-13	1-3/4 X 3-1/2	51.08
CRN-093217		O-RING	4.03
CRN-101296	I-U-1	2-1/2" Rod Kit	21.70
CRN-101301	I-U-1	2 ROD KIT	25.68
CRN-101302	I-U-1	1-7/8 X 2-1/2	67.74
CRN-101305	I-U-1	1-5/8 X Rod Kit	99.42
CRN-101309	I-U-1	1-7/8" ROD KIT	71.07
CRN-101310	I-U-1	2-1/2" ROD KIT	28.89
CRN-101313	I-U-1	1-3/8" Rod Kit	26.09
CRN-101314	I-U-1	2-1/8" ROD KIT	20.15
CRN-101316	I-U-1	2-3/8" ROD KIT	47.05

## CROWN LIFT TRUCKS

Kit Number	Code (Pg. xviii)	Rod X Bore Size	List Price
CRN-101323	I-V-1	1-7/8" Rod Kit	\$ 69.00
CRN-101326	I-U-1	2-3/8" Rod Kit	31.95
CRN-101329	I-U-1	1-7/8, 2-5/8 Stages	79.50
CRN-101331	I-U-1	1-3/4, 2-3/8 Stages	63.76
CRN-101332	I-U-1	1-3/4 X 2-1/2	21.27
CRN-101334	I-U-1	1-7/8, 2-5/8 Rod kit	80.19
CRN-101335	I-U-N	1-5/8, 2-1/4 Stages	69.11
CRN-101336	I-U-1	1-5/8, 2-1/4 Stages	71.52
CRN-101339	I-U-1	2" Rod Kit	79.06
CRN-101340	I-U-1	1-7/8 ROD KIT	21.71
CRN-101341	I-U-5	1-1/4 X 2-3/8	53.10
CRN-101342	I-U-3	1-1/2 X 3	70.12
CRN-101343	1-U-5	3/4 X 2	61.92
CRN-101346	I-U-5	3/4 X 1-3/4	44.26
CRN-101347	I-U-5	3/4 X 2-1/8	61.01
CRN-101376	I-U-5	1-1/4 X 3	84.57
CRN-101377	I-U-5	1 x 1-3/4	45.63
CRN-102659		VALVE KIT	4.94
CRN-105476004		O-RING	7.40
CRN-105476-6		O-RING	2.47
CRN-107366	I-O-1	1/2" Valve Kit	18.00
CRN-111573	I-U-1	3" ROD KIT	35.74
CRN-111574	I-U-1	2" ROD KIT	22.92
CRN-111790-001		O-RING	2.47
CRN-111790-12		O-RING	2.47
CRN-111790-2		O-RING	4.94
CRN-111790-3		O-RING	3.11
CRN-111790-4		O-RING	3.11
CRN-111790-9		O-RING	2.93
CRN-112022	I-U-4	7/8 X 2	22.16
CRN-112704		8, 9/16" Spools Rod Kit	19.16
CRN-113744	I-U-13	2-1/2 X 3-1/4	57.42
CRN-113745	I-U-13	3/4 x 1-3/4	28.48
CRN-115604	I-U-4	7/8 X 2	35.33
CRN-116360	N-O-1	O-RING	5.47
CRN-116820	I-U-1	2" rod kit	15.84
CRN-42249	I-U-1	56 X 80 mm	38.45
CRN-43023-1		VALVE KIT	31.61
CRN-78685		VALVE KIT	14.70
CRN-79017		VALVE KIT	4.53
CRN-87317	N-O-1	O-RING	4.03
CRN-89704	I-U-13	1-3/4 x 2-3/4	71.53
CRN-90880	I-U-5	3/4 X 1-3/4	45.98
CRN-94580	I-O-1	5/8" Rod kit	5.37

# CUSTOM HOISTS® 700 SERIES

- PACKING:** Vee packing with nylon top and bottom adapters.  
**WIPERS:** An improved dual-lip snap in wiper to minimize contamination entry.  
**Bearing:** Top mineral filled nylon bearing.  
**Retainer Ring:** Heavy duty for improved strength.  
**Plunger Stop:** Beveled plunger stop for plunger center.  
**Piston Wear Ring:** Wear ring with increased cross-section for added strength.  
**Stage O.D.:** 3-3/16", 4-1/8", 5-1/16" & 6"  
**Identification:** Part number and serial number stamped in body near base of cylinder. Ex. 63-702-120

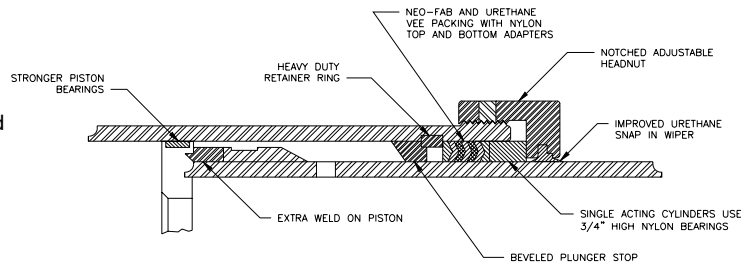

Part Number	Description	List Price
<b>SEAL KITS</b>		
CH-SK-53-700	3 - 5" Seal Kit	\$ 109.74
CH-SK-63-700	4 - 6" Seal Kit	125.58
CH-SK-64-700	3 - 6" Seal Kit	154.86
CH-SK-74-700	4 - 7" Seal Kit	226.59
<b>MINOR PACKING KITS</b>		
CH-MPK-53-700	3 - 5" Minor Packing Kit	\$ 192.52
CH-MPK-63-700	4 - 6" Minor Packing Kit	210.39
CH-MPK-64-700	3 - 6" Minor Packing Kit	265.19
CH-MPK-74-700	4 - 7" Minor Packing Kit	400.45
<b>MAJOR PACKING KITS</b>		
CH-MRK-53-700	3 - 5" Major Repair Kit	\$ 601.39
CH-MRK-63-700	4 - 6" Major Repair Kit	648.00
CH-MRK-64-700	3 - 6" Major Repair Kit	809.47
CH-MRK-74-700	4 - 7" Major Repair Kit	970.59
<b>NYLON TOP BEARINGS</b>		
CH-1BU11-3-3/16	3-3/16" Nylon Top Bearing	\$ 19.15
CH-1BU11-4-1/8	4-1/8" Nylon Top Bearing	19.75
CH-1BU11-5-1/16	5-1/16" Nylon Top Bearing	19.86
CH-1BU11-6	6" Nylon Top Bearing	15.82
CH-1BU11-7	7" Nylon Top Bearing	17.22
<b>PACKINGS</b>		
CH-700-3-3/16VS	3-3/16" Vee Set	\$ 23.17
CH-700-4-1/8VS	4-1/8" Vee Set	26.91
CH-700-5-1/16VS	5-1/16" Vee Set	33.40
CH-700-6VS	6" Vee Set	26.20
CH-PK-1-7	7" Vee Set	32.66

Part Number	Description	List Price
<b>WIPERS</b>		
CH-1WR1-3-3/16	3-3/16" Wiper	\$ 7.91
CH-1WR1-4-1/8	4-1/8" Wiper	10.28
CH-1WR1-5-1/16	5-1/16" Wiper	12.69
CH-1WR1-6	6" Wiper	10.65
CH-1WR1-7	7" Wiper	13.17
<b>RETAINER RINGS</b>		
CH-2RR58-368	3-11/16" Retainer Ring	\$ 45.06
CH-2RR58-462	4-5/8" Retainer Ring	45.06
CH-2RR58-550	5-1/2" Retainer Ring	47.30
CH-2RR58-650	6-1/2" Retainer Ring	44.83
CH-2RR58-750	7" Retainer Ring	54.72
<b>PLUNGER STOP</b>		
CH-2PS44-3-3/16	3-3/16" Plunger Stop	\$ 63.15
CH-2PS44-4-1/8	4-1/8" Plunger Stop	64.71
CH-2PS44-5-1/16	5-1/16" Plunger Stop	68.05
CH-2PS44-6	6" Plunger Stop	68.44
CH-2PS36-7	7" Plunger Stop	79.00
<b>PISTON WEAR RINGS</b>		
CH-2WG3-3-3/16	3-3/16" Piston Wear Ring	\$ 4.81
CH-2WG3-4-1/8	4-1/8" Piston Wear Ring	6.05
CH-2WG3-5-1/16	5-1/16" Piston Wear Ring	7.12
CH-2WG3-6	6" Piston Wear Ring	8.60
CH-2WG1-7	7" Piston Wear Ring	7.32
<b>WAVE SPRING</b>		
CH-1WA11-7	7" Wave Spring	\$ 34.22
<b>BUSHING</b>		
CH-1BU195-7	7" Bushing	\$ 21.71



# CUSTOM HOISTS® 400 SERIES

- PACKING:** Vee packing with nylon top and bottom adapters.  
**WIPERS:** An improved dual-lip snap in wiper to minimize contamination entry.  
**WAVE SPRING:** To apply a continuous force on the packing.  
**BEARINGS:** Top and bottom mineral filled nylon bearing.  
**RETAINER RING:** Heavy duty for improved strength.  
**PLUNGER STOP:** Beveled plunger stop for plunger centering.  
**PISTON WEAR RING:** Wear ring with increased cross-section for added strength.  
**STAGE O.D.'S:** 3, 4, 5, 6, 7, 8, 8-1/4, 9-1/8, 9-3/4  
**IDENTIFICATION:** Part number and serial number stamped in body near oil port near base of cylinder.  
 Example: 85-402-250 single acting.

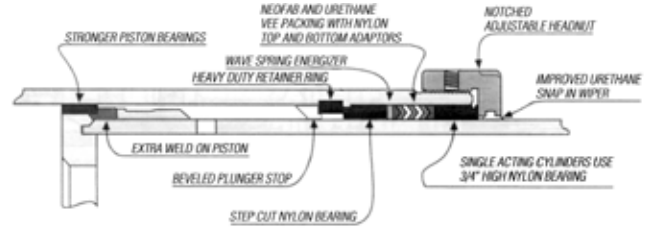

CUSTOM HOISTS®

Part Number	Description	List Price
<b>SEAL KITS</b>		
CH-SK-53-400	3 - 5" Seal Kit	\$ 143.19
CH-SK-63-400	4 - 6" Seal Kit	172.31
CH-SK-64-400	3 - 6" Seal Kit	215.33
CH-SK-73-400	5 - 7" Seal Kit	225.94
CH-SK-74-400	4 - 7" Seal Kit	269.68
CH-SK-8-1/4 5-400	4 - 8-1/4" Seal Kit	467.06
CH-SK-84-400	5 - 8" Seal Kit	337.97
CH-SK-85-400	4 - 8" Seal Kit	382.13
CH-SK-95-400	5 - 9-1/8" Seal Kit	529.64
<b>MINOR PACKING KITS</b>		
CH-MPK-53-400	3 - 5" Minor Packing Kit	\$ 235.41
CH-MPK-63-400	4 - 6" Minor Packing Kit	269.87
CH-MPK-64-400	3 - 6" Minor Packing Kit	342.45
CH-MPK-73-400	5 - 7" Minor Packing Kit	332.03
CH-MPK-74-400	4 - 7" Minor Packing Kit	405.75
CH-MPK-8-1/4 5-400	4 - 8-1/4" Minor Packing Kit	722.89
CH-MPK-84-400	5 - 8" Minor Packing Kit	521.13
CH-MPK-85-400	4 - 8" Minor Packing Kit	561.50
CH-MPK-95-400	5 - 9" Minor Packing Kit	1099.59
<b>MAJOR REPAIR KITS</b>		
CH-MRK-53-400	3 - 5" Major Repair Kit	\$ 705.61
CH-MRK-63-400	4 - 6" Major Repair Kit	740.37
CH-MRK-64-400	3 - 6" Major Repair Kit	969.12
CH-MRK-73-400	5 - 7" Major Repair Kit	798.10
CH-MRK-74-400	4 - 7" Major Repair Kit	1032.93
CH-MRK-8-1/4 5-400	4 - 8" Major Repair Kit	2020.51
CH-MRK-84-400	5 - 8" Major Repair Kit	1168.69
CH-MRK-85-400	4 - 8" Major Repair Kit	1404.02
CH-MRK-95-400	5 - 9" Major Repair Kit	2205.19
<b>PACKING &amp; WIPERS</b>		
CH-400-3VSW	3" Vee Set & Wiper	\$ 19.78
CH-400-4VSW	4" Vee Set & Wiper	28.09
CH-400-5VSW	5" Vee Set & Wiper	33.84
CH-400-6VSW	6" Vee Set & Wiper	41.95
CH-400-7VSW	7" Vee Set & Wiper	50.07
CH-400-8.25VSW	8-1/4" Vee Set & Wiper	139.51
CH-400-8VSW	8" Vee Set & Wiper	61.07
CH-400-9.12VSW	9-1/8" Vee Set & Wiper	173.57
<b>NYLON BOTTOM BEARINGS</b>		
CH-1BU195-3	3" Nylon Bottom Bearing	\$ 15.92
CH-1BU195-4	4" Nylon Bottom Bearing	16.35
CH-1BU195-5	5" Nylon Bottom Bearing	17.80
CH-1BU195-6	6" Nylon Bottom Bearing	19.15
CH-1BU195-7	7" Nylon Bottom Bearing	21.71
CH-1BU195-8	8" Nylon Bottom Bearing	25.45
CH-1BU195-825	8-1/4" Nylon Bottom Bearing	59.43
CH-1BU195-91	9-1/8" Nylon Bottom Bearing	38.79
<b>NYLON TOP BEARINGS</b>		
CH-1BU11-3	3" Nylon Top Bearing	\$ 12.70
CH-1BU11-4	4" Nylon Top Bearing	12.70

Part Number	Description	List Price
<b>NYLON TOP BEARINGS</b>		
CH-1BU11-5	5" Nylon Top Bearing	\$ 13.38
CH-1BU11-6	6" Nylon Top Bearing	15.82
CH-1BU11-7	7" Nylon Top Bearing	17.22
CH-1BU11-8	8" Nylon Top Bearing	20.86
CH-1BU11-82	8-1/4" Nylon Top Bearing	39.52
CH-1BU11-91	9-1/8" Nylon Top Bearing	70.58
<b>RETAINER RINGS</b>		
CH-2RR58-350	3-1/2" Retainer Ring	\$ 50.98
CH-2RR58-450	4-1/2" Retainer Ring	49.82
CH-2RR58-550	5-1/2" Retainer Ring	47.30
CH-2RR58-650	6-1/2" Retainer Ring	44.83
CH-2RR58-750	7-1/2" Retainer Ring	54.72
CH-2RR58-850	8-1/2" Retainer Ring	70.96
CH-2RR58-9	9" Retainer Ring	209.22
CH-2RR58-975	9-3/4" Retainer Ring	150.54
<b>WAVE SPRINGS</b>		
CH-1WA11-3	3" Wave Spring	\$ 14.86
CH-1WA11-4	4" Wave Spring	16.10
CH-1WA11-5	5" Wave Spring	17.87
CH-1WA11-6	6" Wave Spring	21.09
CH-1WA11-7	7" Wave Spring	34.22
CH-1WA11-8	8" Wave Spring	36.76
CH-1WA11-825	8-1/4" Wave Spring	38.82
CH-1WA11-91	9-1/8" Wave Spring	41.51
<b>PLUNGER STOPS</b>		
CH-2PS36-3	3" Plunger Stop	\$ 73.39
CH-2PS36-4	4" Plunger Stop	74.79
CH-2PS36-5	5" Plunger Stop	75.01
CH-2PS36-6	6" Plunger Stop	77.59
CH-2PS36-7	7" Plunger Stop	79.00
CH-2PS36-8	8" Plunger Stop	98.43
CH-2PS36-825	8-1/4" Plunger Stop	116.72
CH-2PS36-91	9-1/8" Plunger Stop	193.67
<b>PISTON WEAR RINGS</b>		
CH-2WG1-3	3" Piston Wear Ring	\$ 4.96
CH-2WG1-4	4" Piston Wear Ring	10.02
CH-2WG1-5	5" Piston Wear Ring	5.43
CH-2WG1-8	8" Piston Wear Ring	13.24
CH-2WG1-6	6" Piston Wear Ring	6.13
CH-2WG1-7	7" Piston Wear Ring	7.32
CH-2WG1-91	9-1/8" Piston Wear Ring	21.72
<b>WIPERS</b>		
CH-1WR1-3	3" WIPER	\$ 6.28
CH-1WR1-4	4" WIPER	7.51
CH-1WR1-5	5" WIPER	9.04
CH-1WR1-6	6" WIPER	10.65
CH-1WR1-7	7" WIPER	13.17
CH-1WR1-8	8" WIPER	15.56
CH-1WR1-825	8-1/4" WIPER	22.10
CH-1WR1-91	9.12" WIPER	32.00

# CUSTOM HOISTS® TELESCOPICS

- PACKING:** Vee packing with nylon top and bottom adaptors.  
4" thru 8" all 1/4" c.s.
- WIPERS:** Snap in.
- BEARINGS:** One bronze or mineral filled nylon bearing above the packing.
- PISTON:** Steel pistons welded to stage. Replaceable "T" shaped nylon wear rings. Double action use 2 cast iron piston rings in separate grooves.
- STAGE O.D.'s:** 3, 4, 5, 6, 7, 8, 8-1/4, 9-1/8, 9-3/4
- SPECIAL INFO.:** Uses 2 spiral retainer rings with metal spacer in between.
- IDENTIFICATION:** Part number and serial number stamped in body near oil port near base of cylinder.  
Example: 85-2-220 single acting;  
DAT73-4-128 double acting

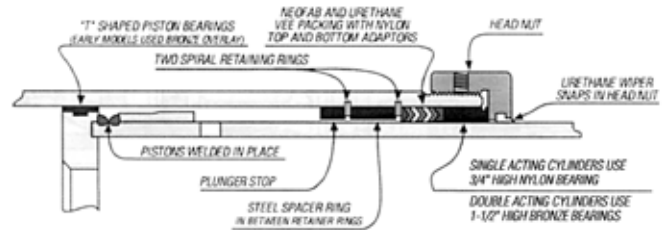

Part Number	Description	List Price
<b>PACKING &amp; WIPERS</b>		
CH-3VSW	3" Vee Set & Wiper	\$ 18.16
CH-4VSW	4" Vee Set & Wiper	20.18
CH-5VSW	5" Vee Set & Wiper	27.88
CH-6VSW	6" Vee Set & Wiper	33.98
CH-7VSW	7" Vee Set & Wiper	39.69
CH-8.25VSW	8-1/4" Vee Set & Wiper	102.19
CH-8VSW	8" Vee Set & Wiper	44.69
CH-9.12VSW	9-1/8" Vee Set & Wiper	147.65
CH-9.75VSW	9-3/4" Vee Set & Wiper	220.92
<b>NYLON TOP BEARINGS</b>		
CH-1BU11-3	3" Nylon Top Bearing	\$ 12.70
CH-1BU11-4	4" Nylon Top Bearing	12.70
CH-1BU11-5	5" Nylon Top Bearing	13.38
CH-1BU11-6	6" Nylon Top Bearing	15.82
CH-1BU11-7	7" Nylon Top Bearing	17.22
CH-1BU11-8	8" Nylon Top Bearing	20.86
CH-1BU11-82	8-1/4" Nylon Top Bearing	39.52
CH-1BU11-91	9-1/8" Nylon Top Bearing	70.58
CH-1BU1291/8	9-1/8" Nylon Top Bearing 1-1/2" Tall	88.84
<b>BRONZE TOP BEARINGS</b>		
CH-1BU3-3	3" X 3-1/2" X 1-1/2" Bronze Top Bearing	\$ 68.14
CH-1BU3-4	4" X 4-1/2" X 1-1/2" Bronze Top Bearing	94.44
CH-1BU3-5	5" X 5-1/2" X 1-1/2" Bronze Top Bearing	100.60
CH-1BU3-587	5-7/8" X 6-3/8" X 1-1/2" Bronze Top Bearing	97.38
CH-1BU3-6	6" X 6-1/2" X 1-1/2" Bronze Top Bearing	111.48
CH-1BU3-7	7" X 7-1/2" X 1-1/2" Bronze Top Bearing	128.16
CH-1BU3-8	8" X 8-1/2" X 1-1/2" Bronze Top Bearing	146.68
CH-1BU3-825	8-1/4" X 9" X 1-1/2" Bronze Top Bearing	146.21
<b>SPIRAL RETAINER RINGS</b>		
CH-1RR1-35	3-1/2" Bore Spiral Retainer Ring	\$ 4.15
CH-1RR1-45	4-1/2" Bore Spiral Retainer Ring	9.88
CH-1RR1-55	5-1/2" Bore Spiral Retainer Ring	10.11
CH-1RR1-637	6-3/8" Bore Spiral Retainer Ring	69.83
CH-1RR1-65	6-1/2" Bore Spiral Retainer Ring	7.83
CH-1RR1-75	7-1/2" Bore Spiral Retainer Ring	10.37
CH-1RR1-85	8-1/2" Bore Spiral Retainer Ring	12.85
CH-1RR1-9	9" Bore Spiral Retainer Ring	72.19
CH-1RR1-97	9-3/4" Bore Spiral Retainer Ring	82.22
CH-1RR1-105	10-1/2" Bore Spiral Retainer Ring	108.14

Part Number	Description	List Price
<b>SPACER RINGS</b>		
CH-2SP1-3	3" Spacer	\$ 26.22
CH-2SP1-4	4" Spacer	47.70
CH-2SP1-5	5" Spacer	45.67
CH-2SP1-5-7/8	5-7/8" Spacer	92.14
CH-2SP1-6	6" Spacer	51.26
CH-2SP1-7	7" Spacer	63.79
CH-2SP1-8	8" Spacer	79.44
CH-2SP1-8.25	8-1/4" Spacer	355.80
<b>T-SHAPED PISTON WEAR RINGS</b>		
CH-2GR6-3	3" Piston Wear Ring	\$ 7.60
CH-2GR6-4	4" Piston Wear Ring	8.19
CH-2GR6-5	5" Piston Wear Ring	10.46
CH-2GR6-6	6" Piston Wear Ring	12.96
CH-2GR6-7	7" Piston Wear Ring	14.10
CH-2GR6-8	8" Piston Wear Ring	23.26
CH-2GR6-825	8-1/4" Piston Wear Ring	33.23
CH-2GR6-91	9-1/8" Piston Wear Ring	33.23
CH-2GR6-975	9-3/4" Piston Wear Ring	34.89
<b>PISTON WEAR RINGS</b>		
CH-2WG1-3	3" Piston Wear Ring	\$ 4.96
CH-2WG1-4	4" Piston Wear Ring	10.02
CH-2WG1-5	5" Piston Wear Ring	5.43
CH-2WG1-8	8" Piston Wear Ring	13.24
CH-2WG1-6	6" Piston Wear Ring	6.13
CH-2WG1-7	7" Piston Wear Ring	7.32
CH-2WG1-91	9-1/8" Piston Wear Ring	21.72
<b>PISTON RINGS (DOUBLE ACTING)</b>		
CH-2PR3-35	3-1/2" Piston Ring	\$ 10.42
CH-2PR3-45	4-1/2" Piston Ring	13.95
CH-2PR3-55	5-1/2" Piston Ring	17.92
CH-2PR3-637	6-3/8" Piston Ring	80.53
CH-2PR3-65	6-1/2" Piston Ring	29.02
CH-2PR3-75	7-1/2" Piston Ring	27.25
CH-2PR3-85	8-1/2" Piston Ring	36.71
CH-2PR3-97	9-3/4" Piston Ring	75.55
CH-2PR3-105	10-1/2" Piston Ring	117.72



## CUSTOM HOISTS® TELESCOPICS

CUSTOM HOISTS®

Part Number	Description	List Price
<b>KITS</b>		
CH-35	3" - 5" Vee Set & Wiper	\$ 66.12
CH-46	4" - 6" Vee Set & Wiper	63.98
CH-47	4" - 7" Vee Set & Wiper	122.66
CH-48	4" - 8" Vee Set & Wiper	130.23
CH-48-1/4	4" - 8 - 1/4" Vee Set & Wiper	226.06
CH-49	4" - 9 - 1/8" Vee Set & Wiper	317.28
CH-57	Custom #73-81-114, 129, 149	102.68
CH-57	5" - 7" Vee Set & Wiper	102.68
CH-58	5" - 8" Vee Set & Wiper	147.94
CH-59	5" - 9-1/8" Vee Set & Wiper	297.33
CH-NPB35	3" - 5" Nylon Piston Wear Ring Kit	30.26
CH-NPB36	3" - 6" Nylon Piston Wear Ring Kit	45.21
CH-NPB46	4" - 6" Nylon Piston Wear Ring Kit	36.44
CH-NPB47	4" - 7" Nylon Piston Wear Ring Kit	52.70
CH-NPB48	4" - 8" Nylon Piston Wear Ring Kit	79.50
CH-NPB48-1/4	4" - 8-1/4" Nylon Piston Wear Ring Kit	91.00
CH-NPB49	4" - 9-1/8" Nylon Piston Wear Ring	117.80
CH-NPB57	5" - 7" Piston Wear Ring Kit	43.25
CH-NPB58	5" - 8" Piston Wear Ring Kit	70.01
CH-NPB59	5" - 9-1/8" Piston Wear Ring Kit	108.35
CH-NYB35-DA	2 ea. 3" - 5" Nylon Top Bearings	74.87
CH-NYB35-SA	1 ea. 3" - 5" Nylon Top Bearings	37.44
CH-NYB36-DA	2 ea. 3" - 6" Nylon Top Bearings	105.45
CH-NYB36-SA	1 ea. 3" - 6" Nylon Top Bearings	52.73
CH-NYB46-DA	2 ea. 4" - 6" Nylon Top Bearings	80.85
CH-NYB46-SA	1 ea. 4" - 6" Nylon Top Bearings	40.43
CH-NYB47-DA	2 ea. 4" - 7" Nylon Top Bearings	114.53
CH-NYB47-SA	1 ea. 4" - 7" Nylon Top Bearings	57.03
CH-NYB48-1/4	1 ea. 4" - 8-1/4" Nylon Top Bearings	95.50
CH-NYB48-DA	2 ea. 4" - 8" Nylon Top Bearings	154.28
CH-NYB48-SA	1 ea. 4" - 8" Nylon Top Bearings	77.13
CH-NYB49-DA	2 ea. 4" - 8" Nylon Top Bearing & 1 ea. 9-1/8" Nylon Top Bearings	270.38
CH-NYB57-DA	2 ea. 5" - 7" Nylon Top Bearings	89.53
CH-NYB57-SA	1 ea. 5" - 7" Nylon Top Bearings	44.76
CH-NYB58-DA	2 ea. 5" - 8" Nylon Top Bearings	129.73
CH-NYB58-SA	1 ea. 5" - 8" Nylon Top Bearings	64.86
CH-NYB59-DA	2 ea. 5" - 9-1/8" Nylon Top Bearings	255.64
CH-NYB59-SA	1 ea. 5" - 9" Nylon Top Bearings	128.84
CH-PR35	2 ea. 3-1/2" - 5-1/2" Piston Rings	115.26
CH-PR36	2 ea. 3-1/2" - 6-1/2" Piston Rings	191.89
CH-PR46	2 ea. 4-1/2" - 6-1/2" Piston Rings	160.74
CH-PR47	2 ea. 4-1/2" - 7-1/2" Piston Rings	232.61
CH-PR48	2 ea. 4-1/2" - 8-1/2" Piston Rings	329.43
CH-PR49	2 ea. 4-1/2" - 9-3/4" Piston Rings	528.78
CH-PR57	2 ea. 5-1/2" - 7-1/2" Piston Rings	195.77
CH-PR58	2 ea. 5-1/2" - 8-1/2" Piston Rings	292.59
CH-PR59	2 ea. 5-1/2" - 9-3/4" Piston Rings	491.96
CH-PS1-3	3" Plunger Stop	33.83
CH-PS1-4	4" Plunger Stop	75.86
CH-PS1-5	5" Plunger Stop	81.03

Part Number	Description	List Price
<b>KITS</b>		
CH-PS1-587	5-7/8" Plunger Stop	\$ 96.42
CH-PS1-6	6" Plunger Stop	77.31
CH-PS1-7	7" Plunger Stop	57.29
CH-PS1-8	8" Plunger Stop	50.30
CH-PS1-82	8-1/4" Plunger Stop	88.28
CH-PS1-91	9-1/8" Plunger Stop	96.62
CH-PS1-975	9-3/4" Plunger Stop	99.24
CH-SR35	2 ea. 3-1/2" - 5-1/2" Spiral Retainer	59.30
CH-SR36	2 ea. 3-1/2" - 6-1/2" Spiral Retainer	78.86
CH-SR46	2 ea. 4-1/2" - 6-1/2" Spiral Retainer	71.59
CH-SR47	2 ea. 4-1/2" - 7-1/2" Spiral Retainer	98.24
CH-SR48	2 ea. 4-1/2" - 8-1/2" Spiral Retainer	131.34
CH-SR48-1/4	2 ea. 4-1/2" - 9" Spiral Retainer	377.90
CH-SR49	2 ea. 4-1/2" - 9-3/4" Spiral Retainer	340.04
CH-SR57	2 ea. 5-1/2" - 7-1/2" Spiral Retainer	72.82
CH-SR58	2 ea. 5-1/2" - 8-1/2" Spiral Retainer	105.92
CH-SR59	2 ea. 5-1/2" - 9-3/4" Spiral Retainer	314.63
<b>HEAD NUTS (Measured at thread - have 12th/in)</b>		
CH-2HN-4	4" Head Nut	\$ 73.33
CH-2HN-5	5" Head Nut	75.42
CH-2HN-6	6" Head Nut	99.78
CH-2HN-7	7" Head Nut	104.03
CH-2HN-8	8" Head Nut	125.17
CH-2HN-82	8-1/4" Head Nut	262.07
CH-2HN-9	9" Head Nut	171.66
CH-3HN1-11.25	11-1/4" Head Nut (over 9-3/4" Stage)	479.25
CH-3HN1-9.75	9-3/4" Head Nut (over 8-1/4" Stage)	356.21
CH-3HN1-11.25	11-1/4" Head Nut (over 9-3/4" Stage)	479.25
<b>MISCELLANEOUS PARTS</b>		
CH-ABVA-1	Automatic Bleeder	\$ 45.97
CH-MBVA-1	Manual Bleeder valve	5.18
CH-MBVA-3	OEM Style Manual Bleeder Valve	28.86
CH-SL-2-1	Nylon Slug	0.64
CH-SS-3-1	Set Screw	1.25
<b>MAJOR REPAIR KITS (SINGLE ACTING)</b>		
Kits include: Packing, wipers, nylon bushings, snap rings, piston bearing, set screws and nylon slugs.		
CH-MRK-63	4" - 6"	\$233.80
CH-MRK-74	4" - 7"	224.98
CH-MRK-84	5" - 8"	378.68
CH-MRK-85	4" - 8"	456.48
CH-MRK-95	5" - 9-1/8"	870.17
<b>MAJOR REPAIR KITS (DOUBLE ACTING)</b>		
CH-DAT-MRK-53	3" - 5"	\$ 678.39
CH-DAT-MRK-63	4" - 6"	740.41
CH-DAT-MRK-64	3" - 6"	880.33
CH-DAT-MRK-74	4" - 7"	998.67
CH-DAT-MRK-84	5" - 8"	1092.42
CH-DAT-MRK-85	4" - 8"	1331.26
CH-DAT-MRK-96	4" - 9-1/8"	2211.45



## CUSTOM HOISTS® PISTON-ROD CYLINDERS

Kit Number	Cylinder Number	Code (Pg. xviii)	RodX-Bore Size	List Price	Kit Number	Cylinder Number	Code (Pg. xviii)	RodX-Bore Size	List Price
CH-SK-3-23		I-U-10	2 X 3	\$ 25.73	CH-SK-6-26	DA6-73-34	I-V-5	2-1/2 X 6	\$ 74.31
CH-SK-3-24		I-U-10	1-3/4 X 3	18.37	CH-SK-6-29	DA6-158-42	I-U-5	2-3/4 X 6	94.98
CH-SK-4-4	DA4-77-14	I-V-5	1-3/4 X 4	46.21	CH-SK-6-30	DA6-49-78	I-U-12	4 X 6	113.52
CH-SK-4-5	DA4-107-24	I-U-5	2-1/2 X 4	54.62	CH-SK-6-31	DA6-40-108	I-U-12	4-1/2 X 6	145.23
CH-SK-4-6	DA4-104-48	I-U-5	2 X 4	56.04	CH-SK-6-33		I-U-1	4" Rod Kit	26.18
CH-SK-4-13	DA4-126-28	I-U-5	2-3/4 X 4	54.34	CH-SK-6-34	DA6-100-63	I-V-10	4 X 6	100.68
CH-SK-4-19	SA4-11-25	I-V-1	4" Rod Kit	33.66	CH-SK-6-42	DA6-188-60, DA6-188-52-/12, DA6-194-72	I-V-5	4 X 6	77.86
CH-SK-4-21	DA4-142-21-1/2	I-V-10	2-1/2 X 4	43.78	CH-SK-6-44	DA6-203-42	I-V-5	2-3/4 X 6	96.92
CH-SK-4-23	DA4-171-27-3/4	I-V-10,12	2-3/4 X 4	49.17	CH-SK-6-54	DA6-9-60-1/2, DA6-9-70-1/2	I-V-10	4 X 6	121.83
CH-SK-4-49		I-V-10	2-3/4 X 4	35.81	CH-SK-6-6	DA6-47-47	P-V-5	4 X 6	81.18
CH-SK-4-53		I-U-10	2 X 4	51.48	CH-SK-6-8	DA6-68-79	I-U-5	4 X 6	80.68
CH-SK-4-1/2-6	DA4-1/2-21	I-U-11	2 X 4-1/2	82.30	CH-SK-6-84		I-U-10	5 X 6	60.78
CH-SK-4-1/2-8	DA4-1/2-41-48-5/8	P-U-12	2 X 4-1/2	121.87	CH-SK-7-1	DA7-5	I-U-12	5-1/2 X 7	196.94
CH-SK-4-1/2-15	DA4-1/2-44-21	I-V-5	3 X 4-1/2	63.35	CH-SK-7-16	DA7-4-23	I-V-5	3 X 7	91.41
CH-SK-4-1/2-26		P-UB-10	2 X 4-1/2	70.12	CH-SK-7-17	DA7-78-79	I-V-5	4 X 7	95.45
CH-SK-4-1/2-29		I-V-10	2 X 4-1/2	89.80	CH-SK-7-18	DA-7-29	I-U-10	5-1/2 X 7	146.15
CH-SK-5-1	DA5-67-14	I-U-5	2 X 5	54.01	CH-SK-7-20	DA7-36-78,	I-U-12	4-1/2 X 7	135.77
CH-SK-5-12	DA5-144-36	I-V-11,12	2-1/2 X 5	119.19	CH-SK-7-34		I-V-4, 12	2-1/2 X 7	138.84
CH-SK-5-13	DA5-47-27	I-V-5	3 X 5	91.13	CH-SK-7-35	DA7-121,78,83 or 55	I-U-10	4-1/2 X 7	126.17
CH-SK-5-21	DA5-130-16	I-V-5	2-1/2 X 5	84.70	CH-SK-7-43		I-U-4	2 X 7	57.51
CH-SK-5-28	DA5-41-19,20,23	I-V-5	3 X 5	86.09	CH-SK-7-5	DA7-36-115	I-U-12	4-1/2 X 7	148.44
CH-SK-5-35	DA5-4-26	I-V-9	2-1/2 X 5	71.47	CH-SK-7-9	DA7-63	I-U-10	4-1/2 X 7	148.07
CH-SK-5-1/2-25		I-V-10,12	2-1/2 X 5-1/2	70.47	CH-SK-8-1		I-V-4	3 X 8	113.46
CH-SK-6-1	DA6-60, DA6-88, DA6-90	I-V-1	4-1/2 X 6	40.54	CH-SK-8-21	DA8-16-25	I-V-12	2-1/2 X 8	128.71
CH-SK-6-11	DA6-39-78	I-V-5	4-1/2 X 6	164.37	CH-SK-8-3		I-U-5	3 X 8	125.34
CH-SK-6-15		I-V-5	3-1/2 X 6	100.73	CH-SK-9-2	DA9-19-19	I-V-5	3-1/2 X 9	227.61
CH-SK-6-2	DA6-39-78, DA- 87-67	I-U-12	4-1/2 X 6	119.47	CH-SK-42-60	42-60-43 or CH-475 3"-4" Vee Set & Wiper Telescopic			40.11
CH-SK-6-22	DA6-140	I-V-5	4 x 6	82.11					
CH-SK-6-23	DA6-92-46,62,68	I-V-12	4-1/2 X 6	124.34					

CUSTOM HOISTS®