

STYLE RTUB SUPER-DUTY ROD U-SEALS

Featuring high pressure and high shock load capability, this seal utilizes the same twin lip design found in RTU style. With the main body of the seal molded from high performance polyurethane, this seal incorporates a dynamically designed nitrile energizer and a tough polyacetal anti-extrusion ring. RTUB is capable of pressures up to 10,000 psi in approved applications. Please consult our Engineering department for pressures above 6,000 psi.

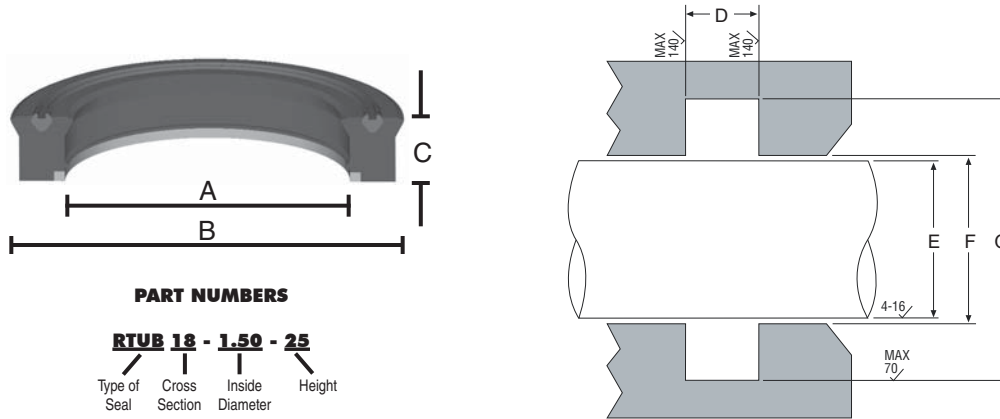

SEAL INFORMATION					
MATERIAL	94A URETHANE SEAL RUBBER ENERGIZER POLYACETAL ANTI-EXTRUSION RING				
MAXIMUM OPERATING CONDITIONS					
MAXIMUM SPEED	PRESSURE RANGE		TEMPERATURE RANGE		
3 FT/SEC	0 - 6,000 PSI		-50° to +230° F		
MAXIMUM EXTRUSION GAP					
PRESSURE	2,400 PSI	3,750 PSI	6,000 PSI	7,500 PSI	10,000 PSI
MAX. DIAM. GAP	.040"	.032"	.024"	.016"	.010"

Part Number	A NOM. I.D.	B NOM. O.D.	C NOM. HT.	D GROOVE WIDTH	E ROD DIAMETER	F THROAT DIAMETER	G HOUSING DIAMETER	List Price
3/16" C/S								
RTUB18-1.50-25	1-1/2	1-7/8	1/4	0.275 +.010 -.000	1.500 -0.0010 -0.0034	1.501 +0.003 -0.000	1.875 ±0.003	\$ 13.34
RTUB18-1.50-31	1-1/2	1-7/8	5/16	0.344 +.010 -.000	1.500 -0.0010 -0.0034	1.501 +0.003 -0.000	1.875 ±0.003	13.34
RTUB18-1.75-25	1-3/4	2-1/8	1/4	0.275 +.010 -.000	1.750 -0.0010 -0.0034	1.751 +0.003 -0.000	2.125 ±0.004	14.27
RTUB18-1.75-37	1-3/4	2-1/8	3/8	0.413 +.010 -.000	1.750 -0.0010 -0.0034	1.751 +0.003 -0.000	2.125 ±0.004	14.34
RTUB18-2.00-37	2	2-3/8	3/8	0.413 +.010 -.000	2.000 -0.0012 -0.0041	2.001 +0.004 -0.000	2.375 ±0.004	16.15
RTUB18-3.75-37	3-3/4	4-1/8	3/8	0.413 +.010 -.000	3.750 -0.0014 -0.0048	3.751 +0.004 -0.000	4.125 ±0.004	32.88

STYLE RTUB SUPER-DUTY ROD U-SEALS



ROD U-SEALS

Part Number	A NOM. I.D.	B NOM. O.D.	C NOM. HT.	D GROOVE WIDTH	E ROD DIAMETER	F THROAT DIAMETER	G HOUSING DIAMETER	List Price
1/4" C/S								
RTUB25-1.37-37	1-3/8	1-7/8	3/8	0.413 +0.010 -0.000	1.375 -0.0010 -0.0034	1.376 +0.003 -0.000	1.875 ±0.003	\$ 13.25
RTUB25-1.50-37	1-1/2	2	3/8	0.413 +0.010 -0.000	1.500 -0.0010 -0.0034	1.501 +0.003 -0.000	2.000 ±0.004	14.62
RTUB25-1.75-37	1-3/4	2-1/4	3/8	0.413 +0.010 -0.000	1.750 -0.0010 -0.0034	1.751 +0.003 -0.000	2.250 ±0.004	16.15
RTUB25-2.00-37	2	2-1/2	3/8	0.413 +0.010 -0.000	2.000 -0.0012 -0.0041	2.001 +0.004 -0.000	2.500 ±0.004	17.59
RTUB25-2.12-37	2-1/8	2-5/8	3/8	0.413 +0.010 -0.000	2.125 -0.0012 -0.0041	2.126 +0.004 -0.000	2.625 ±0.004	18.57
RTUB25-2.25-37	2-1/4	2-3/4	3/8	0.413 +0.010 -0.000	2.250 -0.0012 -0.0041	2.251 +0.004 -0.000	2.750 ±0.004	19.80
RTUB25-2.37-37	2-3/8	2-7/8	3/8	0.413 +0.010 -0.000	2.375 -0.0012 -0.0041	2.376 +0.004 -0.000	2.875 ±0.004	20.62
RTUB25-2.50-37	2-1/2	3	3/8	0.413 +0.010 -0.000	2.500 -0.0012 -0.0041	2.501 +0.004 -0.000	3.000 ±0.004	21.67
RTUB25-2.75-37	2-3/4	3-1/4	3/8	0.413 +0.010 -0.000	2.750 -0.0012 -0.0041	2.751 +0.004 -0.000	3.250 ±0.004	23.75
RTUB25-3.00-37	3	3-1/2	3/8	0.413 +0.010 -0.000	3.000 -0.0012 -0.0041	3.001 +0.004 -0.000	3.500 ±0.004	25.73
RTUB25-3.25-37	3-1/4	3-3/4	3/8	0.413 +0.010 -0.000	3.250 -0.0014 -0.0048	3.251 +0.004 -0.000	3.750 ±0.004	27.49
RTUB25-3.50-37	3-1/2	4	3/8	0.413 +0.010 -0.000	3.500 -0.0014 -0.0048	3.501 +0.004 -0.000	4.000 ±0.004	29.61
RTUB25-4.00-37	4	4-1/2	3/8	0.413 +0.010 -0.000	4.000 -0.0014 -0.0048	4.001 +0.004 -0.000	4.500 ±0.004	33.18
RTUB25-4.00-56	4	4-1/2	9/16	0.618 +0.010 -0.000	4.000 -0.0014 -0.0048	4.001 +0.004 -0.000	4.500 ±0.004	35.98
RTUB25-4.50-37	4-1/2	5	3/8	0.413 +0.010 -0.000	4.500 -0.0014 -0.0048	4.501 +0.004 -0.000	5.000 ±0.005	39.53
RTUB25-4.50-56	4-1/2	5	9/16	0.618 +0.010 -0.000	4.500 -0.0014 -0.0048	4.501 +0.004 -0.000	5.000 ±0.005	39.53
RTUB25-5.00-56	5	5-1/2	9/16	0.618 +0.010 -0.000	5.000 -0.0017 -0.0056	5.001 +0.004 -0.000	5.500 ±0.005	45.02
RTUB25-5.50-56	5-1/2	6	9/16	0.618 +0.010 -0.000	5.500 -0.0017 -0.0056	5.501 +0.004 -0.000	6.000 ±0.005	52.71
RTUB25-6.00-56	6	6-1/2	9/16	0.618 +0.010 -0.000	6.000 -0.0017 -0.0056	6.001 +0.004 -0.000	6.500 ±0.005	58.06
5/16" C/S								
RTUB31-3.00-50	3	3-5/8	1/2	0.550 +0.010 -0.000	3.000 -0.0012 -0.0041	3.001 +0.004 -0.000	3.625 ±0.004	\$ 29.52
RTUB31-3.50-50	3-1/2	4-1/8	1/2	0.550 +0.010 -0.000	3.500 -0.0014 -0.0048	3.501 +0.004 -0.000	4.125 ±0.004	34.32
RTUB31-4.00-56	4	4-5/8	9/16	0.619 +0.010 -0.000	4.000 -0.0014 -0.0048	4.001 +0.004 -0.000	4.625 ±0.004	39.07
RTUB31-4.50-62	4-1/2	5-1/8	5/8	0.688 +0.010 -0.000	4.500 -0.0014 -0.0048	4.501 +0.004 -0.000	5.125 ±0.005	43.51
RTUB31-5.00-62	5	5-5/8	5/8	0.688 +0.010 -0.000	5.000 -0.0017 -0.0056	5.001 +0.004 -0.000	5.625 ±0.005	50.52
3/8" C/S								
RTUB37-3.00-62	3	3-3/4	5/8	0.688 +0.010 -0.000	3.000 -0.0012 -0.0041	3.001 +0.004 -0.000	3.750 ±0.004	\$ 41.80
RTUB37-3.50-62	3-1/2	4-1/4	5/8	0.688 +0.010 -0.000	3.500 -0.0014 -0.0048	3.501 +0.004 -0.000	4.250 ±0.005	47.65
RTUB37-4.00-62	4	4-3/4	5/8	0.688 +0.010 -0.000	4.000 -0.0014 -0.0048	4.001 +0.004 -0.000	4.750 ±0.005	53.54



STYLE RTUB SUPER-DUTY ROD U-SEALS

ROD U-SEALS

Part Number	A NOM. I.D.	B NOM. O.D.	C NOM. HT.	D GROOVE WIDTH	E ROD DIAMETER	F THROAT DIAMETER	G HOUSING DIAMETER	List Price
3/8" C/S								
RTUB37-4.50-62	4-1/2	5-1/4	5/8	0.688 +.010 -.000	4.500 -0.0014 -0.0048	4.501 +0.004 -0.000	5.250 ±0.005	\$ 58.50
RTUB37-5.00-62	5	5-3/4	5/8	0.688 +.010 -.000	5.000 -0.0017 -0.0056	5.001 +0.004 -0.000	5.750 ±0.005	64.06
RTUB37-6.00-62	6	6-3/4	5/8	0.688 +.010 -.000	6.000 -0.0017 -0.0056	6.001 +0.004 -0.000	6.750 ±0.005	75.00

STYLE RTUL LOADED ROD U-SEAL



Molded from high performance polyurethane, style RTUL rod U-seals feature an expander for good low pressure sealing. The twin lip feature reduces friction and promotes stability.

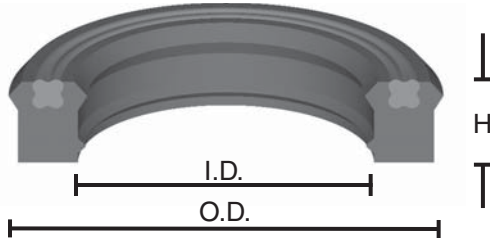

SEAL INFORMATION

MATERIAL	95A URETHANE
TEMPERATURE RANGE	-40° TO +225°F
PRESSURE RANGE	0 TO 5,000 PSI
PART NUMBER	(Prefix)(CS) - (Inside Dia) - (Height)

Part Number	I.D.	O.D.	H.	List Price
7/32" C/S				
RTUL21-1.25-31BHT	1-1/4	1-11/16	5/16	\$ 12.18
RTUL21-1.25-39BHT	1-1/4	1-11/16	0.390	12.18
RTUL21-1.37-31BHT	1-3/8	1-13/16	5/16	12.78
RTUL21-1.37-39BHT	1-3/8	1-13/16	0.390	12.78
RTUL21-1.37-39BHT	1-3/8	1-13/16	0.390	12.78
RTUL21-1.50-37BHT	1-1/2	1-15/16	3/8	13.12
RTUL21-1.62-37BHT	1-5/8	2-1/16	3/8	13.57

Part Number	I.D.	O.D.	H.	List Price
7/32" C/S				
RTUL21-1.62-39BHT	1-5/8	2-1/16	0.390	\$ 13.57
RTUL21-1.75-37BHT	1-3/4	2-3/16	3/8	14.04
RTUL21-1.75-39BHT	1-3/4	2-3/16	0.390	14.04
1/4" C/S				
RTUL25-1.75-37BHT	1-3/4	2-1/4	3/8	\$ 21.77
RTUL25-2.00-37BHT	2	2-1/2	3/8	17.11
RTUL25-2.25-37BHT	2-1/4	2-3/4	3/8	33.63

STYLE RTU ASYMMETRIC TWIN LIP ROD U-SEALS

The twin lip design helps solve difficult rod sealing problems by providing lower friction, increased stability, and high dynamic lip force, while preventing air penetration from outside the cylinder.

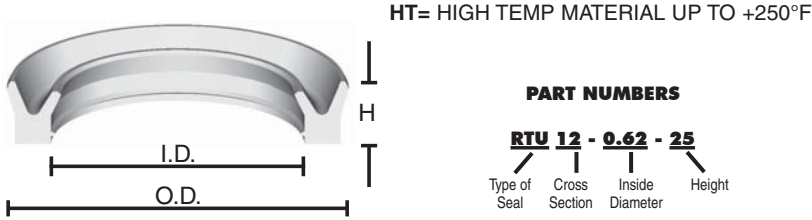

SEAL INFORMATION	
MATERIAL	94A URETHANE
TEMPERATURE RANGE	-40° TO +225°F
PRESSURE RANGE	0 TO 5,000 PSI
PART NUMBER	(Prefix)(CS) - (Inside Dia) - (Height)

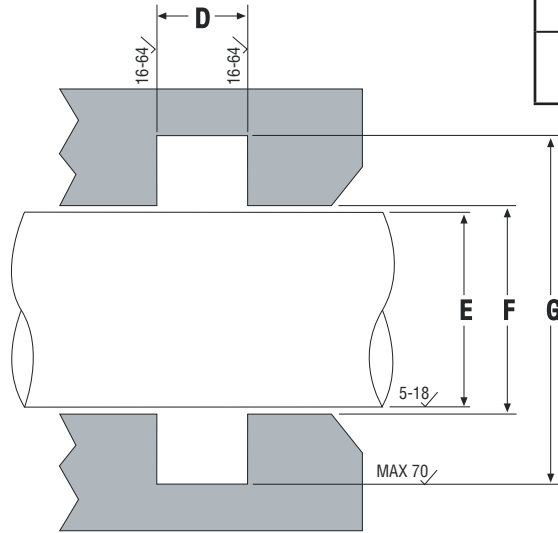

ROD U-SEALS

Part Number	A NOM. I.D.	B NOM. O.D.	C NOM. HT.	D GROOVE WIDTH	E ROD DIAMETER	F THROAT DIAMETER	G HOUSING DIAMETER	List Price
1/8" C/S								
RTU12+0.62+25	5/8	7/8	1/4	0.275 +0.01/0	0.620 -0.0008/-0.0028	0.621 +0.003/0	0.870 ±0.003	\$ 5.84
RTU12-0.75-25	3/4	1	1/4	0.275 +0.01/0	0.750 -0.0008/-0.0028	0.751 +0.003/0	1.000 ±0.003	5.71
RTU12-0.87-25	7/8	1-1/8	1/4	0.275 +0.01/0	0.875 -0.0008/-0.0028	0.876 +0.003/0	1.125 ±0.003	5.57
RTU12-1.00-18	1	1-1/4	3/16	0.207 +0.01/0	1.000 -0.0008/-0.0028	1.001 +0.003/0	1.250 ±0.003	6.18
RTU12-1.00-25	1	1-1/4	1/4	0.275 +0.01/0	1.000 -0.0008/-0.0028	1.001 +0.003/0	1.250 ±0.003	6.09
RTU12-1.12-18	1-1/8	1-3/8	3/16	0.218 +0.01/0	1.125 -0.001/-0.0034	1.126 +0.003/0	1.375 ±0.003	6.22
RTU12-1.12-19	1-1/8	1-3/8	.19	0.218 +0.01/0	1.125 -0.001/-0.0034	1.126 +0.003/0	1.375 ±0.003	14.71
RTU12-1.25-19	1-1/4	1-1/2	.19	0.218 +0.01/0	1.250 -0.001/-0.0034	1.251 +0.003/0	1.500 ±0.003	6.26
RTU12-1.25-25	1-1/4	1-1/2	1/4	0.275 +0.01/0	1.250 -0.001/-0.0034	1.251 +0.003/0	1.500 ±0.003	6.63
RTU12-1.37-19	1-3/8	1-5/8	.19	0.218 +0.01/0	1.000 -0.0008/-0.0028	1.001 +0.003/0	1.625 ±0.003	6.11
RTU12-1.50-25	1-1/2	1-3/4	1/4	0.275 +0.01/0	1.500 -0.001/-0.0034	1.501 +0.003/0	1.750 ±0.003	7.14
RTU12-2.00-25	2	2-1/4	1/4	0.275 +0.01/0	2.000 -0.001/-0.0034	2.001 +0.004/0	2.250 ±0.003	6.83

STYLE RTU ASYMMETRIC TWIN LIP ROD U-SEALS



Part Number	A NOM. I.D.	B NOM. O.D.	C NOM. HT.	D GROOVE WIDTH	E ROD DIAMETER	F THROAT DIAMETER	G HOUSING DIAMETER	List Price
1/5" C/S								
RTU15-1.37-21	1-3/8	1-11/16	.21	0.231 +0.01/0	1.375 -0.001/ -0.0028	1.376 +0.003/0	1.675 ±0.003	\$ 8.26
3/16" C/S								
RTU18-1.00-25	1	1-3/8	1/4	0.275 +0.01/0	1.000 -0.0008/ -0.0028	1.001 +0.003/0	1.375 ±0.003	\$ 5.56
RTU18-1.00-31	1	1-3/8	5/16	0.344 +0.01/0	1.000 -0.0008/ -0.0028	1.001 +0.003/0	1.375 ±0.003	6.52
RTU18-1.12-31	1-1/8	1-1/2	5/16	0.344 +0.01/0	1.125 -0.0008/ -0.0028	1.126 +0.003/0	1.500 ±0.003	6.20
RTU18-1.25-23	1-1/4	1-5/8	15/64	0.257 +0.01/0	1.250 -0.001/ -0.0034	1.251 +0.003/0	1.625 ±0.003	7.00
RTU18-1.25-31	1-1/4	1-5/8	5/16	0.344 +0.01/0	1.250 -0.001/ -0.0034	1.251 +0.003/0	1.625 ±0.003	7.00
RTU18-1.25-37HT	1-1/4	1-5/8	3/8	0.413 +0.01/0	1.250 -0.001/ -0.0034	1.251 +0.003/0	1.625 ±0.003	7.75
RTU18-1.37-31	1-3/8	1-3/4	5/16	0.344 +0.01/0	1.375 -0.001/ -0.0034	1.376 +0.003/0	1.750 ±0.003	6.74
RTU18-1.50-25	1-1/2	1-7/8	1/4	0.275 +0.01/0	1.500 -0.001/ -0.0034	1.501 +0.003/0	1.875 ±0.003	7.51
RTU18-1.50-31	1-1/2	1-7/8	5/16	0.344 +0.01/0	1.500 -0.001/ -0.0034	1.501 +0.003/0	1.875 ±0.003	7.51
RTU18-1.50-37	1-1/2	1-7/8	3/8	0.413 +0.01/0	1.500 -0.001/ -0.0034	1.501 +0.003/0	1.875 ±0.003	7.51
RTU18-1.62-31	1-5/8	2	5/16	0.344 +0.01/0	1.625 -0.001/ -0.0034	1.626 +0.003/0	2.000 ±0.003	10.18
RTU18-1.75-25	1-3/4	2-1/8	1/4	0.275 +0.01/0	1.750 -0.001/ -0.0034	1.751 +0.003/0	2.125 ±0.004	7.29
RTU18-1.75-31	1-3/4	2-1/8	5/16	0.344 +0.01/0	1.750 -0.001/ -0.0034	1.751 +0.003/0	2.125 ±0.004	7.99
RTU18-1.75-37	1-3/4	2-1/8	3/8	0.413 +0.01/0	1.750 -0.0012/ -0.0041	1.751 +0.003/0	2.125 ±0.004	6.45
RTU18-2.00-31	2	2-3/8	5/16	0.344 +0.01/0	2.000 -0.0012/ -0.0041	2.001 +0.003/0	2.375 ±0.004	9.41
RTU18-2.00-37	2	2-3/8	3/8	0.413 +0.01/0	2.000 -0.0012/ -0.0041	2.001 +0.004/0	2.375 ±0.004	8.63
RTU18-2.50-31	2-1/2	2-7/8	5/16	0.344 +0.01/0	2.500 -0.0012/ -0.0041	2.501 +0.004/0	2.875 ±0.004	10.35
RTU18-3.00-37	3	3-3/8	3/8	0.413 +0.01/0	3.000 -0.0012/ -0.0041	3.001 +0.004/0	3.375 ±0.004	11.68
RTU18-3.12-62	3-1/8	3-1/2	5/8	0.688 +0.01/0	3.125 -0.0012/ -0.0041	3.126 +0.004/0	3.500 ±0.004	14.62
RTU18-3.25-56	3-1/4	3-5/8	9/16	0.616 +0.01/0	3.250 -0.0012/ -0.0041	3.251 +0.004/0	3.625 ±0.004	14.62
RTU18-3.50-37	3-1/2	3-7/8	3/8	0.413 +0.01/0	3.500 -0.0014/ -0.0048	3.501 +0.004/0	3.875 ±0.004	14.57
RTU18-4.00-37	4	4-3/8	3/8	0.413 +0.01/0	4.000 -0.0014/ -0.0048	4.001 +0.004/0	4.375 ±0.004	17.15
1/4" C/S								
RTU25-1.00-25	1	1-1/2	1/4	0.275 +0.01/0	1.000 -0.0008/ -0.0028	1.001 +0.003/0	1.500 ±0.003	\$ 6.42
RTU25-1.00-37	1	1-1/2	3/8	0.413 +0.01/0	1.000 -0.0008/ -0.0028	1.001 +0.003/0	1.500 ±0.003	7.08
RTU25-1.25-25	1-1/4	1-3/4	1/4	0.275 +0.01/0	1.250 -0.001/ -0.0034	1.251 +0.003/0	1.750 ±0.003	8.38
RTU25-1.25-37	1-1/4	1-3/4	3/8	0.413 +0.01/0	1.250 -0.001/ -0.0034	1.251 +0.003/0	1.750 ±0.003	7.32
RTU25-1.37-37HT	1-3/8	1-7/8	3/8	0.413 +0.01/0	1.375 -0.001/ -0.0034	1.376 +0.003/0	1.875 ±0.003	16.48
RTU25-1.50-37	1-1/2	2	3/8	0.413 +0.01/0	1.500 -0.001/ -0.0034	1.501 +0.003/0	2.000 ±0.004	8.56

STYLE RTU ASYMMETRIC TWIN LIP ROD U-SEALS

ROD U-SEALS

Part Number	A NOM. I.D.	B NOM. O.D.	C NOM. HT.	D GROOVE WIDTH	E ROD DIAMETER	F THROAT DIAMETER	G HOUSING DIAMETER	List Price
1/4" C/S								
RTU25-1.75-37	1-3/4	2-1/4	3/8	0.413 +0.01/0	1.750 -0.001/ -0.0034	1.751 +0.003/0	2.250 ±0.004	\$ 9.53
RTU25-2.00-31	2	2-1/2	5/16	0.344 +0.01/0	2.000 -0.0012/ -0.0041	2.001 +0.004/0	2.500 ±0.004	9.80
RTU25-2.00-37	2	2-1/2	3/8	0.413 +0.01/0	2.000 -0.0012/ -0.0041	2.001 +0.004/0	2.500 ±0.004	10.36
RTU25-2.25-37	2-1/4	2-3/4	3/8	0.413 +0.01/0	2.250 -0.0012/ -0.0041	2.251 +0.004/0	2.750 ±0.004	11.59
RTU25-2.50-28	2-1/2	3	9/32	0.309 +0.01/0	2.500 -0.0012/ -0.0041	2.501 +0.004/0	3.000 ±0.004	12.47
RTU25-2.50-37	2-1/2	3	3/8	0.413 +0.01/0	2.500 -0.0012/ -0.0041	2.501 +0.004/0	3.000 ±0.004	12.78
RTU25-2.75-31	2-3/4	3-1/4	5/16	0.344 +0.01/0	2.750 -0.0012/ -0.0041	2.751 +0.004/0	3.250 ±0.004	12.78
RTU25-2.75-37	2-3/4	3-1/4	3/8	0.413 +0.01/0	2.750 -0.0012/ -0.0041	2.751 +0.004/0	3.250 ±0.004	13.99
RTU25-3.00-37	3	3-1/2	3/8	0.413 +0.01/0	3.000 -0.0012/ -0.0041	3.001 +0.004/0	3.500 ±0.004	15.12
RTU25-3.00-75	3	3-1/2	3/4	0.825 +0.01/0	3.000 -0.0012/ -0.0041	3.001 +0.004/0	3.500 ±0.004	16.59
RTU25-3.25-37	3-1/4	3-3/4	3/8	0.413 +0.01/0	3.250 -0.0014/ -0.0048	3.251 +0.004/0	3.750 ±0.004	16.16
RTU25-3.50-31	3-1/2	4	5/16	0.344 +0.01/0	3.500 -0.0014/ -0.0048	3.501 +0.004/0	4.000 ±0.004	17.43
RTU25-3.50-37	3-1/2	4	3/8	0.413 +0.01/0	3.500 -0.0014/ -0.0048	3.501 +0.004/0	4.000 ±0.004	17.43
RTU25-4.00-37	4	4-1/2	3/8	0.413 +0.01/0	4.000 -0.0014/ -0.0048	4.001 +0.004/0	4.500 ±0.004	19.54
RTU25-4.00-56	4	4-1/2	9/16	0.618 +0.01/0	4.000 -0.0014/ -0.0048	4.001 +0.004/0	4.500 ±0.004	22.97
RTU25-4.00-75	4	4-1/2	3/4	0.825 +0.01/0	4.000 -0.0014/ -0.0048	4.001 +0.004/0	4.500 ±0.004	21.87
RTU25-4.50-37	4-1/2	5	3/8	0.413 +0.01/0	4.500 -0.0014/ -0.0048	4.501 +0.004/0	5.000 ±0.005	21.22
RTU25-5.00-37	5	5-1/2	3/8	0.413 +0.01/0	5.000 -0.0017/ -0.0056	5.001 +0.004/0	5.500 ±0.005	24.27
RTU25-5.00-75	5	5-1/2	3/4	0.825 +0.01/0	5.000 -0.0017/ -0.0056	5.001 +0.004/0	5.500 ±0.005	24.46
RTU25-5.50-37	5-1/2	6	3/8	0.413 +0.01/0	5.500 -0.0017/ -0.0056	5.501 +0.004/0	6.000 ±0.005	27.79
RTU25-6.00-75	6	6-1/2	3/4	0.825 +0.01/0	6.000 -0.0017/ -0.0056	6.001 +0.004/0	6.500 ±0.005	28.22
RTU25-7.00-75	7	7-1/2	3/4	0.859 +0.01/0	7.000 -0.0017/ -0.0056	7.001 +0.004/0	7.500 ±0.006	37.65
RTU25-8.12-75	8-1/8	8-5/8	3/4	0.825 +0.01/0	8.125 -0.002/ -0.0065	8.126 +0.004/0	8.625 ±0.006	38.73
RTU25-9.37-75	9-3/8	9-7/8	3/4	0.825 +0.01/0	9.375 -0.002/ -0.0065	9.376 +0.004/0	9.875 ±0.006	39.91
5/16" C/S								
RTU31-3.37-59	3-3/8	4	19/32	0.590 +0.01/0	3.375 0.0014/ +0.0048	3.756 +0.004/0	4.355 ±0.006	\$ 18.05
RTU31-4.50-50	4-1/2	5-1/8	1/2	0.550 +0.01/0	4.500 0.0014/ +0.0048	4.501 +0.004/0	5.125 ±0.005	24.50

STYLE RU URETHANE ROD U-SEALS



Style RU seals are molded from high quality urethane and designed specifically for rod applications.

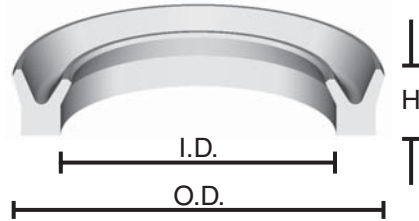

P= HIGH PERFORMANCE
MATERIAL UP TO +275°F

SEAL INFORMATION

MATERIAL	90A URETHANE
TEMPERATURE RANGE	-40° TO +200°F
PRESSURE RANGE	0 TO 5,000 PSI
PART NUMBER	(Prefix)(CS) - (Inside Dia) - (Height)

Part Number	I.D.	O.D.	H.	List Price
3/16" C.S				
RU18-2.00-31P	2	2-3/8	5/16	\$ 22.64
RU18-2.66-30	2.66	3.03	.30	8.56
1/4" C/S				
RU25-1.50-37	1-1/2	2	3/8	\$ 7.21
RU25-1.75-37	1-3/4	2-1/4	3/8	7.93
RU25-1.75-50	1-3/4	2-1/4	1/2	7.93
RU25-2.00-37	2	2-1/2	3/8	8.63
RU25-2.50-37	2-1/2	3	3/8	11.24
RU25-3.00-37	3	3-1/2	3/8	15.93

Part Number	I.D.	O.D.	H.	List Price
5/16" C/S				
RU31-2.62-62	2-5/8	3-1/4	5/8	\$ 12.85
RU31-3.37-50	3-3/8	4	1/2	16.23
RU31-3.75-62	3-3/4	4-3/8	5/8	18.15
RU31-4.62-62	4-5/8	5-1/4	5/8	22.66
RU31-5.75-62	5-3/4	6-3/8	5/8	25.41
RU31-6.75-62	6-3/4	7-3/8	5/8	28.76

STYLE DRU HEAVY DUTY ROD U-SEALS

These seals are specifically designed to seal on their inside diameter and engineered to attain maximum life and reliability in dynamic rod sealing.

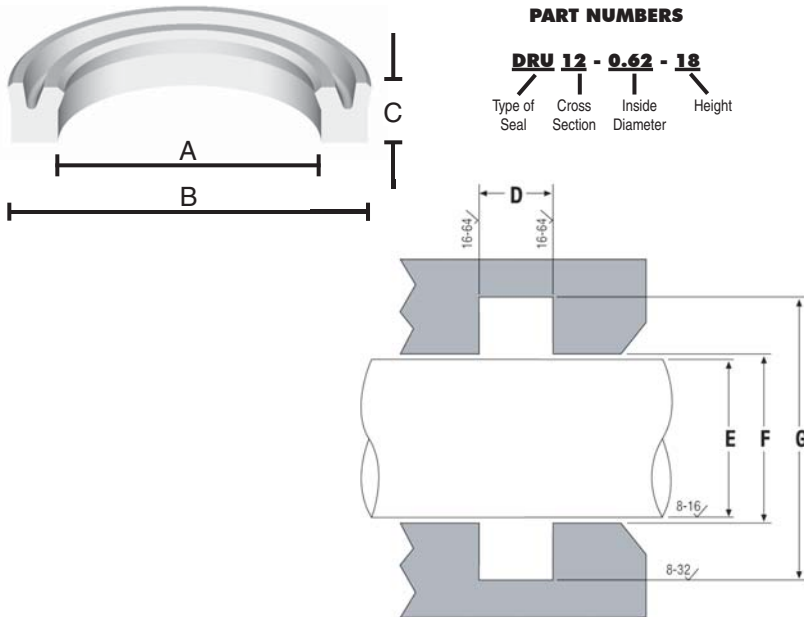

SEAL INFORMATION

MATERIAL	92A URETHANE
TEMPERATURE RANGE	-65° TO +230° F
PRESSURE RANGE	0 TO 6,000 PSI
PART NUMBER	(Prefix)(CS) - (Inside Dia) - (Height)

Part Number	A NOM. I.D.	B NOM. O.D.	C NOM. HT.	D GROOVE WIDTH	E ROD DIAMETER	F THROAT DIAMETER	G HOUSING DIAMETER	List Price
1/8" C/S								
DRU12-0.62-18	5/8	7/8	3/16	0.218 +0.015/0	0.625 +0/-0.003	0.626 +0.003/0	0.875 +0.005/0	\$ 7.61
DRU12-0.75-12	3/4	1	1/8	0.156 +0.015/0	0.750 +0/-0.003	0.751 +0.003/0	1.000 +0.005/0	6.49
DRU12-0.75-25	3/4	1	1/4	0.281 +0.015/0	0.750 +0/-0.003	0.751 +0.003/0	1.000 +0.005/0	7.70
DRU12-0.87-12	7/8	1-1/8	1/8	0.156 +0.015/0	0.875 +0/-0.003	0.876 +0.003/0	1.125 +0.005/0	7.32
DRU12-1.00-12	1	1-1/4	1/8	0.156 +0.015/0	1.000 +0/-0.003	1.001 +0.003/0	1.250 +0.005/0	7.90
DRU12-1.00-18	1	1-1/4	3/16	0.218 +0.015/0	1.000 +0/-0.003	1.001 +0.003/0	1.250 +0.005/0	7.04
3/16" C/S								
DRU18-0.87-18	7/8	1-1/4	3/16	0.218 +0.015/0	0.875 +0/-0.003	0.876 +0.003/0	1.250 +0.005/0	\$ 6.85
DRU18-0.87-25	7/8	1-1/4	1/4	0.218 +0.015/0	0.875 +0/-0.003	0.876 +0.003/0	1.250 +0.005/0	7.86
DRU18-1.12-37	1-1/8	1-1/2	3/8	0.406 +0.015/0	1.125 +0/-0.003	1.126 +0.003/0	1.500 +0.007/0	7.38
DRU18-1.75-25	1-3/4	2-1/8	1/4	0.281 +0.015/0	1.750 +0/-0.003	1.751 +0.003/0	2.125 +0.008/0	10.90
DRU18-1.87-31	1-7/8	2-1/4	5/16	0.343 +0.015/0	1.875 +0/-0.003	1.876 +0.003/0	2.250 +0.008/0	23.02
DRU18-2.00-25	2	2-3/8	1/4	0.281 +0.015/0	2.000 +0/-0.003	2.001 +0.004/0	2.375 +0.008/0	12.93
DRU18-2.25-31	2-1/4	2-5/8	5/16	0.343 +0.015/0	2.250 +0/-0.003	2.251 +0.004/0	2.625 +0.008/0	13.75
DRU18-2.50-31	2-1/2	2-7/8	5/16	0.343 +0.015/0	2.500 +0/-0.003	2.501 +0.004/0	2.875 +0.008/0	19.12
1/4" C/S								
DRU25-0.93-37	15/16	1-7/16	3/8	0.406 +0.015/0	0.937 +0/-0.003	0.938 +0.003/0	1.437 +0.005/0	\$ 7.16
DRU25-1.00-25	1	1-1/2	1/4	0.281 +0.015/0	1.000 +0/-0.003	1.001 +0.003/0	1.500 +0.007/0	7.16
DRU25-1.12-25	1-1/8	1-5/8	1/4	0.281 +0.015/0	1.125 +0/-0.003	1.126 +0.003/0	1.625 +0.007/0	9.09
DRU25-1.25-25	1-1/4	1-3/4	1/4	0.281 +0.015/0	1.250 +0/-0.003	1.251 +0.003/0	1.750 +0.007/0	8.83

STYLE DRU HEAVY DUTY ROD U-SEALS



ROD U-SEALS

Part Number	A NOM. I.D.	B NOM. O.D.	C NOM. HT.	D GROOVE WIDTH	E ROD DIAMETER	F THROAT DIAMETER	G HOUSING DIAMETER	List Price
1/4" C/S								
DRU25-1.25-31	1-1/4	1-3/4	5/16	0.343 +0.015/0	1.250 +0/-0.003	1.251 +0.003/0	1.750 +0.007/0	\$ 8.83
DRU25-1.50-31	1-1/2	2	5/16	0.343 +0.015/0	1.500 +0/-0.003	1.501 +0.003/0	2.000 +0.008/0	10.52
DRU25-1.62-31	1-5/8	2-1/8	5/16	0.343 +0.015/0	1.625 +0/-0.003	1.626 +0.003/0	2.125 +0.008/0	11.53
DRU25-1.87-37	1-7/8	2-3/8	3/8	0.406 +0.015/0	1.875 +0/-0.003	1.876 +0.003/0	2.375 +0.008/0	28.15
DRU25-2.00-25	2	2-1/2	1/4	0.281 +0.015/0	2.000 +0/-0.003	2.001 +0.004/0	2.500 +0.008/0	13.57
DRU25-2.00-31	2	2-1/2	5/16	0.343 +0.015/0	2.000 +0/-0.003	2.001 +0.004/0	2.500 +0.008/0	13.57
DRU25-2.12-37	2-1/8	2-5/8	3/8	0.406 +0.015/0	2.125 +0/-0.003	2.126 +0.004/0	2.625 +0.008/0	19.85
DRU25-2.37-37	2-3/8	2-7/8	3/8	0.406 +0.015/0	2.375 +0/-0.003	2.376 +0.004/0	2.875 +0.008/0	13.75
DRU25-2.50-25	2-1/2	3	1/4	0.281 +0.015/0	2.500 +0/-0.003	2.501 +0.004/0	3.000 +0.008/0	14.08
DRU25-2.50-31	2-1/2	3	5/16	0.343 +0.015/0	2.500 +0/-0.003	2.501 +0.004/0	3.000 +0.008/0	14.08
DRU25-2.62-37	2-5/8	3-1/8	3/8	0.406 +0.015/0	2.625 +0/-0.003	2.626 +0.004/0	3.125 +0.008/0	14.37
DRU25-3.37-37	3-3/8	3-7/8	3/8	0.406 +0.015/0	3.375 +0/-0.004	3.376 +0.004/0	3.875 +0.009/0	15.64
DRU25-3.75-59	3-3/4	4-1/4	19/32	0.625 +0.015/0	3.750 +0/-0.004	3.751 +0.004/0	4.250 +0.009/0	39.41
DRU25-4.00-25	4	4-1/2	1/4	0.281 +0.015/0	4.000 +0/-0.004	4.001 +0.004/0	4.500 +0.009/0	23.87
DRU25-4.00-56	4	4-1/2	9/16	0.532 +0.015/0	4.000 +0/-0.004	4.001 +0.004/0	4.500 +0.009/0	20.98
DRU25-4.50-56	4-1/2	5	9/16	0.593 +0.015/0	4.500 +0/-0.004	4.501 +0.004/0	5.000 +0.01/0	24.81
DRU25-5.00-56	5	5-1/2	9/16	0.532 +0.015/0	5.000 +0/-0.004	5.001 +0.004/0	5.500 +0.01/0	31.41
DRU25-5.25-59	5-1/4	5-3/4	19/32	0.625 +0.015/0	5.250 +0/-0.004	5.251 +0.004/0	5.750 +0.01/0	57.06
DRU25-6.75-59	6-3/4	7-1/4	19/32	0.625 +0.015/0	6.750 +0/-0.004	6.751 +0.004/0	7.250 +0.011/0	73.96
5/16" C/S								
DRU31-1.37-37	1-3/8	2	3/8	0.406 +0.015/0	1.375 +0/-0.003	1.376 +0.003/0	2.000 +0.008/0	\$ 10.52
DRU31-2.00-37	2	2-5/8	3/8	0.406 +0.015/0	2.000 +0/-0.003	2.001 +0.004/0	2.625 +0.008/0	13.17
DRU31-2.25-37	2-1/4	2-7/8	3/8	0.406 +0.015/0	2.250 +0/-0.003	2.251 +0.004/0	2.875 +0.008/0	15.64
DRU31-2.25-50	2-1/4	2-7/8	1/2	0.531 +0.015/0	2.250 +0/-0.003	2.251 +0.004/0	2.875 +0.008/0	15.64
DRU31-2.37-37	2-3/8	3	3/8	0.406 +0.015/0	2.375 +0/-0.003	2.376 +0.004/0	3.000 +0.008/0	14.08
DRU31-2.37-50	2-3/8	3	1/2	0.531 +0.015/0	2.375 +0/-0.003	2.376 +0.004/0	3.000 +0.008/0	14.87
DRU31-2.75-37	2-3/4	3-3/8	3/8	0.406 +0.015/0	2.750 +0/-0.003	2.751 +0.004/0	3.375 +0.009/0	16.65
DRU31-3.00-37	3	3-5/8	3/8	0.406 +0.015/0	3.000 +0/-0.004	3.001 +0.004/0	3.625 +0.009/0	17.32
DRU31-3.37-50	3-3/8	4	1/2	0.531 +0.015/0	3.375 +0/-0.004	3.376 +0.004/0	4.000 +0.009/0	20.19
DRU31-3.75-50	3-3/4	4-3/8	1/2	0.531 +0.015/0	3.750 +0/-0.004	3.751 +0.004/0	4.375 +0.009/0	25.12
DRU31-4.00-50	4	4-5/8	1/2	0.531 +0.015/0	4.000 +0/-0.004	4.001 +0.004/0	4.625 +0.009/0	25.12
DRU31-4.50-37	4-1/2	5-1/8	3/8	0.406 +0.015/0	4.500 +0/-0.004	4.501 +0.004/0	5.125 +0.01/0	28.96
DRU31-5.50-37	5-1/2	6-1/8	3/8	0.406 +0.015/0	5.500 +0/-0.001	5.501 +0.004/0	6.125 +0.01/0	41.51
3/8" C/S								
DRU37-2.00-37	2	2-3/4	3/8	0.406 +0.015/0	2.000 +0/-0.003	2.001 +0.004/0	2.750 +0.008/0	\$ 14.08
DRU37-2.00-50	2	2-3/4	1/2	0.531 +0.015/0	2.000 +0/-0.003	2.001 +0.004/0	2.750 +0.008/0	14.08
DRU37-3.00-37	3	3-3/4	3/8	0.406 +0.015/0	3.000 +0/-0.004	3.001 +0.004/0	3.750 +0.009/0	16.68
DRU37-3.00-62	3	3-3/4	5/8	0.656 +0.015/0	3.000 +0/-0.004	3.001 +0.004/0	3.750 +0.009/0	18.96
DRU37-3.50-37	3-1/2	4-1/4	3/8	0.406 +0.015/0	3.500 +0/-0.004	3.501 +0.004/0	4.250 +0.009/0	21.95
DRU37-3.50-50	3-1/2	4-1/4	1/2	0.531 +0.015/0	3.500 +0/-0.004	3.501 +0.004/0	4.250 +0.009/0	21.95

STYLE DRU HEAVY DUTY ROD U-SEALS

ROD U-SEALS

Part Number	A NOM. I.D.	B NOM. O.D.	C NOM. HT.	D GROOVE WIDTH	E ROD DIAMETER	F THROAT DIAMETER	G HOUSING DIAMETER	List Price
3/8" C/S								
DRU37-3.62-37	3-5/8	4-3/8	3/8	0.406 +0.015/0	3.625 +0/-0.004	3.626 +0.004/0	4.375 +0.009/0	\$ 21.95
DRU37-4.00-37	4	4-3/4	3/8	0.406 +0.015/0	4.000 +0/-0.004	4.001 +0.004/0	4.750 +0.009/0	25.12
DRU37-4.00-50	4	4-3/4	1/2	0.531 +0.015/0	4.000 +0/-0.004	4.001 +0.004/0	4.750 +0.009/0	25.12
DRU37-4.00-62	4	4-3/4	5/8	0.656 +0.015/0	4.000 +0/-0.004	4.001 +0.004/0	4.750 +0.009/0	38.88
DRU37-4.25-50	4-1/4	5	1/2	0.531 +0.015/0	4.250 +0/-0.004	4.251 +0.004/0	5.000 +0.01/0	24.59
DRU37-4.25-62	4-1/4	5	5/8	0.656 +0.015/0	4.250 +0/-0.004	4.251 +0.004/0	5.000 +0.01/0	25.45
DRU37-4.37-50	4-3/8	5-1/8	1/2	0.531 +0.015/0	4.375 +0/-0.004	4.376 +0.004/0	5.125 +0.01/0	35.00
DRU37-4.50-50	4-1/2	5-1/4	1/2	0.531 +0.015/0	4.500 +0/-0.004	4.501 +0.004/0	5.250 +0.01/0	26.36
DRU37-4.50-62	4-1/2	5-1/4	5/8	0.656 +0.015/0	4.500 +0/-0.004	4.501 +0.004/0	5.250 +0.01/0	26.14
DRU37-4.75-37	4-3/4	5-1/2	3/8	0.406 +0.015/0	4.750 +0/-0.004	4.751 +0.004/0	5.500 +0.01/0	33.52
DRU37-4.87-50	4-7/8	5-5/8	1/2	0.531 +0.015/0	4.875 +0/-0.004	4.876 +0.004/0	5.625 +0.01/0	44.67
DRU37-5.25-62	5-1/4	6	5/8	0.687 +0.015/0	5.250 +0/-0.004	5.251 +0.004/0	6.000 +0.01/0	39.87
DRU37-5.75-62	5-3/4	6-1/2	5/8	0.656 +0.015/0	5.750 +0/-0.004	5.751 +0.004/0	6.500 +0.01/0	54.29
DRU37-6.00-62	6	6-3/4	5/8	0.656 +0.015/0	6.000 +0/-0.004	6.001 +0.004/0	6.750 +0.01/0	56.96
DRU37-6.50-50	6-1/2	7-1/4	1/2	0.531 +0.015/0	6.500 +0/-0.004	6.501 +0.004/0	7.250 +0.011/0	62.26
DRU37-6.50-62	6-1/2	7-1/4	5/8	0.656 +0.015/0	6.500 +0/-0.004	6.501 +0.004/0	7.250 +0.011/0	74.67
DRU37-7.00-50	7	7-3/4	1/2	0.531 +0.015/0	7.000 +0/-0.004	7.001 +0.004/0	7.750 +0.011/0	67.85
DRU37-7.00-62	7	7-3/4	5/8	0.656 +0.015/0	7.000 +0/-0.004	7.001 +0.004/0	7.750 +0.011/0	73.38
7/16" C/S								
DRU43-4.50-48	4-1/2	5-3/8	7/16	0.512 +0.015/0	4.500 +0/-0.004	4.501 +0.004/0	5.375 +0.01/0	\$ 38.20
1/2" C/S								
DRU50-5.00-75	5	6	3/4	0.781 +0.015/0	5.000 +0/-0.004	5.001 +0.004/0	6.000 +0.01/0	\$ 64.52
DRU50-7.00-69	7	8	11/16	0.747 +0.015/0	7.000 +0/-0.005	7.001 +0.004/0	8.000 +0.011/0	78.88
DRU50-7.00-75	7	8	3/4	0.781 +0.015/0	7.000 +0/-0.005	7.001 +0.004/0	8.000 +0.011/0	79.65
DRU50-9.00-62	9	10	5/8	0.656 +0.015/0	9.000 +0/-0.005	9.001 +0.004/0	10.000 +0.012/0	89.25
DRU50-9.00-75	9	10	3/4	0.781 +0.015/0	9.000 +0/-0.005	9.001 +0.004/0	10.000 +0.012/0	102.41
DRU50-10.00-62	10	11	5/8	0.656 +0.015/0	10.000 +0/-0.006	10.001 +0.004/0	11.000 +0.012/0	107.32
DRU50-12.00-75	12	13	3/4	0.781 +0.015/0	12.000 +0/-0.006	12.001 +0.004/0	13.000 +0.012/0	149.29
3/4" C/S								
DRU75-8.00-62	8	9-1/2	5/8	0.656 +0.015/0	8.000 +0/-0.005	8.001 +0.004/0	9.500 +0.012/0	\$ 139.03

STYLE DRU HEAVY DUTY ROD U-SEALS



DON'T DAMAGE THAT U-SEAL TRY OUR ROD U-SEAL INSTALLATION TOOLS

These handy tools aid U-seal installation, eliminating the risk of damaging the seal lip.

Part Number	Seal ID Range	List Price
IT 100	3/4" to 1-1/4"	\$ 65.27
IT 150	1-3/8" to 1-7/8"	65.27
IT 200	2" to 3"	65.27
IT 100-NN	3/4" to 1-1/4"	65.27
IT 150-NN	1-3/8" to 1-7/8"	65.27
IT 200-NN	2" to 3"	65.27



STYLE DRTU HEAVY DUTY ROD U-SEALS

These seals are specifically designed with a second lip on their inside diameter and engineered to attain maximum life and reliability in dynamic rod sealing. This feature results in reduced leakage, less friction, increased stability, and prevents air and contaminants from entering the cylinder.

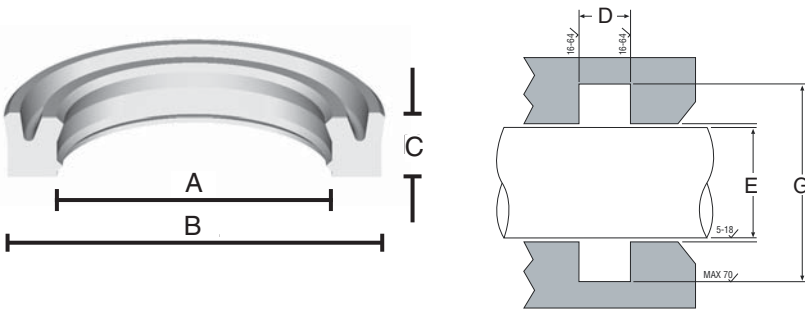

PART NUMBERS

DRTU 12 - 0.75 - 25
 Type of Seal Cross Section Inside Diameter Height

SEAL INFORMATION

MATERIAL	92A URETHANE
MAX SPEED	3 FT/SEC
TEMPERATURE RANGE	-65° TO +230° F
PRESSURE RANGE	0 TO 6,000 PSI

MAXIMUM EXTRUSION GAP

PRESSURE	1000 PSI	3000 PSI	5000 PSI	6000 PSI
MAX DIAM. GAP	0.032"	0.015"	0.012"	0.009"

Part Number	A I.D.	B O.D.	C HT.	G GROOVE O.D.		D GROOVE WIDTH		E ROD DIAMETER		List Price
1/8" C/S										
DRTU12-0.75-25	3/4	1	1/4	1.000	+0.005 -0.000	0.275	+0.015 -0.000	0.750	+0.000 -0.003	\$ 7.97
DRTU12-1.00-25	1	1-1/4	1/4	1.250	+0.005 -0.000	0.275	+0.015 -0.000	1.000	+0.000 -0.003	7.04
3/16" C/S										
DRTU18-0.75-25	3/4	1-1/8	1/4	1.125	+0.005 -0.000	0.275	+0.015 -0.000	0.750	+0.000 -0.003	\$ 7.86
DRTU18-0.75-31	3/4	1-1/8	5/16	1.125	+0.005 -0.000	0.344	+0.015 -0.000	0.750	+0.000 -0.003	7.14
DRTU18-1.00-31	1	1-3/8	5/16	1.375	+0.005 -0.000	0.344	+0.015 -0.000	1.000	+0.000 -0.003	7.07
DRTU18-1.12-25	1-1/8	1-1/2	1/4	1.500	+0.007 -0.000	0.275	+0.015 -0.000	1.125	+0.000 -0.003	8.99
DRTU18-1.12-31	1-1/8	1-1/2	5/16	1.500	+0.007 -0.000	0.344	+0.015 -0.000	1.125	+0.000 -0.003	7.38
DRTU18-1.25-31	1-1/4	1-5/8	5/16	1.625	+0.007 -0.000	0.344	+0.015 -0.000	1.250	+0.000 -0.003	10.19
DRTU18-1.25-37	1-1/4	1-5/8	3/8	1.625	+0.007 -0.000	0.413	+0.015 -0.000	1.250	+0.000 -0.003	8.29
DRTU18-1.37-31	1-3/8	1-3/4	5/16	1.750	+0.007 -0.000	0.344	+0.015 -0.000	1.375	+0.000 -0.003	9.54
DRTU18-1.50-25	1-1/2	1-7/8	1/4	1.875	+0.007 -0.000	0.275	+0.015 -0.000	1.500	+0.000 -0.003	9.54
DRTU18-1.50-31	1-1/2	1-7/8	5/16	1.875	+0.007 -0.000	0.344	+0.015 -0.000	1.500	+0.000 -0.003	9.54
DRTU18-1.50-37	1-1/2	1-7/8	3/8	1.875	+0.007 -0.000	0.413	+0.015 -0.000	1.500	+0.000 -0.003	9.54
DRTU18-1.62-37	1-5/8	2	3/8	2.000	+0.008 -0.000	0.413	+0.015 -0.000	1.625	+0.000 -0.003	10.72
DRTU18-1.75-31	1-3/4	2-1/8	5/16	2.125	+0.008 -0.000	0.344	+0.015 -0.000	1.750	+0.000 -0.003	10.90
DRTU18-1.75-37	1-3/4	2-1/8	3/8	2.125	+0.008 -0.000	0.413	+0.015 -0.000	1.750	+0.000 -0.003	10.90

STYLE DRTU HEAVY DUTY ROD U-SEALS



ROD U-SEALS

Part Number	A I.D.	B O.D.	C HT.	G GROOVE O.D.	D GROOVE WIDTH	E ROD DIAMETER	List Price
3/16" C/S							
DRTU18-1.87-37	1-7/8	2-1/4	3/8	2.250 +0.008 -0.000	0.413 +0.015 -0.000	1.875 +0.000 -0.003	\$ 12.61
DRTU18-2.00-31	2	2-3/8	5/16	2.375 +0.008 -0.000	0.344 +0.015 -0.000	2.000 +0.000 -0.003	12.93
DRTU18-2.00-37	2	2-3/8	3/8	2.375 +0.008 -0.000	0.413 +0.015 -0.000	2.000 +0.000 -0.003	12.93
DRTU18-2.25-37	2-1/4	2-5/8	3/8	2.625 +0.008 -0.000	0.413 +0.015 -0.000	2.250 +0.000 -0.003	13.75
DRTU18-2.50-37	2-1/2	2-7/8	3/8	2.875 +0.008 -0.000	0.413 +0.015 -0.000	2.500 +0.000 -0.003	16.51
1/4" C/S							
DRTU25-1.00-37	1	1-1/2	3/8	1.500 +0.007 -0.000	0.413 +0.015 -0.000	1.000 +0.000 -0.003	\$ 7.16
DRTU25-1.25-37	1-1/4	1-3/4	3/8	1.750 +0.007 -0.000	0.413 +0.015 -0.000	1.250 +0.000 -0.003	8.83
DRTU25-1.37-37	1-3/8	1-7/8	3/8	1.875 +0.007 -0.000	0.413 +0.015 -0.000	1.375 +0.000 -0.003	9.56
DRTU25-1.50-37	1-1/2	2	3/8	2.000 +0.008 -0.000	0.413 +0.015 -0.000	1.500 +0.000 -0.003	10.52
DRTU25-1.75-31	1-3/4	2-1/4	5/16	2.250 +0.008 -0.000	0.344 +0.015 -0.000	1.750 +0.000 -0.003	11.83
DRTU25-1.75-37	1-3/4	2-1/4	3/8	2.250 +0.008 -0.000	0.413 +0.015 -0.000	1.750 +0.000 -0.003	11.83
DRTU25-2.00-37	2	2-1/2	3/8	2.500 +0.008 -0.000	0.413 +0.015 -0.000	2.000 +0.000 -0.003	13.58
DRTU25-2.25-37	2-1/4	2-3/4	3/8	2.750 +0.008 -0.000	0.413 +0.015 -0.000	2.250 +0.000 -0.003	14.45
DRTU25-2.37-37	2-3/8	2-7/8	3/8	2.875 +0.008 -0.000	0.413 +0.015 -0.000	2.375 +0.000 -0.003	13.75
DRTU25-2.50-37	2-1/2	3	3/8	3.000 +0.008 -0.000	0.413 +0.015 -0.000	2.500 +0.000 -0.003	14.08
DRTU25-2.75-37	2-3/4	3-1/4	3/8	3.250 +0.009 -0.000	0.413 +0.015 -0.000	2.750 +0.000 -0.003	14.37
DRTU25-3.00-37	3	3-1/2	3/8	3.500 +0.009 -0.000	0.413 +0.015 -0.000	3.000 +0.000 -0.004	14.83
DRTU25-3.25-31	3-1/4	3-3/4	5/16	3.750 +0.009 -0.000	0.344 +0.015 -0.000	3.250 +0.000 -0.004	15.64
DRTU25-3.25-37	3-1/4	3-3/4	3/8	3.750 +0.009 -0.000	0.413 +0.015 -0.000	3.250 +0.000 -0.004	15.64
DRTU25-3.50-37	3-1/2	4	3/8	4.000 +0.009 -0.000	0.413 +0.015 -0.000	3.500 +0.000 -0.004	16.34
DRTU25-3.75-37	3-3/4	4-1/4	3/8	4.250 +0.009 -0.000	0.413 +0.015 -0.000	3.750 +0.000 -0.004	19.18
DRTU25-4.00-37	4	4-1/2	3/8	4.500 +0.009 -0.000	0.413 +0.015 -0.000	4.000 +0.000 -0.004	20.98
DRTU25-4.50-56	4-1/2	5	9/16	5.000 +0.010 -0.000	0.618 +0.015 -0.000	4.500 +0.000 -0.004	24.81
DRTU25-4.75-56	4-3/4	5-1/4	9/16	5.250 +0.010 -0.000	0.618 +0.015 -0.000	4.750 +0.000 -0.004	31.13
DRTU25-5.50-56	5-1/2	6	9/16	6.000 +0.010 -0.000	0.618 +0.015 -0.000	5.500 +0.000 -0.004	39.49
5/16" C/S							
DRTU31-1.75-37	1-3/4	2-3/8	3/8	2.375 +0.008 -0.000	0.413 +0.015 -0.000	1.750 +0.000 -0.003	\$ 11.85
DRTU31-1.75-50	1-3/4	2-3/8	1/2	2.375 +0.008 -0.000	0.550 +0.015 -0.000	1.750 +0.000 -0.003	11.85
DRTU31-2.00-50	2	2-5/8	1/2	2.625 +0.008 -0.000	0.550 +0.015 -0.000	2.000 +0.000 -0.003	13.17
DRTU31-2.50-50	2-1/2	3-1/8	1/2	3.125 +0.008 -0.000	0.550 +0.015 -0.000	2.500 +0.000 -0.003	15.75

STYLE DRTU HEAVY DUTY ROD U-SEALS

ROD U-SEALS

Part Number	A I.D.	B O.D.	C HT.	G GROOVE O.D.	D GROOVE WIDTH	E ROD DIAMETER	List Price
5/16" C/S							
DRTU31-2.75-50	2-3/4	3-3/8	1/2	3.375 +0.009 -0.000	0.550 +0.015 -0.000	2.750 +0.000 -0.003	\$ 16.65
DRTU31-3.00-50	3	3-5/8	1/2	3.625 +0.009 -0.000	0.550 +0.015 -0.000	3.000 +0.000 -0.004	18.05
DRTU31-4.00-37	4	4-5/8	3/8	4.625 +0.009 -0.000	0.413 +0.015 -0.000	4.000 +0.000 -0.004	25.12
3/8" C/S							
DRTU37-2.75-62	2-3/4	3-1/2	5/8	3.500 +0.009 -0.000	0.687 +0.015 -0.000	2.750 +0.000 -0.003	\$ 18.30
DRTU37-3.00-50	3	3-3/4	1/2	3.750 +0.009 -0.000	0.550 +0.015 -0.000	3.000 +0.000 -0.004	17.60
DRTU37-3.50-62	3-1/2	4-1/4	5/8	4.250 +0.009 -0.000	0.687 +0.015 -0.000	3.500 +0.000 -0.004	21.95
DRTU37-4.00-62	4	4-3/4	5/8	4.750 +0.009 -0.000	0.687 +0.015 -0.000	4.000 +0.000 -0.004	25.12
DRTU37-4.50-62	4-1/2	5-1/4	5/8	5.250 +0.010 -0.000	0.687 +0.015 -0.000	4.500 +0.000 -0.004	31.41
DRTU37-4.75-62	4-3/4	5-1/2	5/8	5.500 +0.010 -0.000	0.687 +0.015 -0.000	4.750 +0.000 -0.004	33.52
DRTU37-5.00-62	5	5-3/4	5/8	5.750 +0.010 -0.000	0.687 +0.015 -0.000	5.000 +0.000 -0.004	51.29

STYLE DRUB HEAVY DUTY ROD U-SEALS



These seals are specifically designed to seal on their inside diameter and engineered to attain maximum life and reliability in dynamic rod sealing. They employ a hard plastic I.D. back-up ring to reduce the possibility of extrusion.

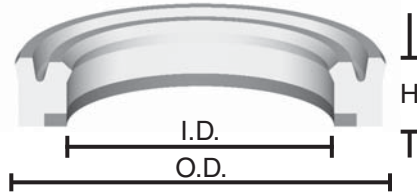

Part Number	I.D.	O.D.	H.	List Price
DRUB25-2.37-37	2-3/8	2-7/8	3/8	\$ 41.44
DRUB25-2.50-37	2-1/2	3	3/8	38.08
DRUB37-5.75-62	5-3/4	6-1/2	5/8	59.53

SEAL INFORMATION	
MATERIAL	92A URETHANE
TEMPERATURE RANGE	-40° TO +230° F
PRESSURE RANGE	0 TO 6,000 PSI
PART NUMBER	(Prefix)(CS) - (Inside Dia) - (Height)

STYLE UFN-EI ROD SEALS W/BACK-UP RINGS

Incorporating a rubber seal lip, a rubberized fabric heel, and an acetal back-up ring, this seal provides excellent sealability and high extrusion resistance.

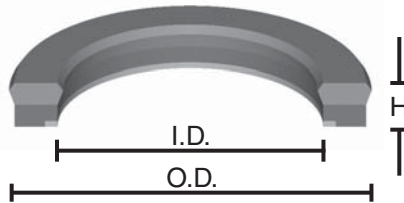

SEAL INFORMATION	
MATERIAL	RUBBER, FABRIC, ACETAL
TEMPERATURE RANGE	-22° TO +212° F
PRESSURE RANGE	0 TO 5,800 PSI
PART NUMBER	(Prefix)(CS) - (Inside Dia) - (Height)

Part Number	I.D.	O.D.	H.	List Price
1/8" C/S				
UFN12-1.00-18EI	1	1-1/4	3/16	\$ 6.38
UFN12-1.12-18EI	1-1/8	1-3/8	3/16	7.60
5/32" C/S				
UFN15-2.00-25EI	2	2-5/16	1/4	\$ 8.88
0.17" C/S				
UFN17-0.75-28EI	3/4	1.09	9/32	\$ 6.93
3/16" C/S				
UFN18-0.62-28EI	5/8	1	9/32	\$ 6.93
UFN18-0.75-31EI	3/4	1-1/8	5/16	7.74
UFN18-1.00-25EI	1	1-3/8	1/4	6.60
UFN18-1.25-25EI	1-1/4	1-5/8	1/4	6.82
UFN18-1.25-28EI	1-1/4	1-5/8	9/32	6.50
UFN18-1.37-28EI	1-3/8	1-3/4	9/32	9.55
UFN18-1.50-25EI	1-1/2	1-7/8	1/4	8.18
UFN18-1.50-28EI	1-1/2	1-7/8	9/32	7.15
UFN18-1.75-28EI	1-3/4	2-1/8	9/32	8.43
UFN18-1.75-30EI	1-3/4	2-1/8	0.300	8.31
UFN18-2.12-31EI	2-1/8	2-1/2	5/16	9.89
7/32" C/S				
UFN22-1.12-34EI	1-1/8	1-9/16	0.340	\$ 6.72
1/4" C/S				
UFN25-0.87-25EI	7/8	1-3/8	1/4	\$ 8.98
UFN25-1.00-25EI	1	1-1/2	1/4	7.51

Part Number	I.D.	O.D.	H.	List Price
1/4" C/S				
UFN25-1.00-37EI	1	1-1/2	3/8	\$ 6.50
UFN25-1.12-37EI	1-1/8	1-5/8	3/8	6.72
UFN25-1.25-37EI	1-1/4	1-3/4	3/8	8.31
UFN25-1.50-37EI	1-1/2	2	3/8	7.15
UFN25-1.50-46EI	1-1/2	2	0.460	7.15
UFN25-1.75-37EI	1-3/4	2-1/4	3/8	6.82
UFN25-2.00-37EI	2	2-1/2	3/8	9.79
UFN25-2.25-37EI	2-1/4	2-3/4	3/8	9.55
UFN25-2.50-31EI	2-1/2	3	5/16	11.82
UFN25-3.50-37EI	3-1/2	4	3/8	22.19
5/16" C/S				
UFN31-1.25-43EI	1-1/4	1-7/8	7/16	\$ 8.65
UFN31-1.50-43EI	1-1/2	2-1/8	7/16	8.31
UFN31-1.75-43EI	1-3/4	2-3/8	7/16	9.43
UFN31-2.00-43EI	2	2-5/8	7/16	10.11
11/32" C/S				
UFN34-1.50-43EI	1-1/2	1.032	7/16	\$ 9.10
3/8" C/S				
UFN37-2.50-56EI	2-1/2	3-1/4	9/16	\$ 12.30
UFN37-2.75-56EI	2-3/4	3-1/2	9/16	16.86
UFN37-3.00-56EI	3	3-3/4	9/16	15.70
UFN37-3.50-56EI	3-1/2	4-1/4	9/16	21.28

STYLE UFN-BR ROD U-SEALS W/HEADERS

This is a single acting rod seal designed for low and high pressure sealing and is commonly found in telescopic cylinders. The seal consists of a molded rubber sealing lip, rubberized fabric heel, and a polyester header for improved extrusion resistance.

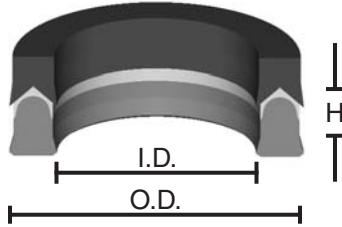

SEAL INFORMATION	
MATERIAL	RUBBER, FABRIC, POLYESTER ELASTOMER
TEMPERATURE RANGE	-22° TO +212° F
PRESSURE RANGE	1.64 FPS @ 3600 PSI 0.49 FPS @ 5800 PSI
PART NUMBER	(Prefix)(CS) - (Inside Dia) - (Height)

Part Number	I.D.	O.D.	H.	List Price
UFN22-2.75-75BR-L-F	2-3/4	3.200	3/4	\$ 20.98
UFN25-3.50-75BR-L-F	3-1/2	4.013	3/4	23.28
UFN25-4.37-75BR-L-F	4-3/8	4-7/8	3/4	27.55
UFN28-6.31-75BR-L-F	6-5/16	6-7/8	3/4	48.92

Part Number	I.D.	O.D.	H.	List Price
UFN31-8.37-75BR-L-F	8-3/8	9	3/4	\$ 113.16
UFN32-7.31-75BR-L-F	7-5/16	7.954	3/4	66.46
UFN39-9.43-100BR-L-F	9-7/16	10.216	1	184.98

STYLE UFN-EI-SAG ROD SEALS W/BACK-UP RINGS

This is a single acting rod seal designed for low and high pressure sealing and is commonly found in telescopic cylinders. The seal consists of a molded rubber sealing lip, rubberized fabric heel, and an acetal back-up ring for improved extrusion resistance.

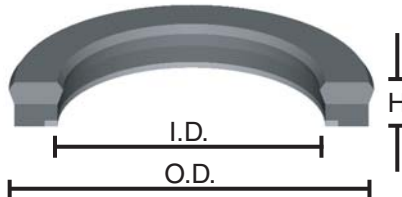

SEAL INFORMATION	
MATERIAL	RUBBER, FABRIC, ACETAL
TEMPERATURE RANGE	-22° TO +212° F
PRESSURE RANGE	1.64 FPS @ 3600 PSI 0.49 FPS @ 5800 PSI
PART NUMBER	(Prefix)(CS) - (Inside Dia) - (Height)

Part Number	I.D.	O.D.	H.	List Price
UFN21-2.00-41EI-SAG-F	2	2-7/16	0.406	\$ 30.01
UFN21-2.75-41EI-SAG-F	2-3/4	3-3/16	0.406	48.23
UFN25-3.50-46EI-SAG-F	3-1/2	4	0.468	48.64

Part Number	I.D.	O.D.	H.	List Price
UFN25-4.37-46EI-SAG-F	4-3/8	4-7/8	0.468	\$ 77.55
UFN31-5.25-46EI-SAG-F	5-1/4	5-7/8	0.468	111.40

STYLE UFN-WI ROD SEAL W/CLIP ON BEARING

This is a single acting rod seal designed for low and high pressure sealing and is commonly found in telescopic cylinders. The seal consists of a molded rubber sealing lip and rubberized fabric heel. It also incorporates an acetal wear ring for improved extrusion resistance and to allow larger clearances between the rod and gland.

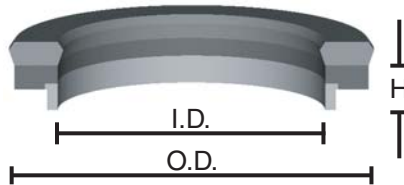

SEAL INFORMATION	
MATERIAL	RUBBER, FABRIC, ACETAL
TEMPERATURE RANGE	-22° TO +212° F
PRESSURE RANGE	1.64 FPS @ 3600PSI 0.49 FPS @ 5800PSI
PART NUMBER	(Prefix)(CS) - (Inside Dia) - (Height)

Part Number	I.D.	O.D.	H.	List Price
UFN37-3.00-56WI-S-F	3	3-3/4	9/16	\$ 29.18
UFN37-3.62-56WI-S-F	3-5/8	4-3/8	9/16	29.47
UFN37-4.37-56WI-S-F	4-3/8	5-1/8	9/16	40.96
UFN37-5.25-56WI-S-F	5-1/4	6	9/16	48.92

Part Number	I.D.	O.D.	H.	List Price
UFN37-6.31-56WI-S-F	6-5/16	7-1/16	9/16	\$ 71.39
UFN37-7.31-56WI-S-F	7-5/16	8-5/16	9/16	88.37
UFN50-8.37-68WI-S-F	8-3/8	9-3/8	11/16	105.51

STYLE HMU POLYURETHANE U-SEALS

The HMU style multi-lip rod u-seal combines the pressure-compensating, uni-directional characteristics of a u-seal with the multi-lip sealing effectiveness of compression-type stacked-packings. Made from premium materials, the HMU utilizes several sealing lip edges for dry rod performance while minimizing friction. The multi-lip design maintains a critical sealing edge even though increasing pressure moves the line of contact down toward the heel.

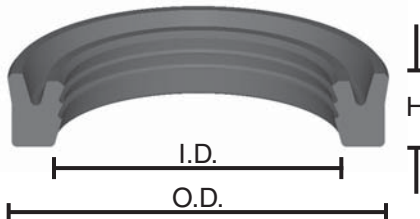

SEAL INFORMATION	
MATERIAL	92A URETHANE
TEMPERATURE RANGE	-40° TO +200° F
PRESSURE RANGE	0 TO 5,000 PSI
PART NUMBER	(Prefix)(CS) - (Inside Dia) - (Height)

Part Number	I.D.	O.D.	H.	List Price
1/8" C/S				
HMU12-0.62-17U	5/8	7/8	.17	\$ 4.21
HMU12-0.50-21U	1/2	3/4	7/32	12.71
HMU12-0.62-21U	5/8	7/8	7/32	13.12
HMU12-1.00-25U	1	1-1/4	1/4	4.69
5/32" C/S				
HMU15-1.00-21U	1	1-5/16	7/32	\$ 16.03
HMU15-1.37-24U	1-3/8	1-11/16	0.24	18.92
3/16" C/S				
HMU18-1.37-31U	1-3/8	1-3/4	5/16	\$ 5.57
HMU18-1.75-27U	1-3/4	2-1/8	0.27	22.52
HMU18-1.75-38U	1-3/4	2-1/8	3/8	6.26
HMU18-2.00-27U	2	2-3/8	0.27	26.15
HMU18-2.00-38U	2	2-3/8	3/8	7.14
HMU18-2.50-38U	2-1/2	2-7/8	3/8	7.54

Part Number	I.D.	O.D.	H.	List Price
3/16" C/S				
HMU18-3.00-38U	3	3-3/8	3/8	\$ 8.08
HMU18-3.50-38U	3-1/2	3-7/8	3/8	10.24
7/32" C/S				
HMU21-2.50-30U	2-1/2	2.93	0.30	\$ 27.57
HMU21-3.00-30U	3	3-7/16	0.30	29.02
1/4" C/S				
HMU25-3.50-33U	3-1/2	4	0.33	\$ 34.49
HMU25-4.00-33U	4	4-1/2	0.33	38.57
HMU25-4.50-33U	4-1/2	5	0.33	42.66
9/32" C/S				
HMU28-5.00-35U	5	5-9/16	0.355	\$ 46.75
5/16" C/S				
HMU31-5.50-38U	5-1/2	6.12	0.38	\$ 51.80

STYLE HMU HOMOGENOUS U-SEALS

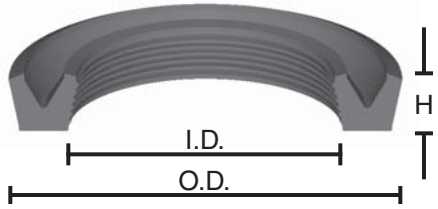

N=BUNA-N
V=FLUOROCARBON

SEAL INFORMATION

MATERIAL	80A BUNA-N RUBBER 90A FLUOROCARBON
TEMPERATURE RANGE	BUNA-N: -40° TO +250° F FC: -20° TO +400° F
PRESSURE RANGE	BUNA-N: 0 TO 1,000 PSI FC: 0-2,000 PSI
PART NUMBER	(Prefix)(CS) - (Inside Dia) - (Height)

Part Number	I.D.	O.D.	H.	List Price
1/8" C/S				
HMU12-0.62-15N	5/8	7/8	5/32	\$ 6.90
HMU12-0.62-15V	5/8	7/8	5/32	24.88
5/32" C/S				
HMU15-1.00-18N	1	1-5/16	3/16	\$ 6.59
HMU15-1.00-18V	1	1-5/16	3/16	12.65
HMU15-1.37-18N	1-3/8	1-11/16	3/16	8.82
HMU15-1.37-18V	1-3/8	1-11/16	3/16	26.17

Part Number	I.D.	O.D.	H.	List Price
3/16" C/S				
HMU18-1.75-21N	1-3/4	2-1/8	7/32	\$ 9.70
HMU18-1.75-21V	1-3/4	2-1/8	7/32	32.96
HMU18-2.00-21N	2	2-3/8	7/32	11.67
HMU18-2.00-21V	2	2-3/8	7/32	37.67
7/32" C/S				
HMU21-2.50-24N	2-1/2	2.93	.24	\$ 13.15
HMU21-2.50-24V	2-1/2	2.93	.24	44.30
HMU21-3.00-24N	3	3-7/16	.24	15.79
HMU21-3.00-24V	3	3-7/16	.24	53.16

STYLE UKR ROD U-SEALS

UKR u-seals are designed to act as a positive sealing, low friction replacement for conventional rubber u-seals. Molded from polyurethane, UKR u-seals provide long life and high resistance against extrusion. Low friction allows these seals to run smoothly in a lubricated or non-lubricated cylinder. Available for rod sealing, the flexible dynamic lip provides very low breakaway friction and steady motion.

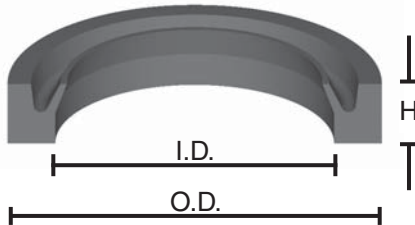

SEAL INFORMATION

MATERIAL	90A URETHANE
TEMPERATURE RANGE	-40° TO +200° F
PRESSURE RANGE	0 TO 150 PSI
PART NUMBER	(Prefix)(CS) - (Inside Dia)

Part Number	I.D.	O.D.	H.	List Price
3/32" C/S				
UKR09-0.25	1/4	7/16	3/32	\$ 3.29
UKR09-0.31	5/16	1/2	3/32	3.29
UKR09-0.50	1/2	11/16	3/32	3.29
1/8" C/S				
UKR12-0.37	3/8	5/8	1/8	\$ 4.49
UKR12-0.50	1/2	3/4	1/8	4.49
UKR12-0.62	5/8	7/8	1/8	4.57
UKR12-0.75	3/4	1	1/8	4.57
UKR12-0.87	7/8	1-1/8	1/8	4.64

Part Number	I.D.	O.D.	H.	List Price
UKR12-1.00	1	1-1/4	1/8	\$ 4.64
UKR12-1.12	1-1/8	1-3/8	1/8	4.68
5/32" C/S				
UKR15-1.00	1	1-5/16	5/32	\$ 4.89
UKR15-1.25	1-1/4	1-9/16	5/32	4.89
UKR15-1.37	1-3/8	1-11/16	5/32	4.89
3/16" C/S				
UKR18-1.50	1-1/2	1-7/8	3/16	\$ 5.17
UKR18-1.75	1-3/4	2-1/8	3/16	5.27
UKR18-2.00	2	2-3/8	3/16	5.17
UKR18-2.25	2-1/4	2-5/8	3/16	5.48