



HYDRO-LINE®

Kit Type		Page
A5 Series	Rod Kits	22
	Piston Kits	23
	Tube End Seals	23
E2 Series	Rod Kits	24
	Piston Kits	24
	Tube End Seals	24
N2 Series	Rod Kits	25
	Piston Kits	26
	Tube End Seals	27
N5 Series	Rod Kits	28 - 29
	Piston Kits	30
	Tube End Seals	30
R2 Series	Rod Kits	31
	Piston Kits	32
	Tube End Seals	33
R5 Series	Rod Kits	34 - 35
	Piston Kits	36
	Tube End Seals	37
Universal Kits	Rod Kits	38
	Gland Kits	39 - 40
	Captive Cushion Adjustment Seal	41
	Piston Kits	42
Repair Kits	By Part Number	43 - 49

HYDRO-LINE®

A5 Series Rod Kits

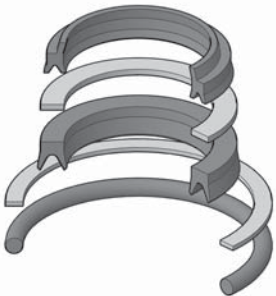
HYDRO-LINE®

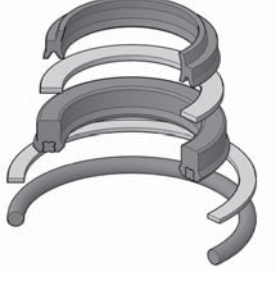
		A5 Cylinders		HA5 Cylinders				
		Nitrile	Fluorocarbon	Urethane	Fluorocarbon			
								
		Kit Includes: 1 XNBR Wiper 1 URE Back-up Ring 1 NBR U-seal 1 PTFE Back-up Ring 1 NBR O-ring	Kit Includes: 1 FC Wiper 1 PTFE Back-up Ring 1 FC U-seal 1 PTFE Back-up Ring 1 FC O-ring	Kit Includes: 1 XNBR Wiper 1 URE U-seal 1 PTFE Back-up Ring 1 NBR O-ring	Kit Includes: 1 FC Wiper 1 PTFE Back-up Ring 1 FC Loaded U-seal 1 PTFE Back-up Ring 1 FC O-ring			
Rod Dia.	(NBR) Kit #	List Price	(FC) Kit #	List Price	(URE) Kit #	List Price	(FC) Kit #	List Price
5/8"	HSKN5-660-05	\$ 9.65	HSKN5-660-05V	\$ 34.64	HSKN5-681-05	\$ 16.25	HSKN5-660-P-05V	\$ 58.27
1"	HSKN5-660-08	9.81	HSKN5-660-08V	36.40	HSKN5-681-08	17.83	HSKN5-660-P-08V	66.15
1-3/8"	HSKN5-660-11	12.30	HSKN5-660-11V	47.57	HSKN5-681-11	19.87	HSKN5-660-P-11V	81.05

HYDRO-LINE®

A5 Series Piston Kits

A5 Cylinders

Nitrile



Kit Includes:
2 NBR U-seals
2 PTFE Tube End Seals

Fluorocarbon



Kit Includes:
2 FC U-seals
2 PTFE Tube End Seals

Bore Dia.	(NBR) Kit #	List Price	(FC) Kit #	List Price
1-1/2"	HSKA5-512-03	\$ 25.39	HSKA5-512-03V	\$ 51.36
2"	HSKA5-512-04	27.05	HSKA5-512-04V	53.22
2-1/2"	HSKA5-512-05	29.14	HSKA5-512-05V	62.76
3-1/4"	HSKA5-512-065	31.43	HSKA5-512-065V	70.77
4"	HSKA5-512-08	36.59	HSKA5-512-08V	76.93
5"	HSKA5-512-10	45.72	HSKA5-512-10V	90.22
6"	HSKA5-512-12	53.84	HSKA5-512-12V	147.63

Tube End Seals

A5 Cylinders PTFE

Bore Dia.	Part #	List Price
1-1/2"	HS-C221-03	\$ 8.67
2"	HS-C221-04	9.44
2-1/2"	HS-C221-05	10.42
3-1/4"	HS-C221-065	11.24
4"	HS-C221-08	12.69
5"	HS-C221-10	17.17
6"	HS-C221-12	22.10



HYDRO-LINE®

HYDRO-LINE®

E2 Series Rod Kits

E2 Cylinders Nitrile

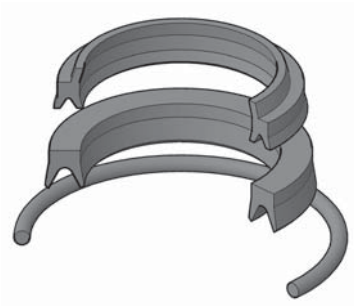

Rod Dia.	(NBR) Kit #	List Price
5/8"	HSKE2-660-05	\$ 4.28
1"	HSKE2-660-08	4.76
1-3/8"	HSKE2-660-11	5.29

Kit Includes:
 1 XNBR Wiper
 1 NBR U-seal
 1 NBR O-ring

Piston Kits

E2 Cylinders Nitrile

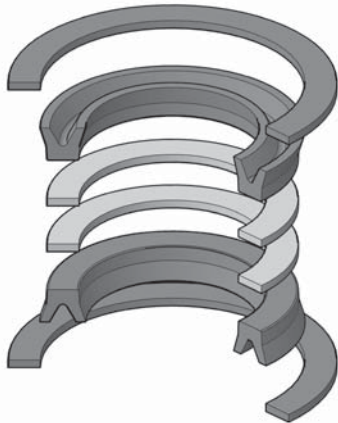

Bore Dia.	(NBR) Kit #	List Price
2"	HSKE2-512-04	\$ 25.76
3-1/4"	HSKE2-512-065	24.76
4"	HSKE2-512-08	43.20

Kit Includes:
 2 NBR U-seals
 2 PTFE Back-up Rings (found in 2" & 4" Bore Kits Only)
 2 Fiber Gaskets

Tube End Seals

E2 Cylinders Fiber

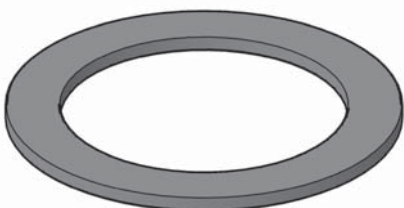

Bore Dia.	Part #	List Price
1-1/2"	HS-E304-03	\$ 2.52
2"	HS-E304-04	2.63
3-1/4"	HS-E304-065	2.94
4"	HS-E304-08	3.32

HYDRO-LINE®

N2 Series Rod Kits

N2 Cylinders

Nitrile

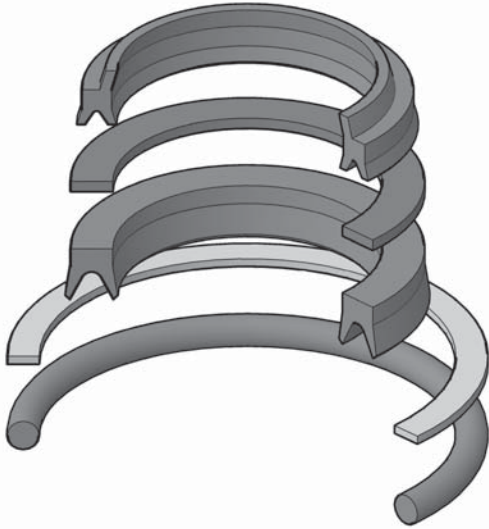

- Kit Includes:**
 1 XNBR Wiper
 1 URE Back-up Ring
 1 NBR U-seal
 1 PTFE Back-up Ring
 1 NBR O-ring

Fluorocarbon

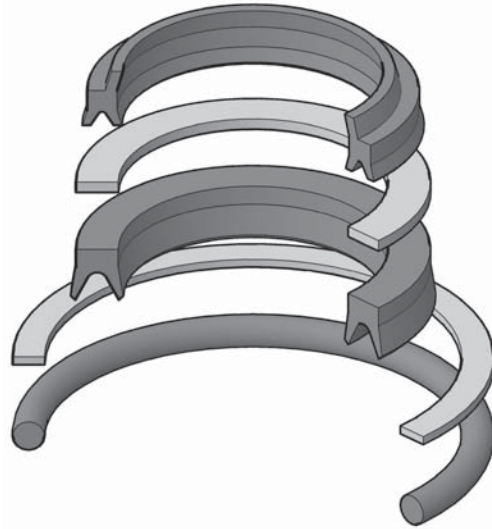

- Kit Includes:**
 1 FC Wiper
 1 PTFE Back-up Ring
 1 FC U-seal
 1 PTFE Back-up Ring
 1 FC O-ring

Rod Dia.	(NBR) Kit #	List Price	(FC) Kit #	List Price
5/8"	HSKN2-661-05	\$ 9.68	HSKN2-661-05V	\$ 35.85
1"	HSKN2-661-08	9.61	HSKN2-661-08V	38.06
1-3/8"	HSKN2-661-11	11.73	HSKN2-661-11V	42.40
1-3/4"	HSKN2-661-14	13.78	HSKN2-661-14V	49.71
2"	HSKN2-661-16	15.26	HSKN2-661-16V	52.49
2-1/2"	HSKN2-661-20	22.89	HSKN2-661-20V	58.58
3"	HSKN5-660-24	19.87	HSKN5-660-24V	77.34
3-1/2"	HSKN5-660-28	21.80	HSKN5-660-28V	90.36
4"	HSKN5-660-32	27.35	HSKN5-660-32V	94.43
4-1/2"	HSKN5-660-36	29.46	HSKN5-660-36V	99.68
5"	HSKN5-660-40	43.61	HSKN5-660-40V	119.83
5-1/2"	HSKN5-660-44	59.46	HSKN5-660-44V	135.32

HYDRO-LINE®

HYDRO-LINE®

N2 Series Piston Kits

Nitrile

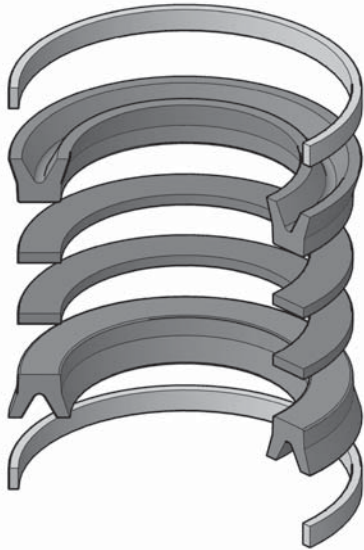

Kit Includes:

- 2 NBR U-seals
- 2 URE Back-up Rings
- 2 PTFE Tube End Seals

N2 Cylinders Fluorocarbon

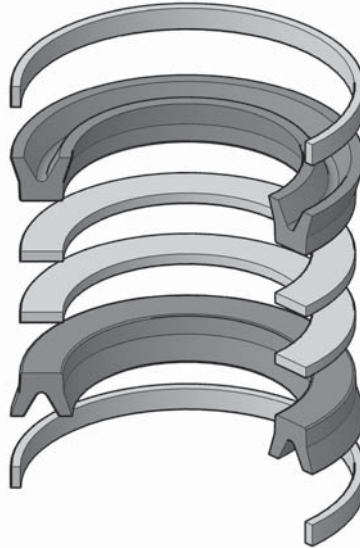

Kit Includes:

- 2 FC U-seals
- 2 PTFE Back-up Rings
- 2 PTFE Tube End Seals

Piston Ring

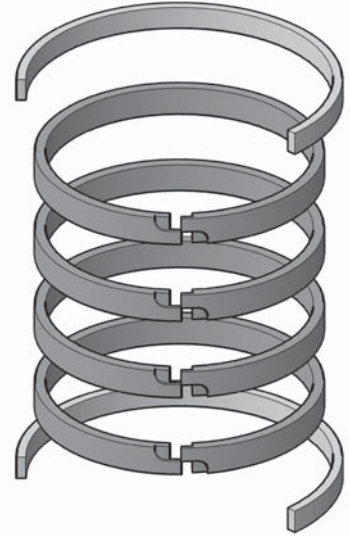

Kit Includes:

- 4 Cast-Iron Piston Rings
- 2 PTFE Tube End Seals

Bore Dia.	(NBR) Kit #	List Price	(FC) Kit #	List Price	(PR) Kit #	List Price
1-1/2"	HSKN2-512-03	\$ 32.41	HSKN2-512-03V	\$ 63.08	HSKN2-511-03	\$ 80.46
2"	HSKN2-512-04	39.28	HSKN2-512-04V	82.82	HSKN2-511-04	91.74
2-1/2"	HSKN2-512-05	42.40	HSKN2-512-05V	88.04	HSKN2-511-05	93.22
3-1/4"	HSKN2-512-065	40.75	HSKN2-512-065V	100.07	HSKN2-511-065	98.40
4"	HSKN2-512-08	48.96	HSKN2-512-08V	118.37	HSKN2-511-08	110.77
5"	HSKN2-512-10	62.90	HSKN2-512-10V	131.08	HSKN2-511-10	134.80
6"	HSKN2-512-12	70.69	HSKN2-512-12V	174.14	HSKN2-511-12	142.37
7"	HSKN2-512-14	107.93	HSKN2-512-14V	256.51	HSKN2-511-14	159.46
8"	HSKN2-512-16	136.69	HSKN2-512-16V	283.36	HSKN2-511-16	196.06
10"	HSKN2-512-20	153.71	HSKN2-512-20V	527.14	HSKN2-511-20	409.45
12"	HSKN2-512-24	241.61	HSKN2-512-24V	781.58	HSKN2-511-24	553.86

HYDRO-LINE®

N2 Series Tube End Seals

N2 Cylinders PTFE

Bore Dia.	Part #	List Price
1-1/2"	HS-C124-03	\$ 10.66
2"	HS-C124-04	12.96
2-1/2"	HS-C124-05	15.00
3-1/4"	HS-C124-065	18.98
4"	HS-C124-08	20.40
5"	HS-C124-10	22.45
6"	HS-C124-12	23.18
7" & UP	HS-C124-STRIP (sold by the foot)	15.07

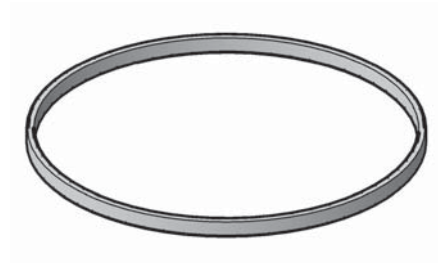

HYDRO-LINE®

N5 Series Rod Kits

N5 & AN5 Cylinders Nitrile

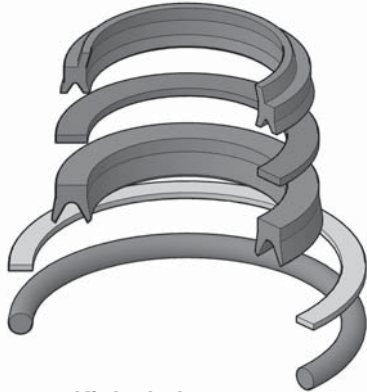

Kit Includes:

- 1 XNBR Wiper
- 1 URE Back-up Ring
- 1 NBR U-seal
- 1 PTFE Back-up Ring
- 1 NBR O-ring

Rod Dia.	(NBR) Kit #	List Price
5/8"	HSKN5-660-05	\$ 9.65
1"	HSKN5-660-08	9.81
1-3/8"	HSKN5-660-11	12.30
1-3/4"	HSKN5-660-14	15.51
2"	HSKN5-660-16	17.37
2-1/2"	HSKN5-660-20	19.11
3"	HSKN5-660-24	19.87
3-1/2"	HSKN5-660-28	21.80
4"	HSKN5-660-32	27.35
4-1/2"	HSKN5-660-36	29.46
5"	HSKN5-660-40	43.61
5-1/2"	HSKN5-660-44	59.46

Rod Kits

N5 Cylinders Fluorocarbon



Kit Includes:

- 1 FC Wiper
- 1 PTFE Back-up Ring
- 1 FC U-seal
- 1 PTFE Back-up Ring
- 1 FC O-ring

Rod Dia.	(FC) Kit #	List Price
5/8"	HSKN5-660-05V	\$ 34.64
1"	HSKN5-660-08V	36.40
1-3/8"	HSKN5-660-11V	47.57
1-3/4"	HSKN5-660-14V	49.32
2"	HSKN5-660-16V	52.56
2-1/2"	HSKN5-660-20V	59.31
3"	HSKN5-660-24V	77.34
3-1/2"	HSKN5-660-28V	90.36
4"	HSKN5-660-32V	94.43
4-1/2"	HSKN5-660-36V	99.68
5"	HSKN5-660-40V	119.83
5-1/2"	HSKN5-660-44V	135.32

HYDRO-LINE®

N5 Series Rod Kits

N5 Cylinders

Urethane



- Kit Includes:**
 1 XNBR Wiper
 1 URE U-seal
 1 PTFE Back-up Ring
 1 NBR O-ring

Urethane

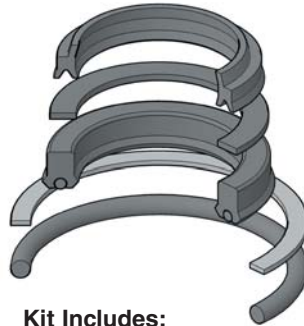

- Kit Includes:**
 1 XNBR Wiper
 1 Urethane Back-up Ring
 1 Urethane Loaded U-seal
 1 PTFE Back-up Ring
 1 NBR O-ring

Fluorocarbon



- Kit Includes:**
 1 FC Wiper
 1 PTFE Back-up Ring
 1 FC Loaded U-seal
 1 PTFE Back-up Ring
 1 FC O-ring

Rod Dia.	(URE) Kit #	List Price	(URE) Kit #	List Price	(FC) Kit #	List Price
1/2"	—		HSKN5-660-P-04	\$ 13.67	—	
5/8"	HSKN5-681-05	\$ 16.25	—		HSKN5-660-P-05V	\$ 58.27
1"	HSKN5-681-08	17.83	HSKN5-660-P-08	15.19	HSKN5-660-P-08V	66.15
1-3/8"	HSKN5-681-11	19.87	—		HSKN5-660-P-11V	81.05
1-3/4"	HSKN5-681-14	21.26	HSKN5-660-P-14	18.85	HSKN5-660-P-14V	89.31
2"	HSKN5-681-16	27.67	—		HSKN5-660-P-16V	93.01
2-1/2"	HSKN5-681-20	38.97	HSKN5-660-P-20	28.37	HSKN5-660-P-20V	135.63
3"	HSKN5-681-24	42.48	—		HSKN5-660-P-24V	156.21
3-1/2"	HSKN5-681-28	46.53	HSKN5-660-P-28	34.89	HSKN5-660-P-28V	174.42
4"	HSKN5-681-32	54.56	—		HSKN5-660-P-32V	210.65
4-1/2"	HSKN5-681-36	71.68	—		HSKN5-660-P-36V	225.92
5"	HSKN5-681-40	75.08	—		HSKN5-660-P-40V	231.60
5-1/2"	HSKN5-681-44	89.34	—		HSKN5-660-P-44V	236.78

HYDRO-LINE®

N5 Series Piston Kits

HYDRO-LINE®

N5 Cylinders

Nitrile



Kit Includes:
2 NBR U-seals
2 URE Back-up Rings
2 PTFE Tube End Seals

Fluorocarbon



Kit Includes:
2 FC U-seals
2 PTFE Back-up Rings
2 PTFE Tube End Seals

Urethane

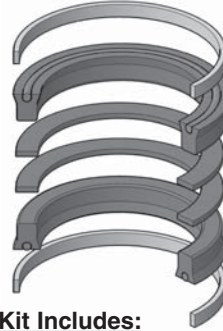

Kit Includes:
2 Urethane U-seals
2 URE Back-up Rings
2 PTFE Tube End Seals

Piston Ring

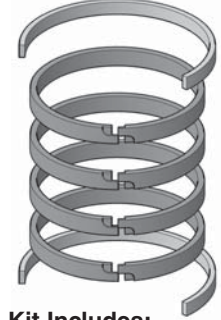

Kit Includes:
4 Cast-Iron Piston Rings
2 PTFE Tube End Seals

Bore Dia.	(NBR) Kit #	List Price	(FC) Kit #	List Price	(URE) Kit #	List Price	(PR) Kit #	List Price
1-1/2"	HSKN5-512-03	\$ 25.19	HSKN5-512-03V	\$ 62.55	—	—	HSKN5-511-03	\$ 79.93
2"	HSKN5-512-04	34.64	HSKN5-512-04V	86.57	—	—	HSKN5-511-04	87.13
2-1/2"	HSKN5-512-05	37.06	HSKN5-512-05V	88.04	HSKN5-512-P-05	\$ 42.20	HSKN5-511-05	87.84
3-1/4"	HSKN5-512-065	40.75	HSKN5-512-065V	91.95	—	—	HSKN5-511-065	90.53
4"	HSKN5-512-08	48.85	HSKN5-512-08V	119.01	—	—	HSKN5-511-08	103.74
5"	HSKN5-512-10	59.57	HSKN5-512-10V	139.75	—	—	HSKN5-511-10	126.28
6"	HSKN5-512-12	61.98	HSKN5-512-12V	165.46	—	—	HSKN5-511-12	142.37
7"	HSKN5-512-14	117.23	HSKN5-512-14V	236.14	—	—	HSKN5-511-14	168.24
8"	HSKN5-512-16	164.44	HSKN5-512-16V	265.88	HSKN5-512-P-16	211.29	HSKN5-511-16	213.50
10"	HSKN2-512-20	153.71	HSKN2-512-20V	527.14	—	—	HSKN2-511-20	409.45
12"	HSKN2-512-24	241.61	HSKN2-512-24V	781.58	—	—	HSKN2-511-24	553.86

Tube End Seals

N5 Cylinders PTFE

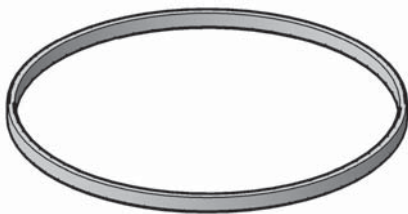

Bore Dia.	Part #	List Price
1-1/2"	HS-C255-03	\$ 11.44
2"	HS-C255-04	13.23
2-1/2"	HS-C255-05	13.96
3-1/4"	HS-C255-065	14.38
4"	HS-C255-08	16.32
5"	HS-C255-10	17.38
6"	HS-C255-12	18.13
7"	HS-C255-14	18.98
8"	HS-C255-16	22.09
10" & UP	HS-C124-STRIP (sold by the foot)	15.07

HYDRO-LINE®

R2 Series Rod Kits

R2 & LR2 Cylinders

Nitrile

Fluor ocarbon

Urethane

Fluor ocarbon



Kit Includes:

- 1 XNBR Wiper
- 1 URE Back-up Ring
- 1 NBR U-seal
- 1 PTFE Back-up Ring
- 1 NBR O-ring



Kit Includes:

- 1 FC Wiper
- 1 PTFE Back-up Ring
- 1 FC U-seal
- 1 PTFE Back-up Ring
- 1 FC O-ring

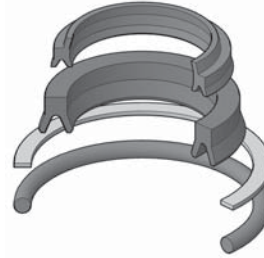

Kit Includes:

- 1 XNBR Wiper
- 1 URE U-seal
- 1 PTFE Back-up Ring
- 1 NBR O-ring

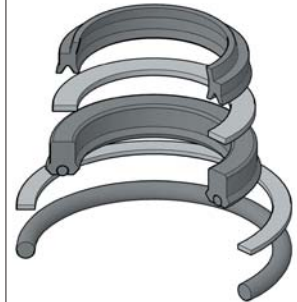

Kit Includes:

- 1 FC Wiper
- 1 PTFE Back-up Ring
- 1 FC Loaded U-seal
- 1 PTFE Back-up Ring
- 1 FC O-ring

Rod Dia.	Bore Dia.	(NBR) Kit #	List Price	(FC) Kit #	List Price	(URE) Kit #	List Price	(FC) Kit #	List Price
5/8"	1"	HSKR2-662-05A	\$ 8.48	HSKR2-662-05AV	\$ 35.77	HSKR2-681-05A	\$ 14.19	HSKR2-662-P-05AV	\$ 55.18
5/8"	1.5" & UP	HSKN2-661-05	9.68	HSKN2-661-05V	35.85	—	—	—	—
1"	1.5", 2, 2.5"	HSKR2-662-08	9.25	HSKR2-662-08V	36.50	HSKR2-681-08	17.61	HSKR2-662-P-08V	66.70
1"	3.25" & UP	HSKN2-661-08	9.61	HSKN2-661-08V	38.06	—	—	—	—
1-3/8"	2", 2.5"	HSKR2-662-11	11.27	HSKR2-662-11V	47.03	HSKR2-681-11	17.83	HSKR2-662-P-11V	80.06
1-3/8"	3.25" & UP	HSKN2-661-11	11.73	HSKN2-661-11V	42.40	—	—	—	—
1-3/4"	2.5"	HSKR2-662-14	13.85	HSKR2-662-14V	48.33	HSKR2-681-14	18.62	HSKR2-662-P-14V	89.65
1-3/4"	3.25" & UP	HSKN2-661-14	13.78	HSKN2-661-14V	49.71	—	—	—	—
2"	ALL	HSKN2-661-16	15.26	HSKN2-661-16V	52.49	—	—	—	—
2-1/2"	ALL	HSKN2-661-20	22.89	HSKN2-661-20V	58.58	—	—	—	—
3"	ALL	HSKN5-660-24	19.87	HSKN5-660-24V	77.34	—	—	—	—
3-1/2"	ALL	HSKN5-660-28	21.80	HSKN5-660-28V	90.36	—	—	—	—
4"	ALL	HSKN5-660-32	27.35	HSKN5-660-32V	94.43	—	—	—	—
4-1/2"	ALL	HSKN5-660-36	29.46	HSKN5-660-36V	99.68	—	—	—	—
5"	ALL	HSKN5-660-40	43.61	HSKN5-660-40V	119.83	—	—	—	—
5-1/2"	ALL	HSKN5-660-44	59.46	HSKN5-660-44V	135.32	—	—	—	—

HYDRO-LINE®

HYDRO-LINE®

R2 Series Piston Kits

Nitrile

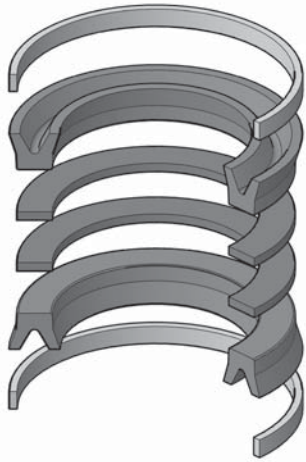

Kit Includes:
 2 NBR U-seals
 2 URE Back-up Rings
 2 PTFE Tube End Seals

R2 & LR2 Cylinder s Fluor ocarbon

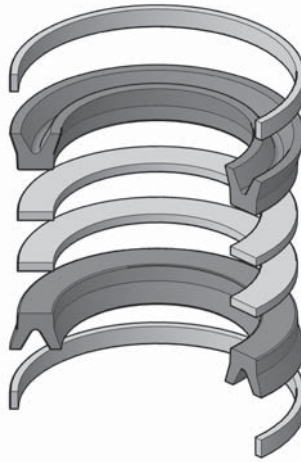

Kit Includes:
 2 FC U-seals
 2 PTFE Back-up Rings
 2 PTFE Tube End Seals

Piston Ring

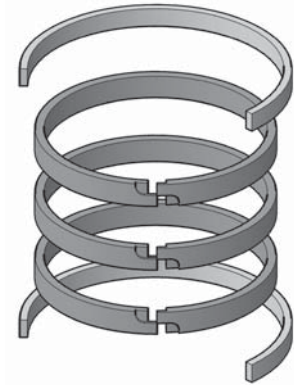

Kit Includes:
 3 Cast-Iron Piston Rings
 2 PTFE Tube End Seals

Bore Dia.	(NBR) Kit #	List Price	(FC) Kit #	List Price	(PR) Kit #	List Price
1"	HSKR5-512-02	\$ 25.99	HSKR5-512-02V	\$ 55.49	HSKR5-511-02	\$ 86.60
1-1/2"	HSKR5-512-03	27.45	HSKR5-512-03V	58.10	HSKR5-511-03	58.10
2"	HSKR5-512-04	30.04	HSKR5-512-04V	81.96	HSKR5-511-04	59.83
2-1/2"	HSKR5-512-05	32.81	HSKR5-512-05V	83.78	HSKR5-511-05	60.81
3-1/4"	HSKR5-512-065	36.40	HSKR5-512-065V	87.67	HSKR5-511-065	70.40
4"	HSKR5-512-08	42.69	HSKR5-512-08V	112.71	HSKR5-511-08	79.35
5"	HSKR5-512-10	54.06	HSKR5-512-10V	125.54	HSKR5-511-10	102.62
6"	HSKR5-512-12	60.33	HSKR5-512-12V	163.82	HSKR5-511-12	113.73
8"	HSKR5-512-16	156.94	HSKR5-512-16V	310.97	HSKR5-511-16	133.88
10"	HSKR5-512-20	153.71	HSKR5-512-20V	527.14	HSKR5-511-20	381.35
12"	HSKR5-512-24	241.61	HSKR5-512-24V	781.58	HSKR5-511-24	530.57
14"	HSKR5-512-28	347.56	HSKR5-512-28V	852.74	—	

HYDRO-LINE®

R2 Series Tube End Seals

R2 & LR2 Cylinders PTFE

Bore Dia.	Part #	List Price
1"	HS-C221-02	\$ 8.09
1-1/2"	HS-C221-03	8.67
2"	HS-C221-04	9.44
2-1/2"	HS-C221-05	10.42
3-1/4"	HS-C221-065	11.24
4"	HS-C221-08	12.69
5"	HS-C221-10	17.17
6"	HS-C221-12	22.10
8" & UP	HS-C221-STRIP (sold by the foot)	9.70

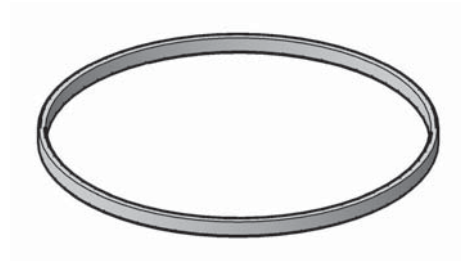

HYDRO-LINE®

R5 Series Rod Kits

R5 & HR5 Cylinders Nitrile

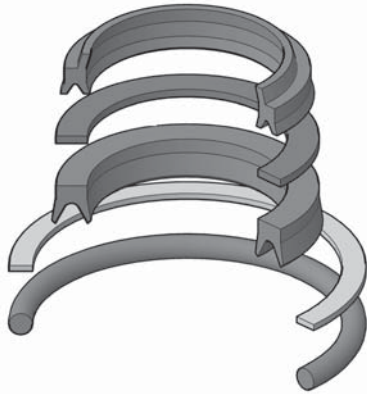

Kit Includes:

- 1 XNBR Wiper
- 1 URE Back-up Ring
- 1 NBR U-seal
- 1 PTFE Back-up Ring
- 1 NBR O-ring

Rod Dia.	Bore Dia.	(NBR) Kit #	List Price
1/2"	1"	HSKN5-660-04	\$ 7.88
5/8"	1"	HSKR2-662-05A	8.48
5/8"	1.5" & UP	HSKN5-660-05	9.65
1"	2" & UP	HSKN5-660-08	9.81
1-3/8"	2.5" & UP	HSKN5-660-11	12.30
1-3/4"	ALL	HSKN5-660-14	15.51
2"	ALL	HSKN5-660-16	17.37
2-1/2"	ALL	HSKN5-660-20	19.11
3"	ALL	HSKN5-660-24	19.87
3-1/2"	ALL	HSKN5-660-28	21.80
4"	ALL	HSKN5-660-32	27.35
4-1/2"	ALL	HSKN5-660-36	29.46
5"	ALL	HSKN5-660-40	43.61
5-1/2"	ALL	HSKN5-660-44	59.46

HYDRO-LINE®

R5 Series Rod Kits

HR5 Cylinders

Fluorocarbon

Urethane

Urethane

Fluorocarbon



Kit Includes:

- 1 FC Wiper
- 1 PTFE Back-up Ring
- 1 FC U-seal
- 1 PTFE Back-up Ring
- 1 FC O-ring

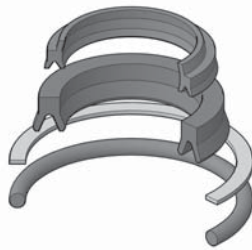

Kit Includes:

- 1 XNBR Wiper
- 1 URE U-seal
- 1 PTFE Back-up Ring
- 1 NBR O-ring



Kit Includes:

- 1 XNBR Wiper
- 1 Urethane Back-up Ring
- 1 Urethane Loaded U-seal
- 1 PTFE Back-up Ring
- 1 NBR O-ring

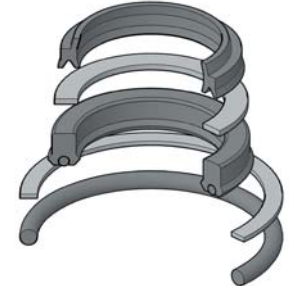

Kit Includes:

- 1 FC Wiper
- 1 PTFE Back-up Ring
- 1 FC Loaded U-seal
- 1 PTFE Back-up Ring
- 1 FC O-ring

Rod Dia.	Bore Dia.	(FC) Kit #	List Price	(URE) Kit #	List Price	(URE) Kit #	List Price	(FC) Kit #	List Price
1/2"	1"	HSKN5-660-04V	\$ 29.02	—	—	HSKN5-660-P-04	\$ 13.67	HSKN5-660-P-04V	\$ 54.83
5/8"	1"	HSKR2-662-05AV	35.77	HSKN5-681-05A	\$ 14.19	—	—	HSKN5-660-P-05AV	55.19
5/8"	1.5" & UP	HSKN5-660-05V	34.64	HSKN5-681-05	16.25	—	—	HSKN5-660-P-05V	58.27
1"	2" & UP	HSKN5-660-08V	36.40	HSKN5-681-08	17.83	HSKN5-660-P-08	15.19	HSKN5-660-P-08V	66.15
1-3/8"	2.5" & UP	HSKN5-660-11V	47.57	HSKN5-681-11	19.87	—	—	HSKN5-660-P-11V	81.05
1-3/4"	ALL	HSKN5-660-14V	49.32	HSKN5-681-14	21.26	HSKN5-660-P-14	18.85	HSKN5-660-P-14V	89.31
2"	ALL	HSKN5-660-16V	52.56	HSKN5-681-16	27.67	—	—	HSKN5-660-P-16V	93.01
2-1/2"	ALL	HSKN5-660-20V	59.31	HSKN5-681-20	38.97	—	—	HSKN5-660-P-20V	135.63
3"	ALL	HSKN5-660-24V	77.34	HSKN5-681-24	42.48	—	—	HSKN5-660-P-24V	156.21
3-1/2"	ALL	HSKN5-660-28V	90.36	HSKN5-681-28	46.53	HSKN5-660-P-28	34.89	HSKN5-660-P-28V	174.42
4"	ALL	HSKN5-660-32V	94.43	HSKN5-681-32	54.56	—	—	HSKN5-660-P-32V	210.65
4-1/2"	ALL	HSKN5-660-36V	99.68	HSKN5-681-36	71.68	—	—	HSKN5-660-P-36V	225.92
5"	ALL	HSKN5-660-40V	119.83	HSKN5-681-40	75.08	—	—	HSKN5-660-P-40V	231.60
5-1/2"	ALL	HSKN5-660-44V	135.32	HSKN5-681-44	89.34	—	—	HSKN5-660-P-44V	236.78

HYDRO-LINE®

HYDRO-LINE®

R5 Series Piston Kits

Nitrile

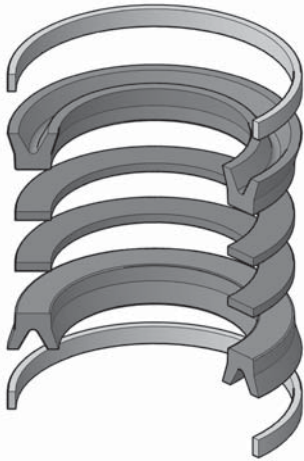

Kit Includes:
 2 NBR U-seals
 2 URE Back-up Rings
 2 PTFE Tube End Seals

R5 Cylinder s Fluor ocarbon

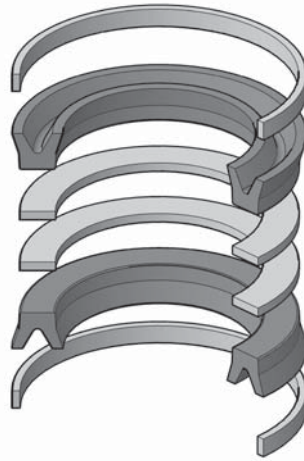

Kit Includes:
 2 FC U-seals
 2 PTFE Back-up Rings
 2 PTFE Tube End Seals

Piston Ring

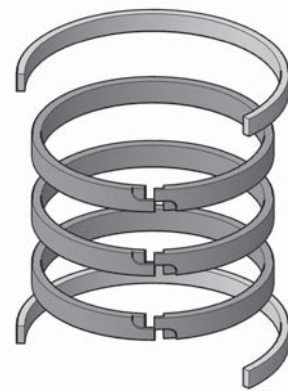

Kit Includes:
 3 Cast-Iron Piston Rings
 2 PTFE Tube End Seals

Bore Dia.	(NBR) Kit #	List Price	(FC) Kit #	List Price	(PR) Kit #	List Price
1"	HSKR5-512-02	\$ 25.99	HSKR5-512-02V	\$ 55.49	HSKR5-511-02	\$ 86.60
1-1/2"	HSKR5-512-03	27.45	HSKR5-512-03V	58.10	HSKR5-511-03	58.10
2"	HSKR5-512-04	30.04	HSKR5-512-04V	81.96	HSKR5-511-04	59.83
2-1/2"	HSKR5-512-05	32.81	HSKR5-512-05V	83.78	HSKR5-511-05	60.81
3-1/4"	HSKR5-512-065	36.40	HSKR5-512-065V	87.67	HSKR5-511-065	70.40
4"	HSKR5-512-08	42.69	HSKR5-512-08V	112.71	HSKR5-511-08	79.35
5"	HSKR5-512-10	54.06	HSKR5-512-10V	125.54	HSKR5-511-10	102.62
6"	HSKR5-512-12	60.33	HSKR5-512-12V	163.82	HSKR5-511-12	113.73
8"	HSKR5-512-16	156.94	HSKR5-512-16V	310.97	HSKR5-511-16	133.88
10"	HSKR5-512-20	153.71	HSKR5-512-20V	527.14	HSKR5-511-20	381.35
12"	HSKR5-512-24	241.61	HSKR5-512-24V	781.58	HSKR5-511-24	530.57
14"	HSKR5-512-28	347.56	HSKR5-512-28V	852.74	—	—

HYDRO-LINE®

R5 Series Tube End Seals

R5 Cylinders PTFE

Bore Dia.	Part #	List Price
1"	HS-C221-02	\$ 8.09
1-1/2"	HS-C221-03	8.67
2"	HS-C221-04	9.44
2-1/2"	HS-C221-05	10.42
3-1/4"	HS-C221-065	11.24
4"	HS-C221-08	12.69
5"	HS-C221-10	17.17
6"	HS-C221-12	22.10
8" & UP	HS-C221-STRIP (sold by the foot)	9.70

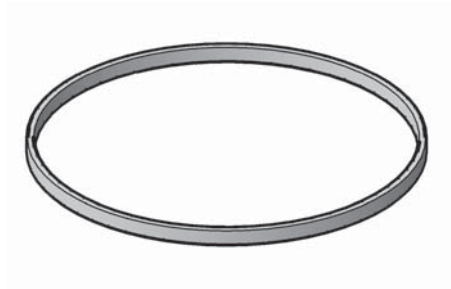

HYDRO-LINE®

UNIVERSAL Rod Kits

A5, N2, N5, R2, & R5 Cylinders (see note)
Nitrile

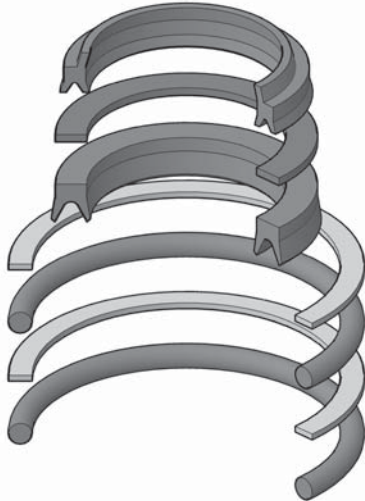

Kit Includes:
1 XNBR Wiper
1 URE Back-up Ring
1 NBR U-seal
2 NBR O-rings
2 PTFE BU Rings

Fluorocarbon

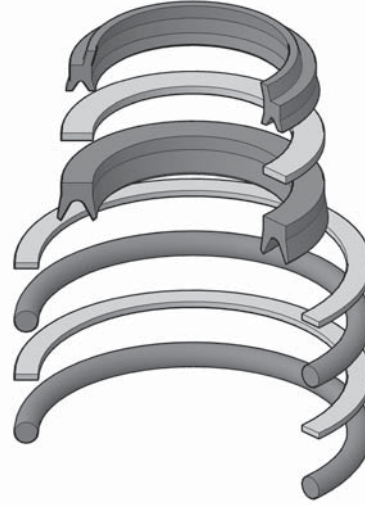

Kit Includes:
1 FC Wiper
1 PTFE BU Ring
1 FC U-seal
2 FC O-rings
2 PTFE BU Rings

Rod Dia.	(NBR) Kit #	List Price	(FC) Kit #	List Price
5/8"	HSKN25-665-05	\$ 11.19	HSKN25-665-05V	\$ 38.80
1"	HSKN25-665-08	11.64	HSKN25-665-08V	40.37
1-3/8"	HSKN25-665-11	14.86	HSKN25-665-11V	51.26
1-3/4"	HSKN25-665-14	18.76	HSKN25-665-14V	57.55
2"	HSKN25-665-16	20.97	HSKN25-665-16V	60.98
2-1/2"	HSKN25-665-20	25.08	HSKN25-665-20V	69.38

Note: Rod Seal Kits are good for all cylinders except R2/R5 1" Bore X All Rods, 1-1/2" Bore X 1" Rod, and 2" Bore X 1-3/8" Rod.

HYDRO-LINE®

UNIVERSAL Gland Kits

A5, N2, N5, R2, & R5 Cylinders (see note)

Nitrile

Fluorocarbon

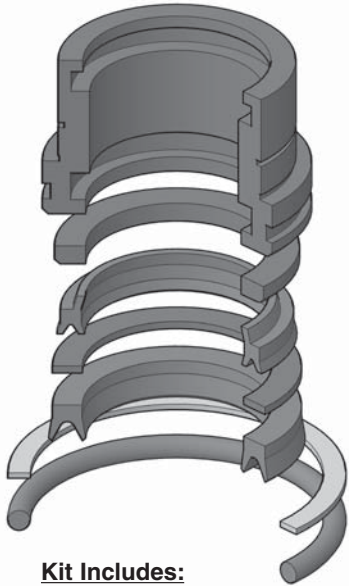

Kit Includes:

- 1 Iron Bushing
- 1 Spacer
- 1 XNBR Wiper
- 1 URE Back-up Ring
- 1 NBR U-seal
- 1 PTFE Back-up ring
- 1 NBR O-ring

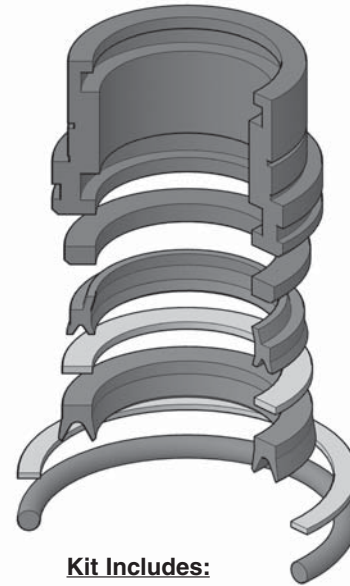

Kit Includes:

- 1 Iron Bushing
- 1 Spacer
- 1 FC Wiper
- 1 PTFE Back-up Ring
- 1 FC U-seal
- 1 PTFE Back-up ring
- 1 FC O-ring

Rod Dia.	(NBR) Kit #	List Price	(FC) Kit #	List Price
5/8"	HN5-665-05	\$ 129.71	HN5-665-05V	\$ 147.85
1"	HN5-665-08	161.01	HN5-665-08V	180.68
1-3/8"	HN5-665-11	172.24	HN5-665-11V	197.52
1-3/4"	HN5-665-14	200.26	HN5-665-14V	225.79
2"	HN5-665-16	208.51	HN5-665-16V	238.51
2-1/2"	HN5-665-20	226.29	HN5-665-20V	259.06
3"	HN5-665-24	340.90	HN5-665-24V	397.62
3-1/2"	HN5-665-28	399.11	HN5-665-28V	449.98
4"	HN5-665-32	442.35	HN5-665-32V	511.77
4-1/2"	HN5-665-36 (2.57" HGT)	626.11	HN5-665-36V (2.57" HGT)	699.61
4-1/2"	HN5-665-36A (1.88" HGT)	626.11	HN5-665-36AV (1.88" HGT)	699.61
5"	HN5-665-40	753.39	HN5-665-40V	846.77
5-1/2"	HN5-665-44	817.54	HN5-665-44V	939.02

**Note: Gland Seal Kits are good for all cylinders with some exceptions.
Call with series, rod & bore size for more information.**

HYDRO-LINE®

UNIVERSAL Gland Kits

A5, N2, N5, R2, & R5 Cylinders (see note)

Iron Bushing

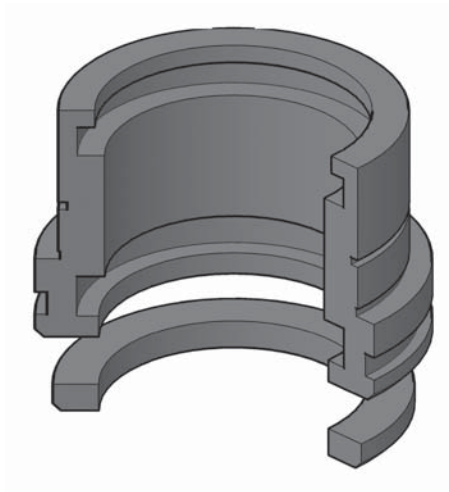

Kit Includes:
1 Iron Bushing
1 Spacer

Bronze Bushing

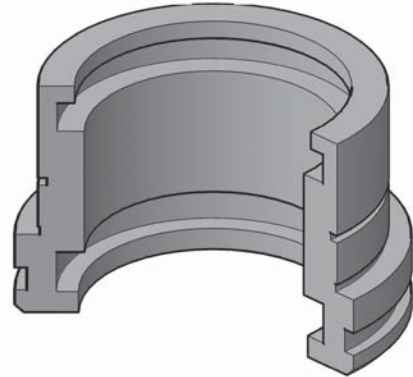

Kit Includes:
1 Bronze Bushing

Rod Dia.	Part #	List Price	Part #	List Price
5/8"	HN5-655-05	\$ 114.74	HN5-B-650-05	\$ 112.20
1"	HN5-655-08	144.43	HN5-B-650-08	120.22
1-3/8"	HN5-655-11	153.87	HN5-B-650-11	141.53
1-3/4"	HN5-655-14	177.46	HN5-B-650-14	163.30
2"	HN5-655-16	185.50	HN5-B-650-16	168.86
2-1/2"	HN5-655-20	199.70	HN5-B-650-20	212.73
3"	HN5-655-24	297.37	HN5-B-650-24	226.63
3-1/2"	HN5-655-28	348.35	HN5-B-650-28	402.16
4"	HN5-655-32	382.32	HN5-B-650-32	432.27
4-1/2"	HN5-655-36 (2.57" HGT)	543.76	HN5-B-650-36 (2.57" HGT)	595.58
4-1/2"	HN5-655-36A (1.88" HGT)	543.76	HN5-B-650-36A (1.88" HGT)	468.58
5"	HN5-655-40	662.69	HN5-B-650-40	654.37
5-1/2"	HN5-655-44	713.68	HN5-B-650-44	683.13

**Note: Gland Seal Kits are good for all cylinders with some exceptions.
Call with series, rod & bore size for more information.**

HYDRO-LINE®

UNIVERSAL Captive Cushion Adjustment Seal

A, N & R Cylinders



Part #	I.D. X C.S.	List Price
HS-C408-1	.204 X .072	\$ 5.59
HS-C408-1V	.204 X .072	6.73
HS-C408-2	.298 X .072	5.59
HS-C408-2V	.298 X .072	6.73
HS-C408-3	.420 X .072	5.59
HS-C408-3V	.420 X .072	6.73
HS-C408-4	.542 X .072	5.59
HS-C408-4V	.542 X .072	6.73

Used on Captive Cushion Adjustment Valves for precise adjustment under pressure over a broad range of operating conditions. Available in both 90A material - Nitrile and Fluorocarbon.

HYDRO-LINE®

UNIVERSAL Piston Kits

Nitrile

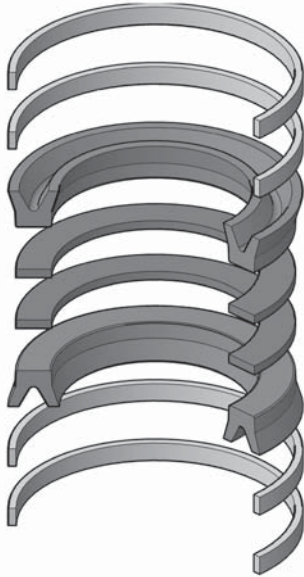

Kit Includes:

- 2 NBR U-seals
- 2 URE Back-up Rings
- 4 PTFE Tube End Seals

N2 & N5 Cylinders Fluorocarbon

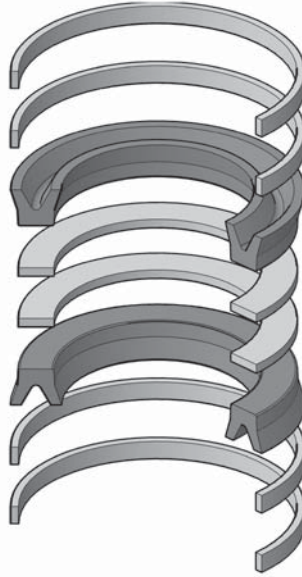

Kit Includes:

- 2 FC U-seals
- 2 PTFE Back-up Rings
- 4 PTFE Tube End Seals

Piston Ring

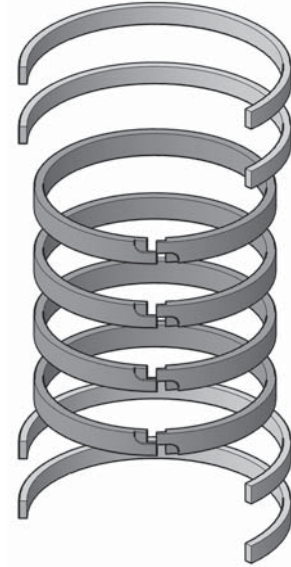

Kit Includes:

- 4 Cast Iron Piston Rings
- 4 PTFE Tube End Seals

Bore Dia.	(NBR) Kit #	List Price	(FC) Kit #	List Price	(PR) Kit #	List Price
1-1/2"	HSKN25-512-03	\$ 38.09	HSKN25-512-03V	\$ 74.99	HSKN25-511-03	\$ 102.81
2"	HSKN25-512-04	42.73	HSKN25-512-04V	108.93	HSKN25-511-04	115.04
2-1/2"	HSKN25-512-05	44.57	HSKN25-512-05V	117.42	HSKN25-511-05	117.23
3-1/4"	HSKN25-512-065	58.20	HSKN25-512-065V	124.83	HSKN25-511-065	123.17
4"	HSKN25-512-08	68.51	HSKN25-512-08V	154.12	HSKN25-511-08	138.85
5"	HSKN25-512-10	89.75	HSKN25-512-10V	169.70	HSKN25-511-10	164.93
6"	HSKN25-512-12	101.91	HSKN25-512-12V	251.58	HSKN25-511-12	182.27
7"	HSKN25-512-14	120.76	HSKN25-512-14V	302.10	HSKN25-511-14	182.10
8"	HSKN25-512-16	170.62	HSKN25-512-16V	250.34	HSKN25-511-16	221.73



HYDRO-LINE®

Sales Part Number	Description	Rod Size	Bore Size	List Price
HN5-655-05	Bushing w/ spacer	5/8		\$ 114.74
HN5-655-08	Bushing w/ spacer	1		144.43
HN5-655-11	Bushing w/ spacer	1-3/8		153.87
HN5-655-14	Bushing w/ spacer	1-3/4		177.46
HN5-655-16	Bushing w/ spacer	2		185.50
HN5-655-20	Bushing w/ spacer	2-1/2		199.70
HN5-655-24	Bushing w/ spacer	3		297.37
HN5-655-28	Bushing w/ spacer	3-1/2		348.35
HN5-655-32	Bushing w/ spacer	4		382.32
HN5-655-36	Bushing w/ spacer	4-1/2 x 2.57ht		543.76
HN5-655-36A	Bushing w/ spacer	4-1/2 x 1.88ht		543.76
HN5-655-40	Bushing w/ spacer	5		662.69
HN5-655-44	Bushing w/ spacer	5-1/2		713.68
HN5-665-05	Rod Gland Kit	5/8		129.71
HN5-665-05V	Rod Gland Kit	5/8		147.85
HN5-665-08	Rod Gland Kit	1		161.01
HN5-665-08V	Rod Gland Kit	1		180.68
HN5-665-11	Rod Gland Kit	1-3/8		172.24
HN5-665-11V	Rod Gland Kit	1-3/8		197.52
HN5-665-14	Rod Gland Kit	1-3/4		200.26
HN5-665-14V	Rod Gland Kit	1-3/4		225.79
HN5-665-16	Rod Gland Kit	2		208.51
HN5-665-16V	Rod Gland Kit	2		238.51
HN5-665-20	Rod Gland Kit	2-1/2		226.29
HN5-665-20V	Rod Gland Kit	2-1/2		259.06
HN5-665-24	Rod Gland Kit	3		340.90
HN5-665-24V	Rod Gland Kit	3		397.62
HN5-665-28	Rod Gland Kit	3-1/2		399.11
HN5-665-28V	Rod Gland Kit	3-1/2		449.98
HN5-665-32	Rod Gland Kit	4		442.35
HN5-665-32V	Rod Gland Kit	4		511.77
HN5-665-36	Rod Gland Kit	4-1/2		626.11
HN5-665-36A	Rod Gland Kit	4-1/2		626.11
HN5-665-36AV	Rod Gland Kit	4-1/2		699.61
HN5-665-36V	Rod Gland Kit	4-1/2		699.61
HN5-665-40	Rod Gland Kit	5		753.39
HN5-665-40V	Rod Gland Kit	5		846.77
HN5-665-44	Rod Gland Kit	5-1/2		817.54
HN5-665-44V	Rod Gland Kit	5-1/2		939.02
HN5-B-650-05	Gland Kit	5/8		112.20
HN5-B-650-08	Gland Kit	1		120.22
HN5-B-650-11	Gland Kit	1-3/8		141.53
HN5-B-650-14	Gland Kit	1-3/4		163.30
HN5-B-650-16	Gland Kit	2		168.86
HN5-B-650-20	Gland Kit	2-1/2		212.73
HN5-B-650-24	Gland Kit	3		226.63
HN5-B-650-28	Gland Kit	3-1/2		402.16
HN5-B-650-32	Gland Kit	4		432.27
HN5-B-650-36	Gland Kit	4-1/2		595.58

HYDRO-LINE®



HYDRO-LINE®

HYDRO-LINE®

Sales Part Number	Description	Rod Size	Bore Size	List Price
HN5-B-650-36A	Gland Kit	4-1/2		\$ 468.58
HN5-B-650-40	Gland Kit	5		654.37
HN5-B-650-44	Gland Kit	5-1/2		683.13
HS-C124-03	Tube End Seals		1-1/2	10.66
HS-C124-04	Tube End Seals		2	12.96
HS-C124-05	Tube End Seals		2-1/2	15.00
HS-C124-065	Tube End Seals		3-1/4	18.98
HS-C124-08	Tube End Seals		4	20.40
HS-C124-10	Tube End Seals		5	22.45
HS-C124-12	Tube End Seals		6	23.18
HS-C124-STRIP	Tube End Seals		0.068cs x 0.140w PTFE strip (sold by the foot)	15.07
HS-C221-02	Tube End Seals		1	8.09
HS-C221-03	Tube End Seals		1-1/2	8.67
HS-C221-04	Tube End Seals		2	9.44
HS-C221-05	Tube End Seals		2-1/2	10.42
HS-C221-065	Tube End Seals		3-1/4	11.24
HS-C221-08	Tube End Seals		4	12.69
HS-C221-10	Tube End Seals		5	17.17
HS-C221-12	Tube End Seals		6	22.10
HS-C221-STRIP	Tube End Seals		0.063cs x 0.093w PTFE strip (sold by the foot)	9.70
HS-C255-03	Tube End Seals		1-1/2	11.44
HS-C255-04	Tube End Seals		2	13.23
HS-C255-05	Tube End Seals		2-1/2	13.96
HS-C255-065	Tube End Seals		3-1/4	14.38
HS-C255-08	Tube End Seals		4	16.32
HS-C255-10	Tube End Seals		5	17.38
HS-C255-12	Tube End Seals		6	18.13
HS-C255-14	Tube End Seals		7	18.98
HS-C255-16	Tube End Seals		8	22.09
HS-C408-1	Captive Cushion Adjustment Seal	0.204 ID x 0.072 CS		5.59
HS-C408-1V	Captive Cushion Adjustment Seal	0.204 ID x 0.072 CS		6.73
HS-C408-2	Captive Cushion Adjustment Seal	0.298 ID x 0.072 CS		5.59
HS-C408-2V	Captive Cushion Adjustment Seal	0.298 ID x 0.072 CS		6.73
HS-C408-3	Captive Cushion Adjustment Seal	0.420 ID x 0.072 CS		5.59
HS-C408-3V	Captive Cushion Adjustment Seal	0.420 ID x 0.072 CS		6.73
HS-C408-4	Captive Cushion Adjustment Seal	0.542 ID x 0.072 CS		5.59
HS-C408-4V	Captive Cushion Adjustment Seal	0.542 ID x 0.072 CS		6.73
HS-E304-03	Tube End Seals		1-1/2	2.52
HS-E304-04	Tube End Seals		2	2.63
HS-E304-065	Tube End Seals		3-1/4	2.94
HS-E304-08	Tube End Seals		4	3.32
HSKA5-512-03	Piston Kit		1-1/2	25.39
HSKA5-512-03V	Piston Kit		1-1/2	51.36
HSKA5-512-04	Piston Kit		2	27.05
HSKA5-512-04V	Piston Kit		2	53.22
HSKA5-512-05	Piston Kit		2-1/2	29.14
HSKA5-512-05V	Piston Kit		2-1/2	62.76
HSKA5-512-065	Piston Kit		3-1/4	31.43
HSKA5-512-065V	Piston Kit		3-1/4	70.77
HSKA5-512-08	Piston Kit		4	36.59



HYDRO-LINE®

HYDRO-LINE®

Sales Part Number	Description	Rod Size	Bore Size	List Price
HSKA5-512-08V	Piston Kit		4	\$ 76.93
HSKA5-512-10	Piston Kit		5	45.72
HSKA5-512-10V	Piston Kit		5	90.22
HSKA5-512-12	Piston Kit		6	53.84
HSKA5-512-12V	Piston Kit		6	147.63
HSKE2-512-04	Piston Kit		2	25.76
HSKE2-512-065	Piston Kit		3-1/4	24.76
HSKE2-512-08	Piston Kit		4	43.20
HSKE2-660-05	Rod Kit	5/8		4.28
HSKE2-660-08	Rod Kit	1		4.76
HSKE2-660-11	Rod Kit	1-3/8		5.29
HSKN2-511-03	Piston Ring Kit		1-1/2	80.46
HSKN2-511-04	Piston Ring Kit		2	91.74
HSKN2-511-05	Piston Ring Kit		2-1/2	93.22
HSKN2-511-065	Piston Ring Kit		3-1/4	98.40
HSKN2-511-08	Piston Ring Kit		4	110.77
HSKN2-511-10	Piston Ring Kit		5	134.80
HSKN2-511-12	Piston Ring Kit		6	142.37
HSKN2-511-14	Piston Ring Kit		7	159.46
HSKN2-511-16	Piston Ring Kit		8	196.06
HSKN2-511-20	Piston Ring Kit		10	409.45
HSKN2-511-24	Piston Ring Kit		12	553.86
HSKN2-512-03	Piston Kit		1-1/2	32.41
HSKN2-512-03V	Piston Kit		1-1/2	63.08
HSKN2-512-04	Piston Kit		2	39.28
HSKN2-512-04V	Piston Kit		2	82.82
HSKN2-512-05	Piston Kit		2-1/2	42.40
HSKN2-512-05V	Piston Kit		2-1/2	88.04
HSKN2-512-065	Piston Kit		3-1/4	40.75
HSKN2-512-065V	Piston Kit		3-1/4	100.07
HSKN2-512-08	Piston Kit		4	48.96
HSKN2-512-08V	Piston Kit		4	118.37
HSKN2-512-10	Piston Kit		5	62.90
HSKN2-512-10V	Piston Kit		5	131.08
HSKN2-512-12	Piston Kit		6	70.69
HSKN2-512-12V	Piston Kit		6	174.14
HSKN2-512-14	Piston Kit		7	107.93
HSKN2-512-14V	Piston Kit		7	256.51
HSKN2-512-16	Piston Kit		8	136.69
HSKN2-512-16V	Piston Kit		8	283.36
HSKN2-512-20	Piston Kit		10	153.71
HSKN2-512-20V	Piston Kit		10	527.14
HSKN2-512-24	Piston Kit		12	241.61
HSKN2-512-24V	Piston Kit		12	781.58
HSKN25-511-03	Piston Kit		1-1/2	102.81
HSKN25-511-04	Piston Kit		2	115.04
HSKN25-511-05	Piston Kit		2-1/2	117.23
HSKN25-511-065	Piston Kit		3-1/4	123.17
HSKN25-511-08	Piston Kit		4	138.85
HSKN25-511-10	Piston Kit		5	164.93
HSKN25-511-12	Piston Kit		6	182.27

HYDRO-LINE®

HYDRO-LINE®

Sales Part Number	Description	Rod Size	Bore Size	List Price
HSKN25-511-14	Piston Kit		7	\$ 182.10
HSKN25-511-16	Piston Kit		8	221.73
HSKN25-512-03	Piston Kit		1-1/2	38.09
HSKN25-512-03V	Piston Kit		1-1/2	74.99
HSKN25-512-04	Piston Kit		2	42.73
HSKN25-512-04V	Piston Kit		2	108.93
HSKN25-512-05	Piston Kit		2-1/2	44.57
HSKN25-512-05V	Piston Kit		2-1/2	117.42
HSKN25-512-065	Piston Kit		3-1/4	58.20
HSKN25-512-065V	Piston Kit		3-1/4	124.83
HSKN25-512-08	Piston Kit		4	68.51
HSKN25-512-08V	Piston Kit		4	154.12
HSKN25-512-10	Piston Kit		5	89.75
HSKN25-512-10V	Piston Kit		5	169.70
HSKN25-512-12	Piston Kit		6	101.91
HSKN25-512-12V	Piston Kit		6	251.58
HSKN25-512-14	Piston Kit		7	120.76
HSKN25-512-14V	Piston Kit		7	302.10
HSKN25-512-16	Piston Kit		8	170.62
HSKN25-512-16V	Piston Kit		8	250.34
HSKN25-665-05	Rod Kit	5/8		11.19
HSKN25-665-05V	Rod Kit	5/8		38.80
HSKN25-665-08	Rod Kit	1		11.64
HSKN25-665-08V	Rod Kit	1		40.37
HSKN25-665-11	Rod Kit	1-3/8		14.86
HSKN25-665-11V	Rod Kit	1-3/8		51.26
HSKN25-665-14	Rod Kit	1-3/4		18.76
HSKN25-665-14V	Rod Kit	1-3/4		57.55
HSKN25-665-16	Rod Kit	2		20.97
HSKN25-665-16V	Rod Kit	2		60.98
HSKN25-665-20	Rod Kit	2-1/2		25.08
HSKN25-665-20V	Rod Kit	2-1/2		69.38
HSKN2-661-05	Rod Kit	5/8		9.68
HSKN2-661-05V	Rod Kit	5/8		35.85
HSKN2-661-08	Rod Kit	1		9.61
HSKN2-661-08V	Rod Kit	1		38.06
HSKN2-661-11	Rod Kit	1-3/8		11.73
HSKN2-661-11V	Rod Kit	1-3/8		42.40
HSKN2-661-14	Rod Kit	1-3/4		13.78
HSKN2-661-14V	Rod Kit	1-3/4		49.71
HSKN2-661-16	Rod Kit	2		15.26
HSKN2-661-16V	Rod Kit	2		52.49
HSKN2-661-20	Rod Kit	2-1/2		22.89
HSKN2-661-20V	Rod Kit	2-1/2		58.58
HSKN5-511-03	Piston Ring Kit		1-1/2	79.93
HSKN5-511-04	Piston Ring Kit		2	87.13
HSKN5-511-05	Piston Ring Kit		2-1/2	87.84
HSKN5-511-065	Piston Ring Kit		3-1/4	90.53
HSKN5-511-08	Piston Ring Kit		4	103.74
HSKN5-511-10	Piston Ring Kit		5	126.28



HYDRO-LINE®

HYDRO-LINE®

Sales Part Number	Description	Rod Size	Bore Size	List Price
HSKN5-511-12	Piston Ring Kit		6	\$ 142.37
HSKN5-511-14	Piston Ring Kit		7	168.24
HSKN5-511-16	Piston Ring Kit		8	213.50
HSKN5-512-03	Piston Kit		1-1/2	25.19
HSKN5-512-03V	Piston Kit		1-1/2	62.55
HSKN5-512-04	Piston Kit		2	34.64
HSKN5-512-04V	Piston Kit		2	86.57
HSKN5-512-05	Piston Kit		2-1/2	37.06
HSKN5-512-05V	Piston Kit		2-1/2	88.04
HSKN5-512-065	Piston Kit		3-1/4	40.75
HSKN5-512-065V	Piston Kit		3-1/4	91.95
HSKN5-512-08	Piston Kit		4	48.85
HSKN5-512-08V	Piston Kit		4	119.01
HSKN5-512-10	Piston Kit		5	59.57
HSKN5-512-10V	Piston Kit		5	139.75
HSKN5-512-12	Piston Kit		6	61.98
HSKN5-512-12V	Piston Kit		6	165.46
HSKN5-512-14	Piston Kit		7	117.23
HSKN5-512-14V	Piston Kit		7	236.14
HSKN5-512-16	Piston Kit		8	164.44
HSKN5-512-16V	Piston Kit		8	265.88
HSKN5-512-P-05	Piston Kit		2-1/2	42.20
HSKN5-512-P-16	Piston Kit		8	211.29
HSKN5-660-04	Rod Kit	1/2		7.88
HSKN5-660-04V	Rod Kit	1/2		29.02
HSKN5-660-05	Rod Kit	5/8		9.65
HSKN5-660-05V	Rod Kit	5/8		34.64
HSKN5-660-08	Rod Kit	1		9.81
HSKN5-660-08V	Rod Kit	1		36.40
HSKN5-660-11	Rod Kit	1-3/8		12.30
HSKN5-660-11V	Rod Kit	1-3/8		47.57
HSKN5-660-14	Rod Kit	1-3/4		15.51
HSKN5-660-14V	Rod Kit	1-3/4		49.32
HSKN5-660-16	Rod Kit	2		17.37
HSKN5-660-16V	Rod Kit	2		52.56
HSKN5-660-20	Rod Kit	2-1/2		19.11
HSKN5-660-20V	Rod Kit	2-1/2		59.31
HSKN5-660-24	Rod Kit	3		19.87
HSKN5-660-24V	Rod Kit	3		77.34
HSKN5-660-28	Rod Kit	3-1/2		21.80
HSKN5-660-28V	Rod Kit	3-1/2		90.36
HSKN5-660-32	Rod Kit	4		27.35
HSKN5-660-32V	Rod Kit	4		94.43
HSKN5-660-36	Rod Kit	4-1/2		29.46
HSKN5-660-36V	Rod Kit	4-1/2		99.68
HSKN5-660-40	Rod Kit	5		43.61
HSKN5-660-40V	Rod Kit	5		119.83
HSKN5-660-44	Rod Kit	5-1/2		59.46
HSKN5-660-44V	Rod Kit	5-1/2		135.32
HSKN5-660-P-04	Rod Kit	1/2	1	13.67



HYDRO-LINE®

HYDRO-LINE®

Sales Part Number	Description	Rod Size	Bore Size	List Price
HSKN5-660-P-04V	Rod Kit	1/2	1	\$ 54.83
HSKN5-660-P-05AV	Rod Kit	5/8	1	55.19
HSKN5-660-P-05V	Rod Kit	5/8	1.5 & UP	58.27
HSKN5-660-P-08	Rod Kit	1	2 & UP	15.19
HSKN5-660-P-08V	Rod Kit	1	2 & UP	66.15
HSKN5-660-P-11V	Rod Kit	1-3/8	2.5 & UP	81.05
HSKN5-660-P-14	Rod Kit	1-3/4		18.85
HSKN5-660-P-14V	Rod Kit	1-3/4		89.31
HSKN5-660-P-16V	Rod Kit	2		93.01
HSKN5-660-P-20	Rod Kit	2-1/2		28.37
HSKN5-660-P-20V	Rod Kit	2-1/2		135.63
HSKN5-660-P-24V	Rod Kit	3		156.21
HSKN5-660-P-28	Rod Kit	3-1/2		34.89
HSKN5-660-P-28V	Rod Kit	3-1/2		174.42
HSKN5-660-P-32V	Rod Kit	4		210.65
HSKN5-660-P-36V	Rod Kit	4-1/2		225.92
HSKN5-660-P-40V	Rod Kit	5		231.60
HSKN5-660-P-44V	Rod Kit	5-1/2		236.78
HSKN5-681-05	Rod Kit	5/8		16.25
HSKN5-681-05A	Rod Kit	5/8	1	14.19
HSKN5-681-08	Rod Kit	1		17.83
HSKN5-681-11	Rod Kit	1-3/8		19.87
HSKN5-681-14	Rod Kit	1-3/4		21.26
HSKN5-681-16	Rod Kit	2		27.67
HSKN5-681-20	Rod Kit	2-1/2		38.97
HSKN5-681-24	Rod Kit	3		42.48
HSKN5-681-28	Rod Kit	3-1/2		46.53
HSKN5-681-32	Rod Kit	4		54.56
HSKN5-681-36	Rod Kit	4-1/2		71.68
HSKN5-681-40	Rod Kit	5		75.08
HSKN5-681-44	Rod Kit	5-1/2		89.34
HSKR2-662-05A	Rod Kit	5/8	1	8.48
HSKR2-662-05AV	Rod Kit	5/8	1	35.77
HSKR2-662-08	Rod Kit	1	1.5,2,2.5	9.25
HSKR2-662-08V	Rod Kit	1	1.5,2,2.5	36.50
HSKR2-662-11	Rod Kit	1-3/8	2, 2.5	11.27
HSKR2-662-11V	Rod Kit	1-3/8	2, 2.5	47.03
HSKR2-662-14	Rod Kit	1-3/4	2.5	13.85
HSKR2-662-14V	Rod Kit	1-3/4	2.5	48.33
HSKR2-662-P-05AV	Rod Kit	5/8	1	55.18
HSKR2-662-P-08V	Rod Kit	1	1.5,2,2.5	66.70
HSKR2-662-P-11V	Rod Kit	1-3/8	2, 2.5	80.06
HSKR2-662-P-14V	Rod Kit	1-3/4	2.5	89.65
HSKR2-681-05A	Rod Kit	5/8	1	14.19
HSKR2-681-08	Rod Kit	1	1.5,2,2.5	17.61
HSKR2-681-11	Rod Kit	1-3/8	2, 2.5	17.83
HSKR2-681-14	Rod Kit	1-3/4	2.5	18.62
HSKR5-511-02	Piston Ring Kit		1	86.60
HSKR5-511-03	Piston Ring Kit		1-1/2	58.10
HSKR5-511-04	Piston Ring Kit		2	59.83



HYDRO-LINE®

Sales Part Number	Description	Rod Size	Bore Size	List Price
HSKR5-511-05	Piston Ring Kit		2-1/2	\$ 60.81
HSKR5-511-065	Piston Ring Kit		3-1/4	70.40
HSKR5-511-08	Piston Ring Kit		4	79.35
HSKR5-511-10	Piston Ring Kit		5	102.62
HSKR5-511-12	Piston Ring Kit		6	113.73
HSKR5-511-16	Piston Ring Kit		8	133.88
HSKR5-511-20	Piston Ring Kit		10	381.35
HSKR5-511-24	Piston Ring Kit		12	530.57
HSKR5-512-02	Piston Kit		1	25.99
HSKR5-512-02V	Piston Kit		1	55.49
HSKR5-512-03	Piston Kit		1-1/2	27.45
HSKR5-512-03V	Piston Kit		1-1/2	58.10
HSKR5-512-04	Piston Kit		2	30.04
HSKR5-512-04V	Piston Kit		2	81.96
HSKR5-512-05	Piston Kit		2-1/2	32.81
HSKR5-512-05V	Piston Kit		2-1/2	83.78
HSKR5-512-065	Piston Kit		3-1/4	36.40
HSKR5-512-065V	Piston Kit		3-1/4	87.67
HSKR5-512-08	Piston Kit		4	42.69
HSKR5-512-08V	Piston Kit		4	112.71
HSKR5-512-10	Piston Kit		5	54.06
HSKR5-512-10V	Piston Kit		5	125.54
HSKR5-512-12	Piston Kit		6	60.33
HSKR5-512-12V	Piston Kit		6	163.82
HSKR5-512-16	Piston Kit		8	156.94
HSKR5-512-16V	Piston Kit		8	310.97
HSKR5-512-20	Piston Kit		10	153.71
HSKR5-512-20V	Piston Kit		10	527.14
HSKR5-512-24	Piston Kit		12	241.61
HSKR5-512-24V	Piston Kit		12	781.58
HSKR5-512-28	Piston Kit		14	347.56
HSKR5-512-28V	Piston Kit		14	852.74

HYDRO-LINE®